

Panasonic

Advanced Hybrid System

Installation Manual

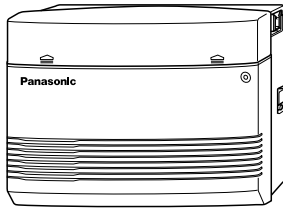

KX-TA308

MODEL **KX-TA616**



This manual was printed
with soy based ink.

**Please read this manual before connecting
the Advanced Hybrid System.**

System Highlights

System Capacity

		<KX-TA308>	<KX-TA616>
Basic System	Extensions	8	16
	Outside (CO) lines	3	6
Expansion	Maximum extensions	24	24
	Maximum outside (CO) lines	6	6

Special System Points

System Expansion

This system can expand the outside (CO) lines (KX-TA308 only) and extension capacity by installing an optional card.

☞ 2-24

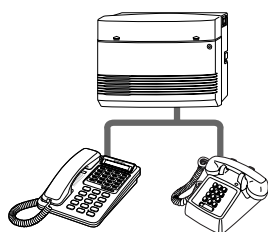

Direct Backup Power Supply

Car batteries can be connected directly to this system as a backup power supply in the event of a power failure.

To supply backup power, optional cables are required.

☞ 2-23

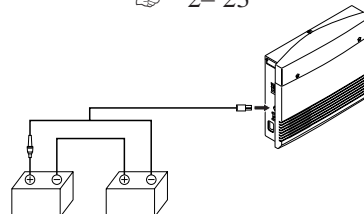

Hybrid

This system can accept Panasonic analog proprietary telephones. Also, single line devices such as single line telephones, facsimiles and data terminals can be connected.

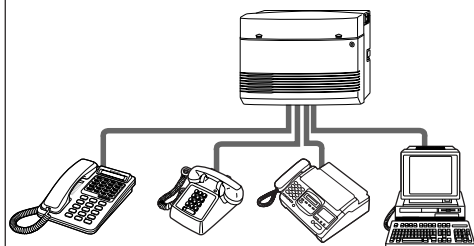

Calling from the outside (Direct Inward System Access)

External callers can call extensions in the system. If you install an optional card, an outgoing message will greet the caller and give information about how to access an extension.

☞ 3-17

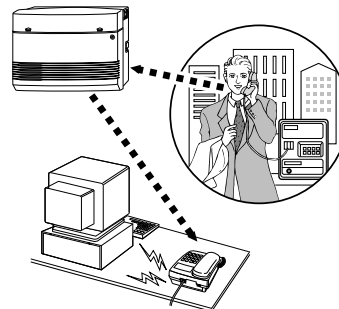

Precautions

- Keep the unit away from heating appliances and electrical noise generating devices such as fluorescent lamps, motors and televisions. These noise sources can interfere with the performance of the Advanced Hybrid System.
- This unit should be kept free of dust, moisture, high temperature (more than 40 °C {104 °F}) and vibration, and should not be exposed to direct sunlight.
- Never attempt to insert wires, pins, etc. into the vents or other holes of this unit.
- If there is any trouble, disconnect the unit from the telephone line. Plug the telephone directly into the telephone line. If the telephone operates properly, do not reconnect the unit to the line until the trouble has been repaired. If the telephone does not operate properly, chances are that the trouble is in the telephone system, and not in the unit.
- Do not use benzine, thinner, or the like, or any abrasive powder to clean the cabinet. Wipe it with a soft cloth.

WARNING

THIS UNIT MAY ONLY BE INSTALLED AND SERVED BY QUALIFIED SERVICE PERSONNEL.

WHEN A FAILURE OCCURS WHICH RESULTS IN THE INTERNAL PARTS BECOMING ACCESSIBLE, DISCONNECT THE POWER SUPPLY CORD IMMEDIATELY AND RETURN THIS UNIT TO YOUR DEALER.

DISCONNECT THE TELECOM CONNECTION BEFORE DISCONNECTING THE POWER CONNECTION PRIOR TO RELOCATING THE EQUIPMENT, AND RECONNECT THE POWER FIRST.

THIS UNIT IS EQUIPPED WITH AN EARTHING CONTACT PLUG. FOR SAFETY REASONS THIS PLUG MUST ONLY BE CONNECTED TO AN EARTHING CONTACT SOCKET WHICH HAS BEEN INSTALLED ACCORDING TO REGULATIONS.

THE POWER SUPPLY CORD IS USED AS THE MAIN DISCONNECT DEVICE, ENSURE THAT THE SOCKET-OUTLET IS LOCATED/INSTALLED NEAR THE EQUIPMENT AND IS EASILY ACCESSIBLE.

TO PREVENT FIRE OR SHOCK HAZARD, DO NOT EXPOSE THIS PRODUCT TO RAIN OR MOISTURE.

Precautions

For your future reference

SERIAL NO. _____ DATE OF PURCHASE _____

(found on the bottom of the unit)

NAME OF DEALER _____

DEALER'S ADDRESS _____

Note • This Installation Manual does not show complete model number that indicate the country where your models should be used. The model number of your unit is found on the label affixed to the unit.

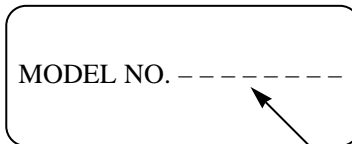

(label)

Introduction

Structure of the Manual

This manual consists of the following sections:

Section 1. Basic System Construction

Provides general information on the system including connection diagrams.

Section 2. Installation

Contains the system installation and wiring instructions, as well as how to install the optional cards.

Section 3. Features

Describes the optional and programmable features in alphabetical order. It also provides information about the conditions, required System Programming, connection references, related features and operating instructions references for every feature.

Section 4. System Programming

Describes the steps required to assign features to extensions or to the system.

Section 5. Appendix

Provides specifications and the default values of the System Programming.

Section 6. Troubleshooting

Provides information for system and telephone troubleshooting.

Section 7. Programming Tables

Provides programming tables for user-programmed data.

Description of the Symbols Mainly Used in this manual



Additional information and conditions.



The feature or program references.

Contents

Section 1 Basic System Construction

Section 2 Installation

2.1	Before Installation	2-2
2.2	Unpacking	2-4
2.3	Names and Locations	2-4
2.4	Wall Mounting.....	2-5
2.5	Frame Ground Connection	2-6
2.6	Opening the Top Front Cover	2-6
2.7	Outside (CO) Line Connection	2-7
2.8	Extension Connection	2-9
2.9	External Pager (Paging Equipment) Connection.....	2-10
2.10	External Music Connection.....	2-11
2.11	Paralleled Telephone Connection.....	2-12
2.12	Polarity Sensitive Telephone Connection	2-13
2.13	Printer and PC Connection.....	2-14
2.14	Location of Optional Cards.....	2-17
2.15	OGM/FAX Detection Card Installation	2-17
2.16	Doorphone and Door Opener Connection.....	2-19
2.17	Backup Batteries Connection.....	2-23
2.18	Installing a 3-CO Line & 8 Ext Expansion Card (KX-TA30877) and 8 SLT Extn. Expansion Card (KX-TA30874)	2-24
2.19	Auxiliary Connection for Power Failure Transfer	2-29
2.20	Securing the Cords.....	2-29
2.21	Closing the Front Cover	2-30
2.22	Starting the System for the First Time	2-31
2.23	System Restart.....	2-33
2.24	System Data Clear.....	2-34

Section 3 Features

A	Absent Message Capability	3-2
	Account Code Entry	3-2
	Alternate Calling – Ring/Voice	3-3
	Automatic Callback Busy (Camp-On)	3-3
	Automatic Outside (CO) Line Access Number.....	3-4
	Automatic Route Selection (ARS).....	3-4
B	Busy Station Signaling (BSS)	3-8
C	Call Forwarding.....	3-9
	Calling Party Control (CPC) Signal Detection	3-10
	Call Park	3-10
	Call Pickup	3-11
	Call Splitting.....	3-11
	Call Transfer – to Extension.....	3-12
	Call Transfer – to Outside (CO) Line	3-12

Contents

C	Call Waiting	3-13
	Conference (3-party)	3-14
	Conference (5-party)	3-15
D	Data Line Security	3-15
	Date and Time Setting	3-16
	Direct In Line (DIL)	3-16
	Direct Inward System Access (DISA)	3-17
	Display Contrast Adjustment (KX-T7330/KX-T7030/KX-T7130/KX-T7033 only)	3-24
	Distinctive Dial Tones	3-24
	Do Not Disturb (DND)	3-25
	Door Opener	3-25
	Doorphone Call	3-26
	DSS Console	3-27
E	Emergency Call	3-27
	Executive Busy Override	3-28
	Extension Button Confirmation (KX-T7330/KX-T7030/KX-T7130/KX-T7033 only)	3-28
	Extension Group	3-29
	Extension Password / System Password	3-29
	External Feature Access	3-30
F	Flash	3-30
	Flexible Buttons	3-31
H	Handset/Headset Selection (KX-T7330/KX-T7030/KX-T7130/KX-T7033 only)	3-32
	Handsfree Answerback	3-32
	Handsfree Operation	3-32
	Hold	3-33
	Hookswitch Flash	3-34
	Host PBX Access	3-34
I	Intercept Routing	3-35
	Intercom Calling	3-35
L	Language Selection	3-36
	Limited Call Duration	3-36
	Line Access Buttons	3-37
	Log-In/Log-Out	3-38
M	Message Waiting	3-38
	Microphone Mute	3-39
	Music on Hold / Background Music (BGM)	3-39
O	One-Touch Dialing	3-39
	Operator / Manager Extension	3-40
	Operator Call	3-40
	Outgoing Message (OGM)	3-41
	Outside Calling	3-44
	Outside (CO) Line Ringing Selection	3-45

Contents

P	Paging	3-45
	Paralleled Telephone Connection	3-46
	Personal Speed Dialing	3-46
	Pickup Dialing	3-47
	Polarity Reverse Detection	3-47
	Power Failure Transfer	3-48
	Preferred Line Assignment — Incoming	3-48
	Preferred Line Assignment — Outgoing.....	3-49
	Proprietary Telephone Setting Data Default Set	3-49
	Pulse to Tone Conversion	3-50
R	Receiving Calls.....	3-50
	Redial	3-50
	Ring Pattern Selection.....	3-51
	Room Monitor	3-52
S	Secret Dialing	3-52
	Self-Extension Number Confirmation (KX-T7330/KX-T7030/KX-T7130/KX-T7033 only).....	3-53
	Station Feature Clear	3-53
	Station Hunting.....	3-54
	Station Lock.....	3-55
	Station Message Detail Recording (SMDR)	3-56
	System Data Default Set	3-57
	System Speed Dialing	3-58
T	Timed Reminder	3-58
	Time (Day/Night/Lunch) Service.....	3-59
	Toll Restriction	3-60
	Toll Restriction for System Speed Dialing.....	3-62
	Toll Restriction Override by Account Codes	3-63
	Toll Restriction – Station Lock Boundary Class.....	3-64
U	Uniform Call Distribution (UCD)	3-64
V	Voice Mail Integration for KX-TVP75/KX-TVP100.....	3-68
	Volume Control	3-71
W	Walking COS	3-71

Section 4 System Programming

4.1	Before System Programming	4-2
4.2	System Programming.....	4-5
	[000] Date and Time Setting.....	4-5
	[001] System Speed Dialing Entry	4-5
	[002] System Password.....	4-6
	[003] DSS Console Port Assignment.....	4-7
	[004] Paired Telephone Assignment for DSS Console	4-7
	[005] One-Touch Transfer Using a DSS Button	4-8
	[006] Time (Day/Night/Lunch) Service Changing Mode	4-8

Contents

[007]	Time (Day/Night/Lunch) Service Start Time	4-9
[008]	Operator Assignment	4-10
[009]	Extension Number Assignment	4-10
[010]	LCD Time Display Selection	4-11
[011]	System Speed Dialing Name Setting	4-12
[012]	Second Feature Numbering Plan	4-13
[100]	Hunting Group Set	4-14
[101]	Hunting Type	4-14
[102]	Voice Mail Port for KX-TVP75/KX-TVP100	4-15
[103]	DTMF Integration for KX-TVP75/KX-TVP100	4-15
[104]	Hold Mode Selection	4-17
[105]	Conference Tone	4-17
[106]	External Paging Access Tone	4-18
[107]	DTMF Receiver Check	4-18
[108]	Flash Mode for a Station Locked Extension	4-18
[109]	CO Indicator Assignment	4-19
[110]	Flash Key Mode	4-19
[111]	Hold Music Selection	4-20
[112]	DSS Console Indication Mode	4-20
[113]	Automatic Redial Repeat	4-21
[114]	Automatic Redial Interval Time	4-21
[115]	Extension Ringing Pattern Selection	4-22
[116]	Conference Pattern Selection	4-22
[117]	Call Pickup Tone	4-23
[118]	Pulse Restriction	4-23
[119]	Redialing after Pulse to Tone Conversion	4-23
[120]	Bell Frequency	4-24
[121]	Automatic Outside (CO) Line Access Number Selection	4-24
[122]	Automatic Rotation for Outside (CO) Line Access	4-24
[123]	Break Ratio	4-25
[124]	SLT Ringing Mode Selection	4-25
[125]	Toll Restriction Check for * and #	4-25
[126]	DSS Off-Hook Mode	4-26
[127]	Pickup Group Set	4-26
[200]	Hold Recall Time	4-27
[201]	Transfer Recall Time	4-27
[202]	Call Forwarding Start Time	4-27
[203]	Pickup Dial Delay Time	4-28
[204]	Call Duration Count Start Time	4-28
[205]	Outside-to-Outside (CO-to-CO) Line Duration Time Limit	4-29
[206]	Dialing Start Time	4-29
[207]	Hookswitch Flash Timing Range Selection	4-30
[208]	Interdigit Time	4-30
[210]	DTMF Time	4-31

Contents

[211] No Dial Disconnection	4-31
[212] Outside (CO) Line Duration Time Limit	4-32
[213] Bell Off Detection	4-32
[300] Carrier Excepted Code Assignment	4-33
[301] Toll Restriction — System Speed Dialing Boundary Class ..	4-33
[302]–[305] Toll Restriction — Classes 2 through 5 Denied Codes ..	4-34
[306] Toll Restriction — Exception Codes	4-35
[309] Emergency Dial Number Set	4-35
[310] Account Codes	4-36
[311] Automatic Pause Insertion Codes	4-36
[312] Toll Restriction — Station Lock Boundary Class	4-37
[350] ARS Selection	4-38
[351]–[354] Routes 1 through 4 Selection Codes (Leading Digits)...	4-38
[355]–[358] Routes 1 through 4 Exception Codes	4-39
[359] 1st Carrier Selection Code	4-39
[360] ARS Modification — Removed Digits	4-40
[361] ARS Modification — Added Number	4-40
[362] ARS Dial Tone Pattern Selection	4-41
[363] ARS Interdigit Time	4-41
[364] ARS Outside (CO) Line Group	4-42
[400] Outside (CO) Line Connection Assignment	4-43
[401] Dial Mode	4-43
[402] Pulse Speed Selection	4-44
[403] Host PBX Access Codes	4-44
[404] Outside (CO) Line Group Assignment	4-45
[405]–[407] Flexible Outward Dialing Assignment — Day/Night/Lunch	4-46
[408]–[410] Flexible Ringing Assignment — Day/Night/Lunch	4-47
[411]–[413] Delayed Ringing Assignment — Day/Night/Lunch	4-48
[414]–[416] Outside (CO) Line Mode — Day/Night/Lunch	4-49
[417] Pause Time	4-50
[418] Flash Time	4-51
[419] Automatic Designated Outside (CO) Line Access	4-51
[420] Calling Party Control (CPC) Signal	4-52
[421] CPC Detection for Outgoing Calls	4-53
[422] Disconnect Time	4-53
[423] Outside (CO) Line Ringing Pattern Selection	4-54
[424] Reverse (Polarity) Circuit Assignment	4-55
[500] DISA Incoming Dialing Mode Selection	4-56
[501] DISA Built-in Auto Attendant	4-57
[502] OGM Mode Selection	4-58
[503] FAX Connection	4-59
[504] DISA Delayed Answer Time	4-59

Contents

[505]	DISA Waiting Time after OGM	4-59
[506]	DISA Busy Mode	4-60
[507]	DISA Intercept Mode	4-60
[508]	DISA Ringing Time before Intercept	4-61
[509]	DISA Ringing Time after Intercept	4-61
[510]	DISA No Dial Mode	4-62
[511]	DISA Security Type	4-62
[512]	DISA Security Codes	4-63
[513]	Cyclic Tone Detection	4-63
[514]	Fax Tone Detection	4-64
[515]	Intercept Time for Internal DISA	4-64
[516]	DISA Incoming Assignment	4-65
[517]	DISA AA Wait Time	4-65
[518]	DISA Tone Selection after the Security Code	4-66
[519]	DISA OGM Mute Time	4-66
[520]	UCD Group	4-67
[521]	UCD Busy Waiting Time	4-67
[522]	UCD OGM Message Interval Time	4-67
[523]	UCD Busy Mode	4-68
[524]	UCD Intercept Mode	4-68
[525]	UCD Ringing Time before Intercept	4-69
[526]	UCD Ringing Time after Intercept	4-69
[600]	Extension Group Assignment	4-70
[601]–[603]	TRS – Class of Service Assignment	
—	Day/Night/Lunch	4-70
[604]	Extension Name Setting	4-71
[605]	Account Code Entry Mode	4-72
[606]	Call Transfer to an Outside (CO) Line	4-73
[607]	Call Forwarding to an Outside (CO) Line	4-73
[608]	Executive Busy Override	4-74
[609]	Do Not Disturb Override	4-74
[610]	Paralleled Telephone Connection	4-75
[611]	TAM (Telephone Answering Machine) Extension	4-75
[612]	Room Monitor Assignment	4-76
[613]	Outside (CO) Line Duration Time Limit Selection	4-76
[614]	Internal Pulse Detection	4-77
[615]	LCD Language Assignment	4-78
[700]–[702]	Doorphone Ringing Assignment — Day/Night/Lunch ..	4-79
[703]–[705]	Door Opener Assignment — Day/Night/Lunch	4-80
[706]	Doorphone Ringing / Tone Pattern Selection	4-81
[707]	Doorphone Access Tone Selection	4-81
[708]	Doorphone Ringing Time	4-82
[709]	Door Opener Time	4-82

Contents

[800]	SMDR RS-232C Communication Parameters	4-83
[801]	SMDR Parameter	4-84
[802]	Incoming/Outgoing Call Selection for Printing	4-84
[803]	Secret Speed Dialing / One-Touch Dialing Printing	4-85
[804]	System Data Dump	4-85
[805]	SMDR Account Code Selection	4-86
[806]	SMDR Language Assignment	4-87
[998]	ROM Version	4-87
[999]	System Data Clear	4-88
Section 5	Appendix	
5.1	Default Values	5-2
5.2	Specifications	5-7
Section 6	Troubleshooting	
6.1	While Installing	6-2
6.2	While Connecting.....	6-3
6.3	While Operating.....	6-4
Section 7	Programming Tables	
Template		

Section 1
Basic System Construction

1 Basic System Construction

The KX-TA308 has a basic capacity of 8 extensions and 3 outside (CO) lines, and the KX-TA616 has 16 extensions and 6 outside (CO) lines. It is capable of supporting Panasonic analog proprietary telephones, and single line devices such as single line telephones, facsimiles and data terminals.

To expand its capabilities, the system can be equipped with optional components or customer-supplied peripherals such as an external speaker, external music source (e.g. a radio) and door opener.

System Connection Diagram

■ KX-TA308

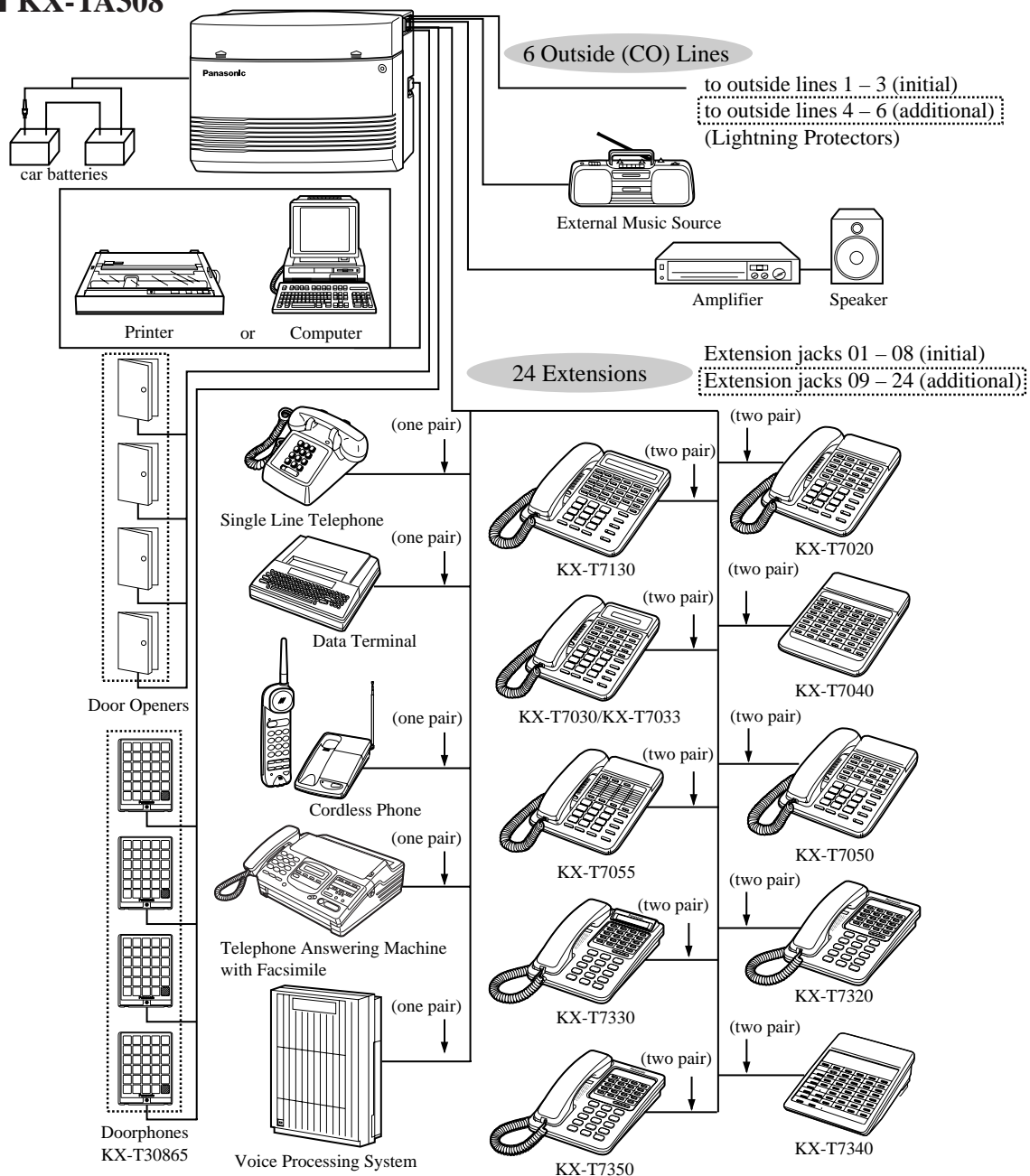

1 Basic System Construction

■ KX-TA616

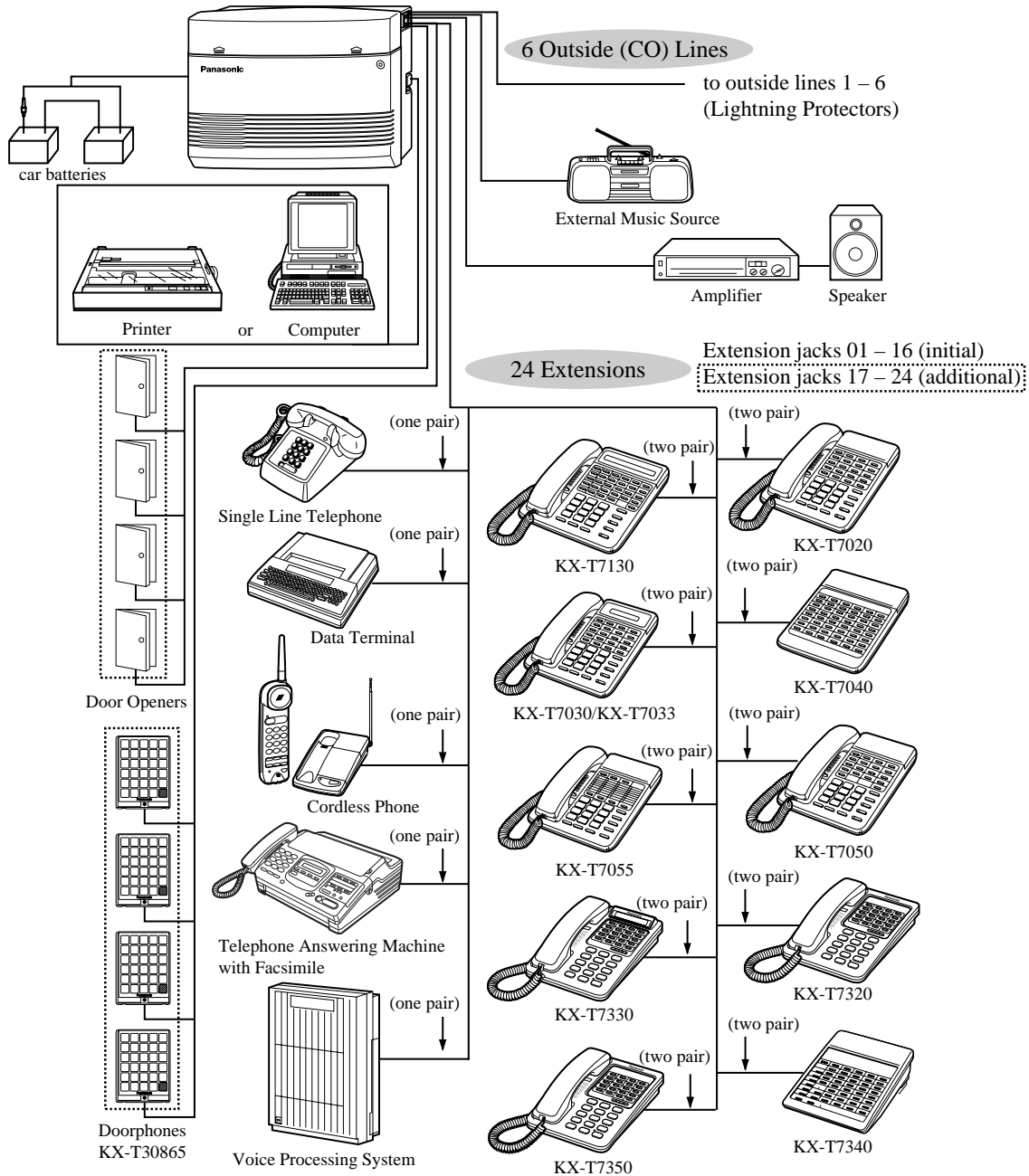

- ! • We recommend connecting a display proprietary telephone at extension jack 01.
- Parallel connection of telephone is possible. (☞ 2.11, Paralleled Telephone Connection)
- A proprietary telephone cannot be connected to extension jacks 17 through 24. Only a single line telephone (SLT) can be connected.

⌋ : needs optional card.

Section 2

Installation

2.1 *Before Installation*

Please read the following notes concerning installation and connection before installing the system and terminal equipment.

Safety Installation Instructions

When installing telephone wiring, basic safety precautions should always be followed to reduce the risk of fire, electric shock and injury to persons, including the following:

1. Never install telephone wiring during a lightning storm.
2. Never install telephone jacks in wet locations unless the jack is specifically designed for wet locations.
3. Never touch uninsulated telephone wires or terminals unless the telephone line has been disconnected at the network interface.
4. Use caution when installing or modifying telephone lines.

Installation Precautions

This system is designed for wall mounting only. Avoid installing in the following places. (Doing so may result in malfunction, noise, or discoloration.)

1. In direct sunlight and hot, cold, or humid places. (Temperature range: 0 °C – 40 °C {32 °F – 104 °F})
2. Sulfuric gases produced in areas where there are thermal springs, etc. may damage the equipment or contacts.
3. Places in which shocks or vibrations are frequent or strong.
4. Dusty places, or places where water or oil may come into contact with the system.
5. Near high-frequency generating devices such as sewing machines or electric welders.
6. On or near computers, telexes, or other office equipment, as well as microwave ovens or air conditioners. (It is preferable not to install the system in the same room with the above equipment.)
7. Install at least 1.8 m {6 feet} away from radios and televisions. (Both the system and Panasonic proprietary telephones)
8. Do not obstruct area around the system (for reasons of maintenance and inspection — be especially careful to allow space for cooling above and at the sides of the system).

Wiring Precautions

Be sure to follow these instructions when wiring the unit:

1. Do not wire the telephone cable in parallel with an AC power source, computer, telex, etc. If the cables are run near those wires, shield the cables with metal tubing or use shielded cables and ground the shields.
2. If cables are run on the floor, use protectors to prevent the wires from being stepped on. Avoid wiring under carpets.
3. Avoid using the same power supply outlet for computers, telexes, and other office equipment. Otherwise, the system operation may be interrupted by the induction noise from such equipment.

2.1 Before Installation

4. Please use one pair telephone wire for extension connection of (telephone) equipment such as single line telephones, data terminals, answering machines, computers, voice processing systems, etc., except Panasonic proprietary telephones (e.g. KX-T7330).
5. Unplug the system during wiring. After all of the wiring is completed, plug in the system.
6. Mis-wiring may cause the system to operate improperly. Refer to Section 6.1 "While Installing" and Section 6.2 "While Connecting".
7. If an extension does not operate properly, disconnect the telephone from the extension line and then connect again, or turn off the Power Switch of the system and then on again.
8. The system is equipped with a 3-wire grounding type plug. This is a safety feature. If you are unable to insert the plug into the outlet, contact your electrician to replace your obsolete outlet. Do not defeat the purpose of the grounding-type plug.
9. Outside (CO) lines should be installed with lightning protectors. For details, refer to Section 2.7 "Outside (CO) Line Connection", Installing Lightning Protectors.

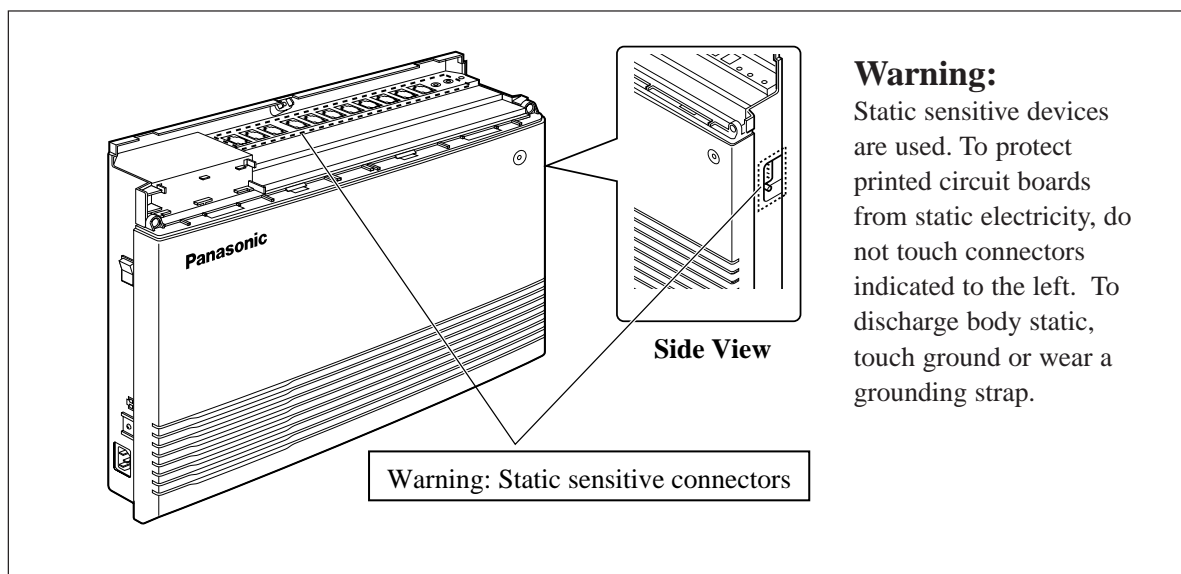

* The illustration on this page is a KX-TA308.

2.2 Unpacking

Unpack the box and check the items below.

Main Unit	1	Music Source Connector	1
AC Cord	1	Plug Adaptor	1
Screws (Wall Mounting)	3	Strap	1
Washers (Wall Mounting)	3	Rivet	1
Pager Connector	1		

2.3 Names and Locations

■ KX-TA308

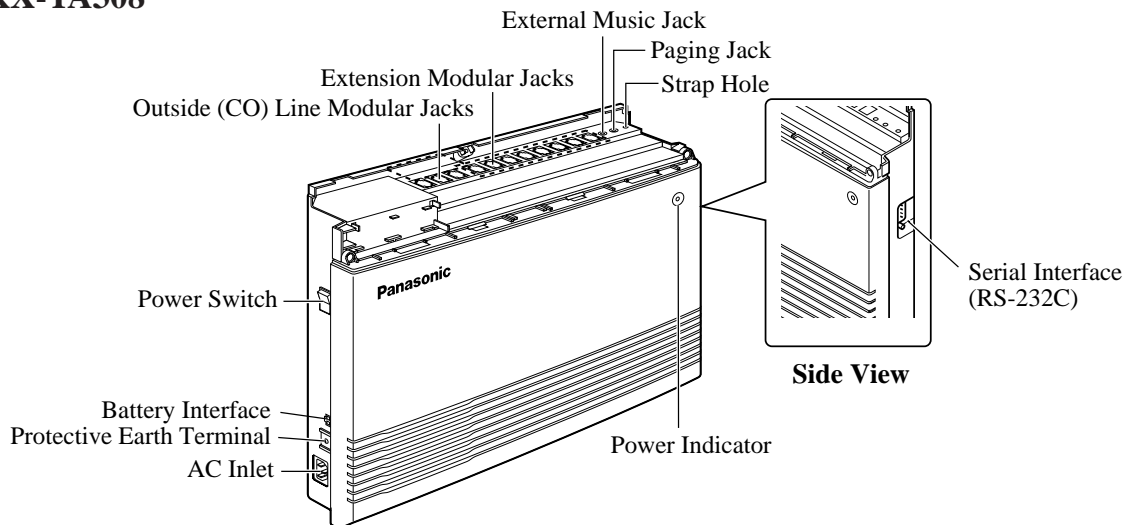

■ KX-TA616

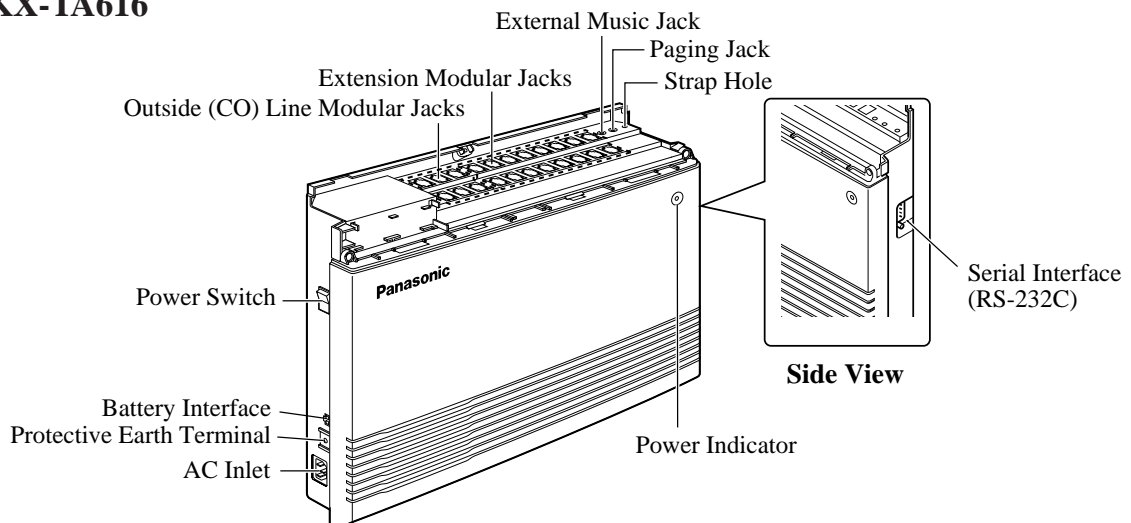

2.4 Wall Mounting

This set is designed for wall mounting only. The wall where the main unit is to be mounted must be able to support the weight of the main unit. If screws other than the ones supplied are used, use screws with the same diameter as the ones enclosed.

Mounting on a Wooden Wall

1. Place the template (on the last page) on the wall to mark the screw positions.

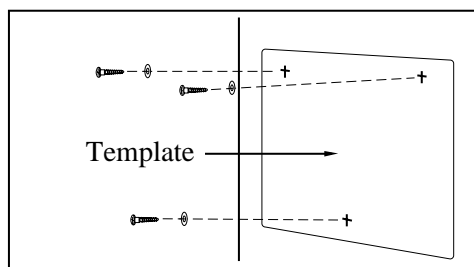

2. Install the screws (included) into the wall.

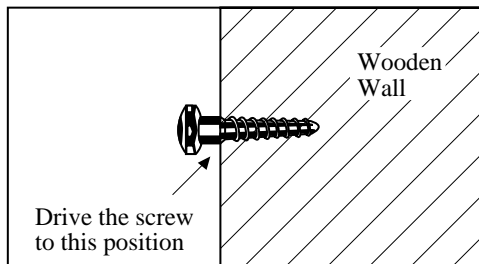

3. Hook the main unit on the screw heads.

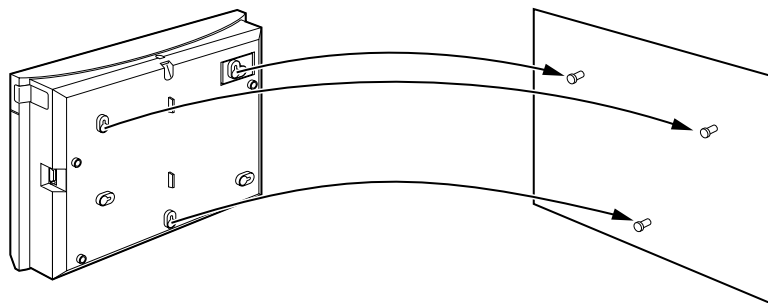

Mounting on a Concrete or Mortar Wall

1. Place the template (on the last page) on the wall to mark the screw positions.
2. Drill holes and drive the anchor plugs (user-supplied) with a hammer, flush to the wall.

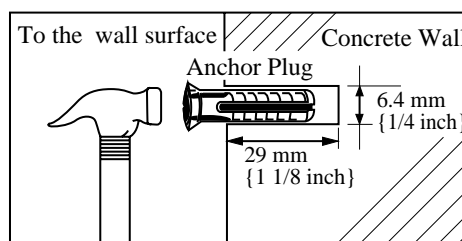

3. Install the screws (included) into the anchor plugs.

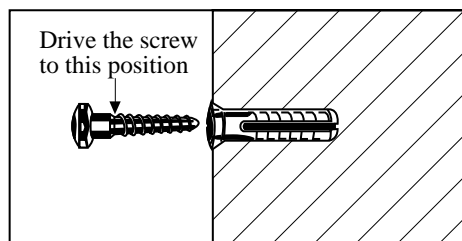

4. Hook the main unit on the screw heads.

2.5 *Frame Ground Connection*

IMPORTANT!!!

Connect the frame of the main unit to the ground.

1. Loosen the screw.
2. Insert the grounding wire (user-supplied).
3. Tighten the screw.
4. Connect the grounding wire to the ground.

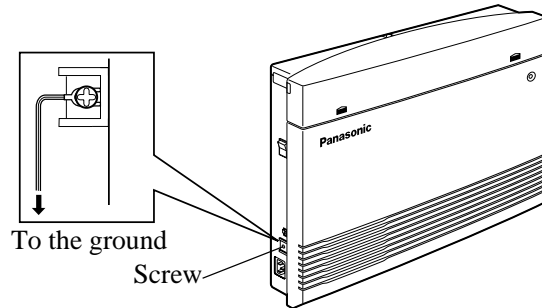

2.6 *Opening the Top Front Cover*

1. Loosen the screw.
2. Remove the top front cover.

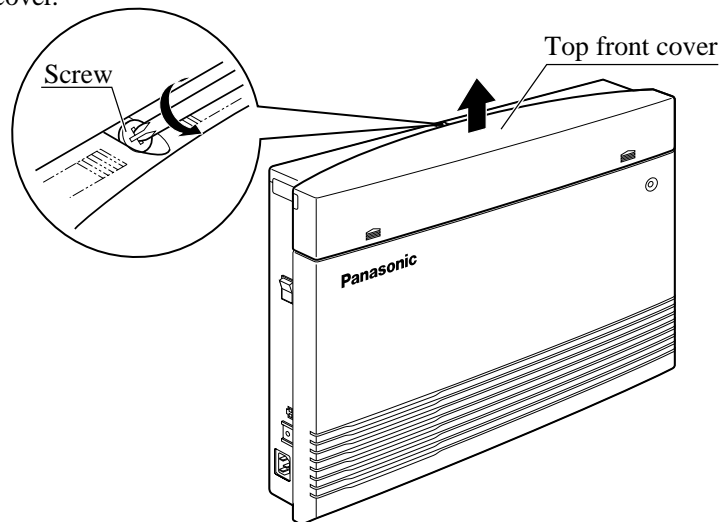

- The screw cannot be removed from the cover.

2.7 *Outside (CO) Line Connection*

Connection

1. Insert the modular plugs of the telephone line cords (2-conductor wiring) into the modular jacks (CO 1 through 3) on the system.
2. Connect the line cords to the terminal board or the modular jacks from the Central Office.

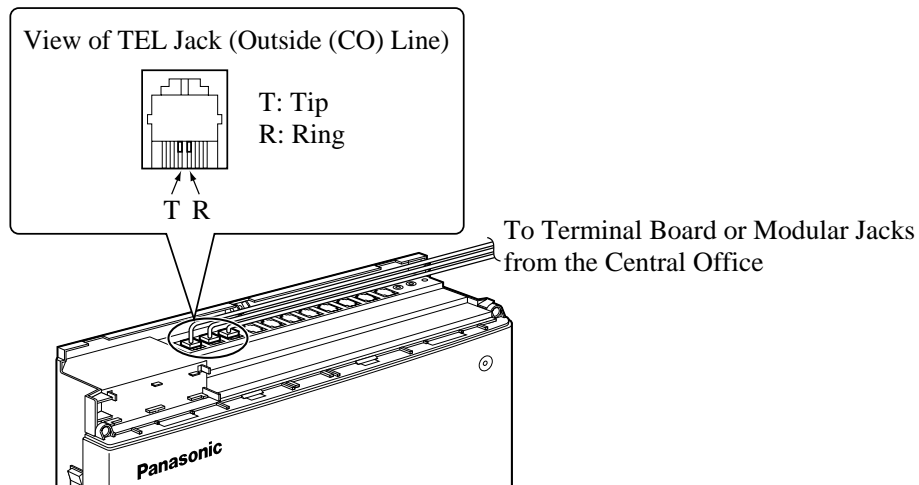

Installing Lightning Protectors

A lightning protector is a device to be installed on an outside (CO) line to prevent a dangerous surge from entering the building and damaging the equipment.

A dangerous surge can occur if a telephone line comes in contact with a power line.

Problems due to lightning surges have been steadily increasing with the development of electronic equipment.

In many countries, there are regulations requiring the installation of a lightning protector.

A lightning strike to a telephone cable which is 10 m {33 feet} above ground can be as high as 200 000 V.

This system should be installed with lightning protectors. In addition, grounding (connection to earth ground) is very important to protect the system (☞ 2.5, Frame Ground Connection).

Recommended lightning protectors

- TELESPIKE BLOK MODEL TSB (TRIPPE MFG. CO.)
- SPIKE BLOK MODEL SK6-0 (TRIPPE MFG. CO.)
- Super MAX™ (PANAMAX)
- MP1 (ITW LINK)

* The illustration on this page is a KX-TA308.

2.7 *Outside (CO) Line Connection*

Installation

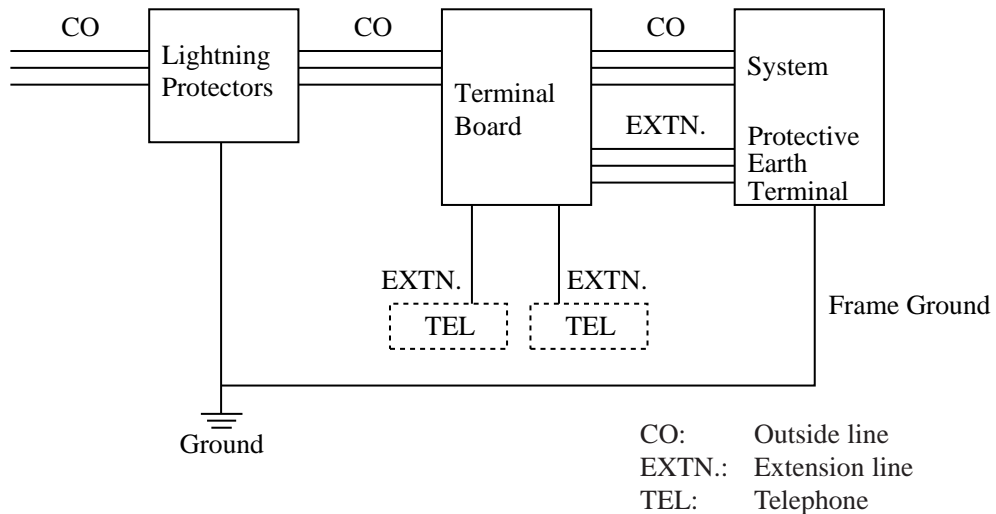

Installation of an Earth Rod

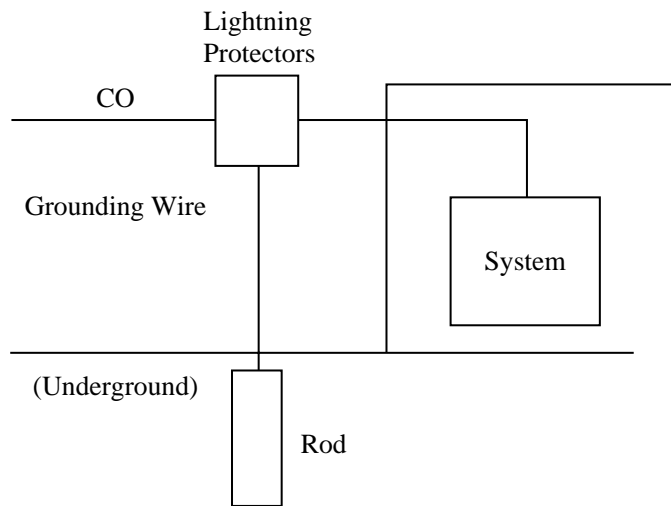

- 1) Installation location of the earth rod Near the protector
- 2) Check obstructions None
- 3) Composition of the earth rod Metal
- 4) Depth of the earth rod More than 50 cm {20 inches}
- 5) Size of the grounding wire Thickness more than 16 AWG

Note • The above example is only a recommendation.
 • The length of the earth rod and required depth depend on the composition of the soil.

2.8 Extension Connection

Extension jacks 01 through 08 for the KX-TA308 and extension jacks 01 through 16 for the KX-TA616 can be used for all kinds of telephones.

Telephone Wiring

The maximum length of the extension line cord (twisted cable) which connects the system and the extension is as follows.

	Diameter of the line	Max. length
Single Line Telephone (Station Loop Limit: 600 Ω including set)	22 AWG	1798 m {5900 feet}
	24 AWG	1128 m {3700 feet}
	26 AWG	698 m {2290 feet}
Proprietary Telephone (Station Loop Limit: 40 Ω)	22 AWG	360 m {1180 feet}
	24 AWG	229 m {750 feet}
	26 AWG	140 m {460 feet}

2 or 4-conductor wiring is required for each extension as listed below. There are 4 pins possible for connection: "T" (Tip), "R" (Ring), "L" (Low) and "H" (High).

Telephone	Wiring
Single line telephones	1 pair wire (T, R)
Proprietary telephone (e.g., KX-T7330)	2 pair wire (L, H, T, R)

- ! If a telephone or answering machine with an A-A1 relay is connected to the system, set the A-A1 relay switch on the telephone or answering machine to the OFF position.

Connection

Insert the modular plugs of the telephone line cords (2 or 4-conductor wiring) into the modular jacks on the system.

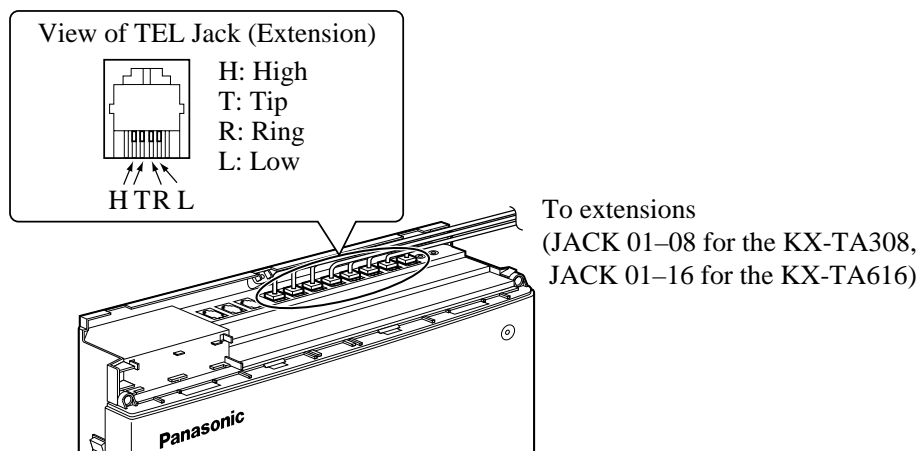

* The illustration on this page is a KX-TA308.

2.9 External Pager (Paging Equipment) Connection

One external pager (user-supplied) can be connected to the system as illustrated below.

Use an EIAJ RC-6701 A plug (2-conductor, ϕ 3.5 mm in diameter).

- Output impedance: 600 Ω

Maximum length of the cable

AWG 18 – 22: Under 10 m {33 feet}

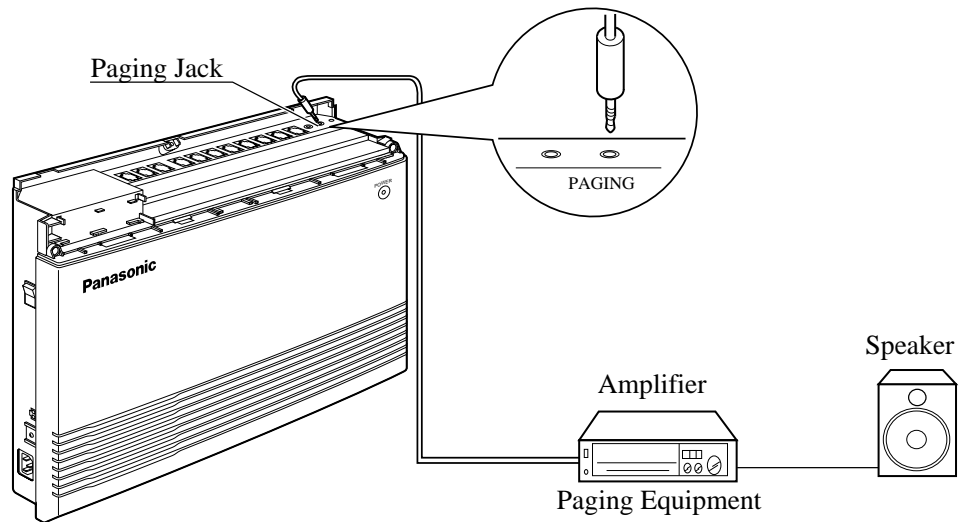

- ! • To adjust the sound level of the pager, use the volume control on the amplifier.
- ☞ • **Required System Programming**
Section 4.2, System Programming
[106] External Paging Access Tone
- **Feature Reference**
Section 3, Features
Paging

* The illustration on this page is a KX-TA308.

2.10 External Music Connection

One music source, such as a radio (user-supplied), can be connected to the system as illustrated below.

Insert the plug to the earphone/headphone jack on the external music source.

Use an EIAJ RC-6701 A plug (2-conductor, ϕ 3.5mm in diameter).

- Input impedance: 8 Ω

Maximum length of the cable

AWG 18 – 22: Under 10 m {33 feet}

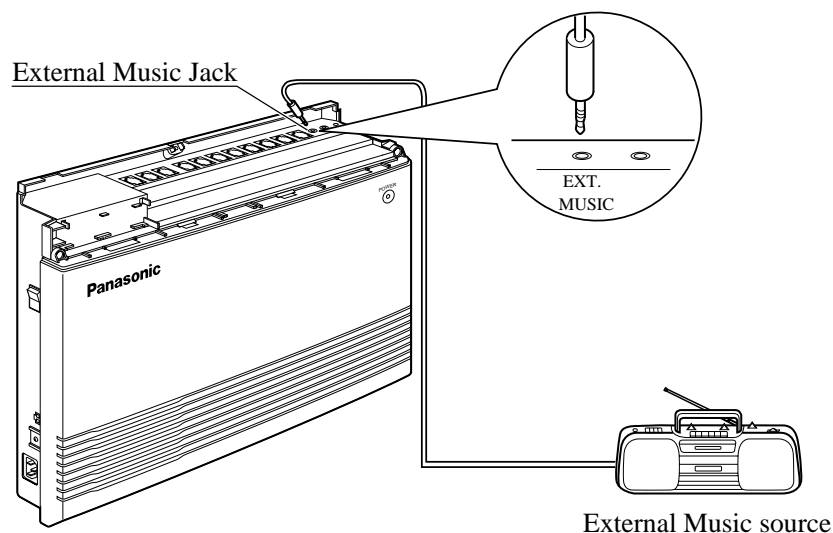

- System programming for the music sources used for Music on Hold and Background Music (BGM) is required.
- To adjust the sound level of the Music on Hold, use the volume control on the external music source.



- **Required System Programming**
Section 4.2, System Programming
[111] Hold Music Selection
- **Feature Reference**
Section 3, Features
Music on Hold / Background Music (BGM)

* The illustration on this page is a KX-TA308.

2.11 Paralleled Telephone Connection

Any single line telephone can be connected in parallel with a proprietary telephone as follows.

Using a Modular T-Adaptor

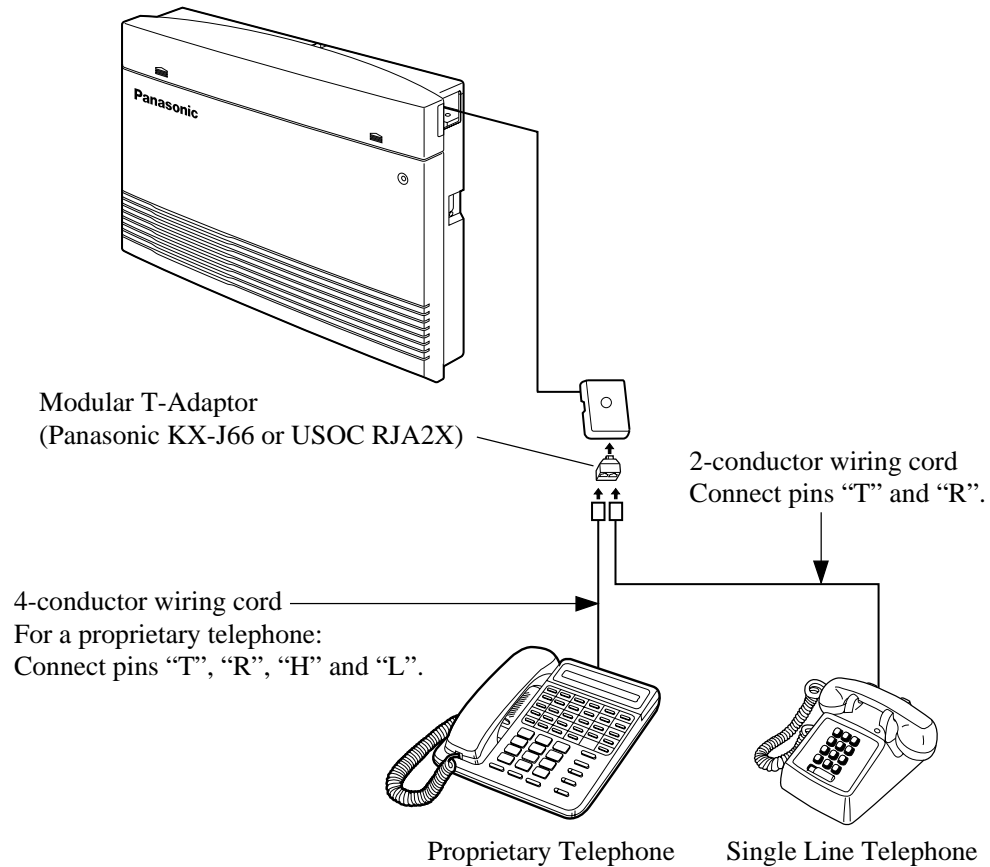

- **Required System Programming**
Section 4.2, System Programming
[610] Paralleled Telephone Connection
- **Feature Reference**
Section 3, Features
Paralleled Telephone Connection

2.12 Polarity Sensitive Telephone Connection

If your telephone is polarity sensitive, follow the procedure below:

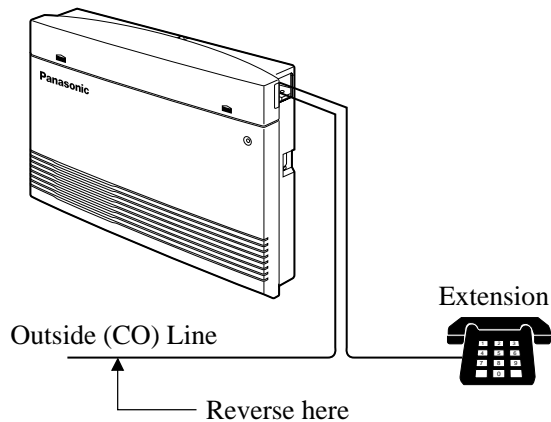
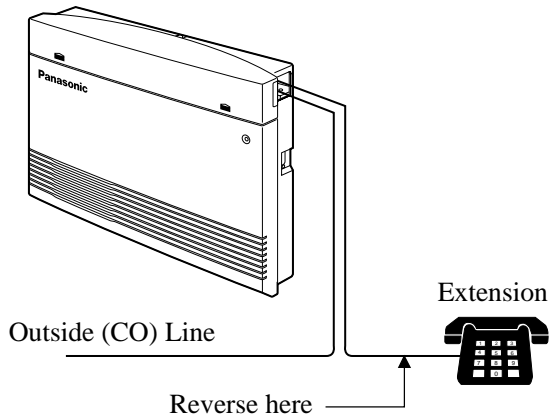

1. Complete all the required extension wiring.
2. Confirm that dialing can be done from all the extensions using a touch-tone telephone.
If dialing fails, the polarity between the extension and the system must be reversed.
3. Reverse as shown.
4. Unplug the system.
5. Connect all outside lines.
6. Confirm that dialing can be done on the following extension using a touch-tone telephone.
Extension (T, R) of jack 01: Outside (CO) line 1
If dialing fails, the polarity between the system and the outside line must be reversed.
7. Reverse as shown.
8. Every time an extension telephone is replaced, repeat the procedure above.

2.13 *Printer and PC Connection*

A user-supplied printer or personal computer (PC) can be connected to the system. These are used to print out or refer to the SMDR call records and system programming data. Connect the printer cable or the PC cable to the Serial Interface (RS-232C) connector. The cable must be shielded and the maximum length is 2 m {6.5 feet}.

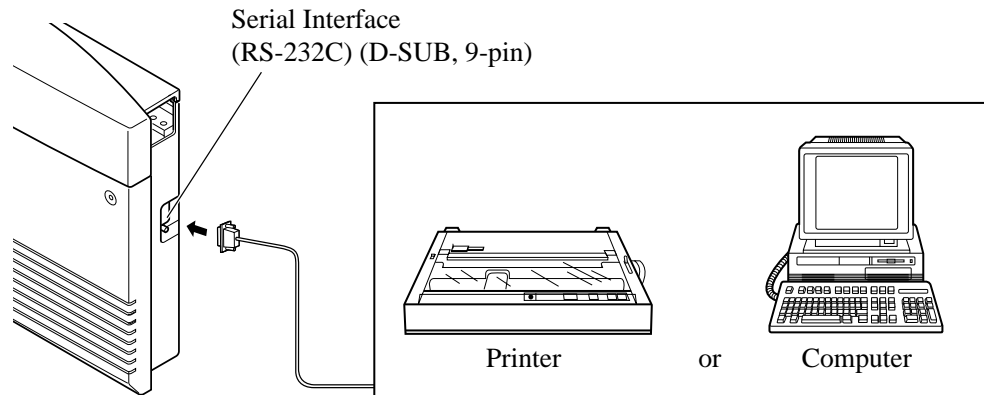

Arrange the cables so that the printer will be connected to the system as shown in the appropriate chart on the following page.

The pin configuration of the Serial Interface (RS-232C) Connector is as follows.

Pin No.	Signal Name		Circuit Type	
			EIA	CCITT
2	RXD	Received Data	BB	104
3	TXD	Transmitted Data	BA	103
4	DTR	Data Terminal Ready	CD	108.2
5	SG	Signal Ground	AB	102
6	DSR	Data Set Ready	CC	107
7	RTS	Request To Send	CA	105
8	CTS	Clear To Send	CB	106

2.13 Printer and PC Connection

Connection Chart for a Printer / Personal Computer with the System

If you connect a printer or a PC with a 9-pin cable, follow the chart below.

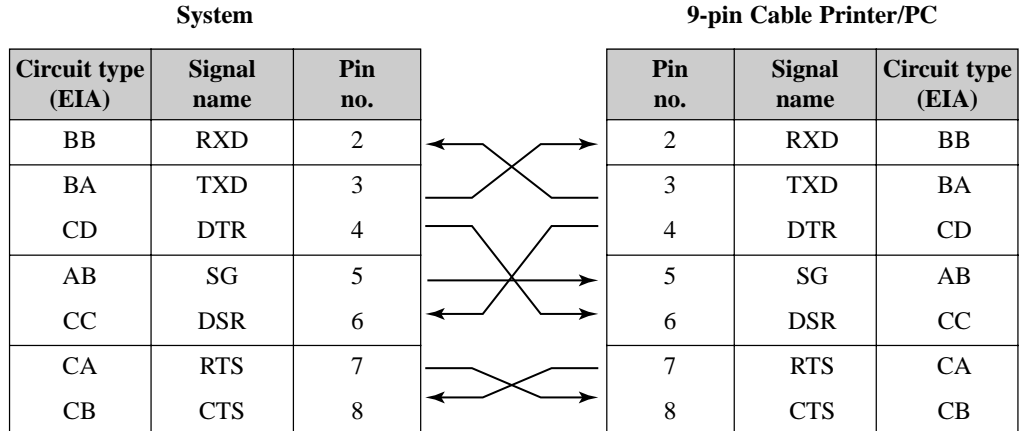

If you connect a printer or a PC with a 25-pin cable, follow the chart below.

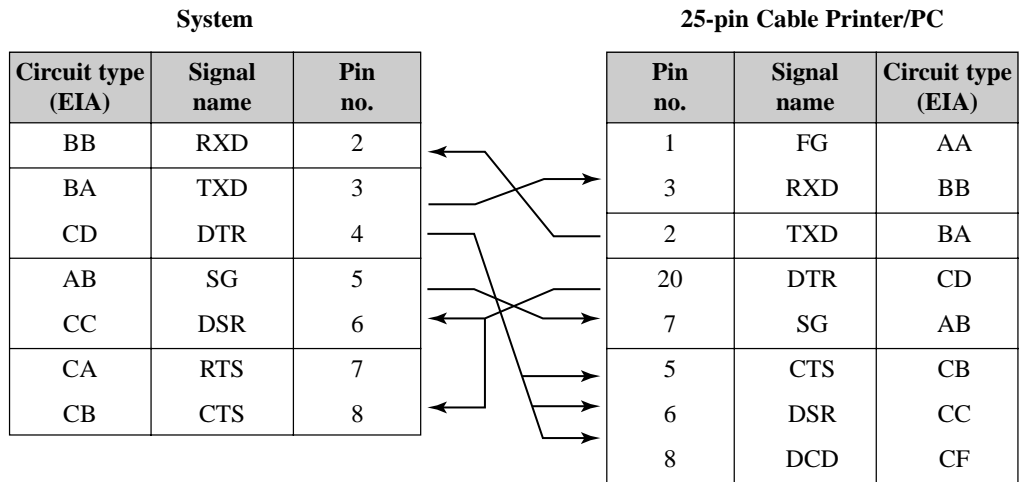

2.13 *Printer and PC Connection*

Serial Interface (RS-232C) Signals

Frame Ground: FG

Connects the unit frame and the earth ground conductor of the AC power cord.

Transmitted Data: SD (TXD) (output)

Conveys signals from the unit to the printer. A “Mark” condition is held unless data or BREAK signals are being transmitted.

Received Data: RD (RXD) (input)

Conveys signals from the printer.

Request to Send: RS (RTS) (output)

This lead remains ON whenever DR (DSR) is ON.

Clear To Send: CS (CTS) (input)

When the CS (CTS) circuit is ON, it indicates that the printer is ready to receive data from the unit. The unit does not attempt to transfer data or receive data when the CS (CTS) circuit is OFF.

Data Set Ready: DR (DSR) (input)

When the DR (DSR) circuit is ON, it indicates the printer is ready. The DR (DSR) circuit being ON does not indicate that communication has been established with the printer.

Signal Ground: SG

Connects the DC ground of the unit for all interface signals.

Data Terminal Ready: ER (DTR) (output)

This signal line is turned ON by the unit to indicate that it is ON LINE. The ER (DTR) circuit being ON does not indicate that communication has been established with the printer. It is switched OFF when the unit is OFF LINE.

Data Carrier Detect: CD (DCD) (input)

When ON, it indicates the data terminal (DTE) that the carrier signal is being received.



- **Required System Programming**

- Section 4.2, System Programming

- [800] SMDR RS-232C Communication Parameters

- [801] SMDR Parameter

- **Feature Reference**

- Section 3, Features

- Station Message Detail Recording (SMDR)

2.14 Location of Optional Cards

The location of the optional cards is shown below.

Precaution To protect the printed circuit boards (P-boards) from static electricity, do not touch parts on the P-boards in the main unit and on the optional cards. If accessing the parts is required, wear a grounding strap.

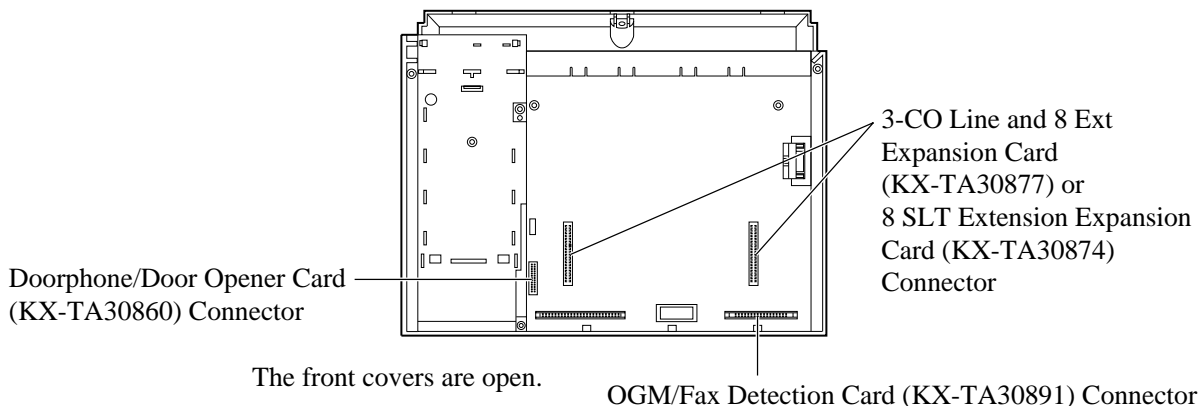

NOTE:

Power off the system, and unplug the AC cord before installing an optional card.

2.15 OGM/FAX Detection Card Installation

An optional OGM/FAX Detection Card (KX-TA30891) can be installed to the system.

The OGM/FAX Detection Card supports the following.

Direct Inward System Access (DISA) with OGM:

One of the system features. An outgoing message greets the external caller and gives information so that the caller can access an extension(s) directly.

Facsimile detection:

When the system receives a facsimile transmission signal by DISA, it automatically connects the specified facsimile extension.

1. Remove the 2 screws.

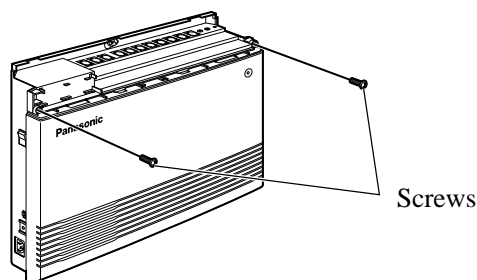

* The illustrations on this page are a KX-TA308.

2.15 OGM/FAX Detection Card Installation

2. Open the bottom front cover.

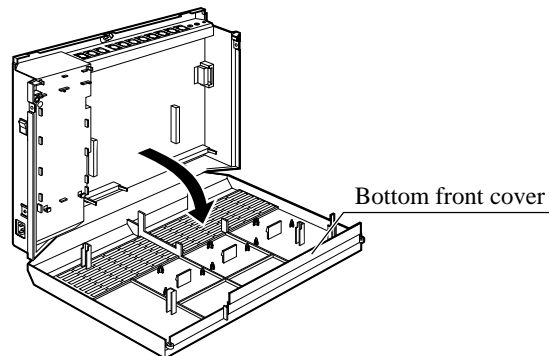

3. Attach the OGM/FAX Detection card.

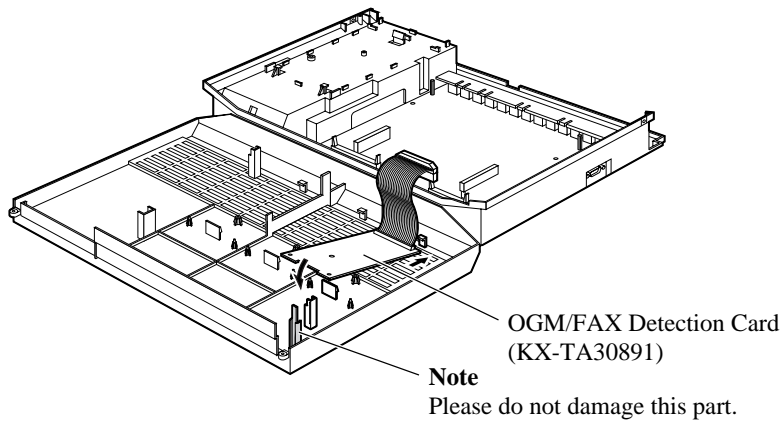

4. Insert the flat cables to the card connector.

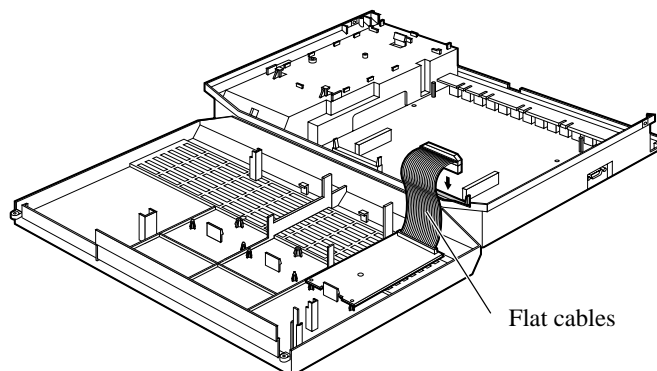

5. Close the cover.



- **Required System Programming**

- See 'Required System Programming' in Section 3, Features "Direct Inward System Access (DISA)"

- **Feature References**

- Section 3, Features**

- Direct Inward System Access (DISA)

- Outgoing Message (OGM)

* The illustrations on this page are a KX-TA308.

2.16 Doorphone and Door Opener Connection

Four doorphones (KX-T30865) and 4 door openers (user-supplied) can be installed.

Maximum cable length

The maximum length of the doorphone and door opener line cord which connects the system is as follows.

	Diameter of the line	Max. length
Doorphone	22 AWG	180 m {590 feet}
(Station Loop Limit: 20 Ω)	24 AWG	113 m {370 feet}
	26 AWG	70 m {230 feet}
Door Opener	22 AWG	180 m {590 feet}

Installing the Doorphone

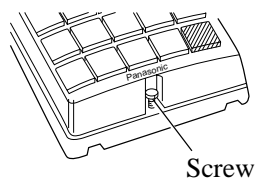

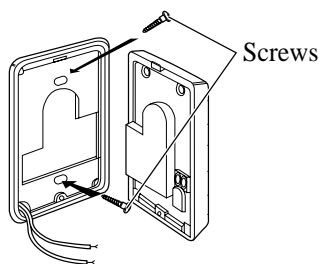

1. Loosen the screw to open the doorphone unit.



2. Attach the base cover to a wall using 2 screws.

Note Two kinds of screws are included. Please choose the appropriate one depending on your type of wall.

 Type 1: When a doorphone plate has been fixed to the wall.

 Type 2: When you wish to install the doorphone directly to the wall.

3. Connect the wires to the screws located in the front cover.

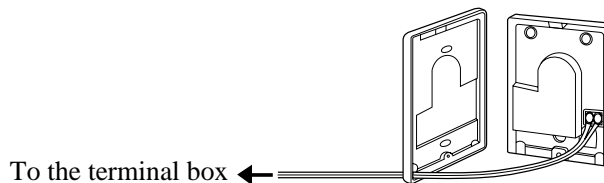

4. Put the doorphone together and re-install the screw.

2.16 Doorphone and Door Opener Connection

Doorphone/Door Opener Installation

Attach the optional Doorphone/Door Opener Card to the main unit, connect the cord to the Doorphone/Door Opener Card connector and secure the screw.

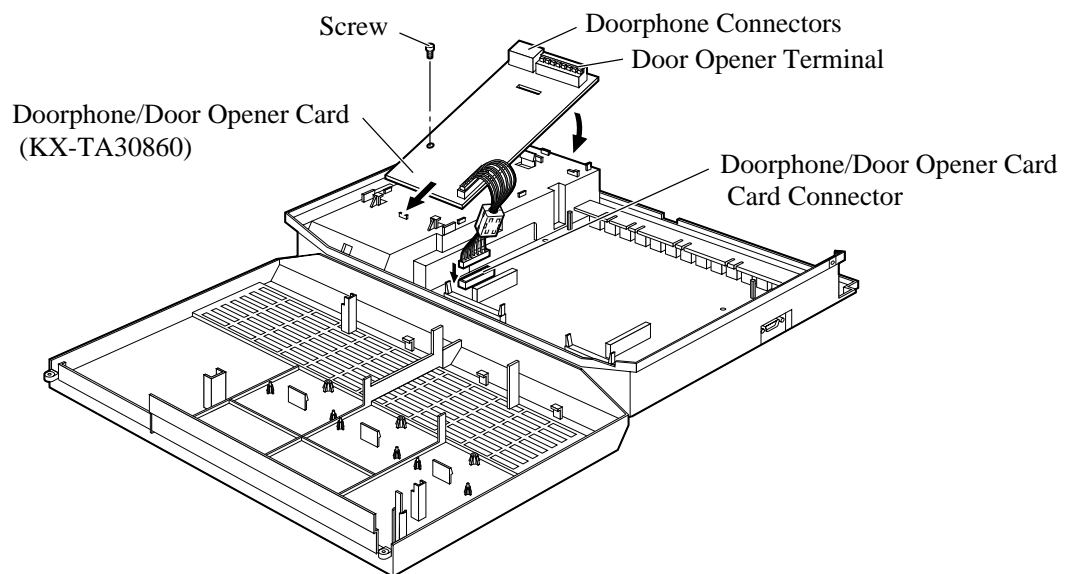

* The illustration on this page is a KX-TA308.

2.16 Doorphone and Door Opener Connection

Wiring of the Doorphone

1. Connect the Doorphone/Door Opener Card to the terminal boxes using 4-conductor modular connectors.
2. Connect the wires of doorphones 1 and 3 to the red and green screws on the terminal box.
3. Connect the wires of doorphones 2 and 4 to the yellow and black screws on the terminal box.

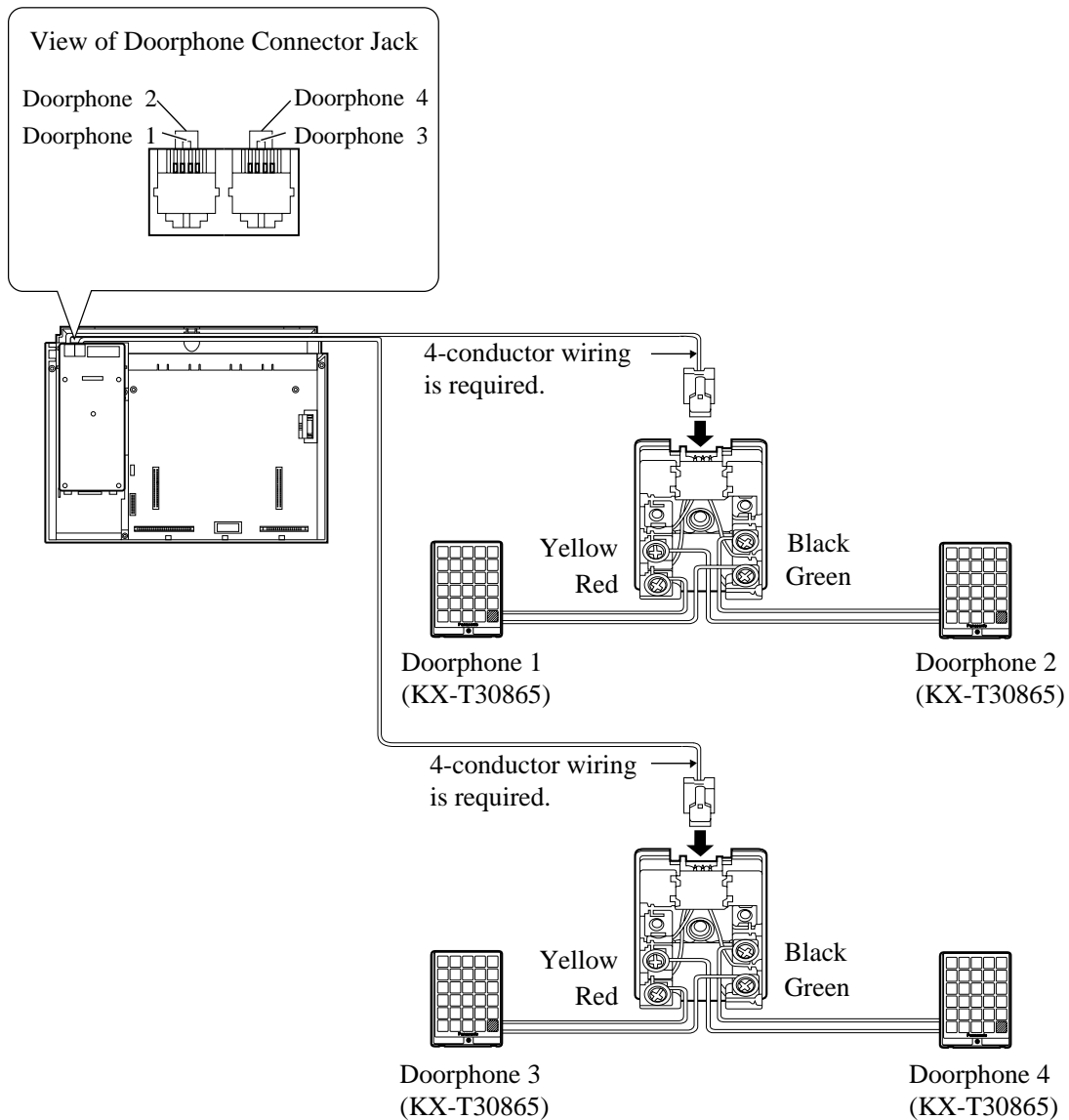

* The illustration on this page is a KX-TA308.

2.16 Doorphone and Door Opener Connection

Connecting Door Openers

1. While pressing the button below a hole with a driver, insert the wire from the door opener into the hole.

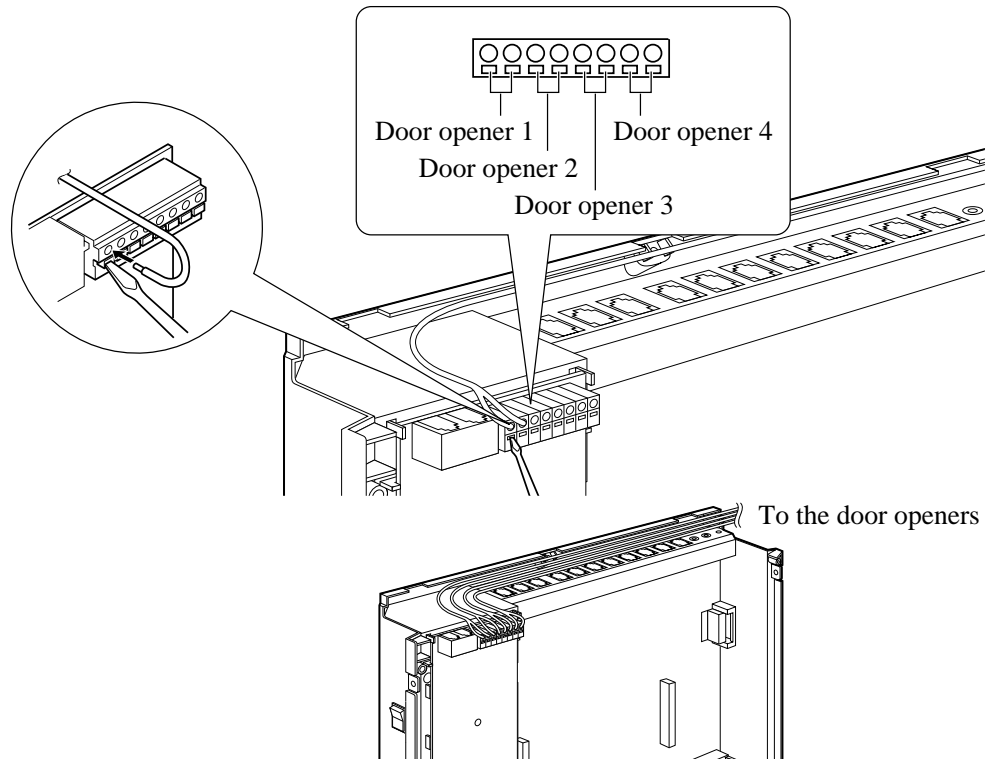

2. Wrap the strap around all of the cords. (→ 2.20, Securing the Cords)



- We recommend using UL1015 wire or the equivalent for wiring.
- The wire should be between 0.4 mm and 1.2 mm {1/64 inch – 3/64 inch} in diameter including the coating.

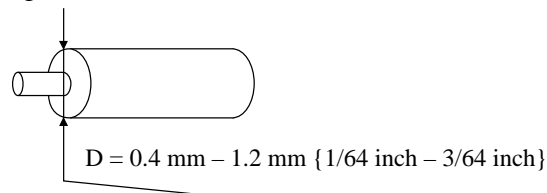

- **Required System Programming**
Section 4 System Programming
[700]–[702] Doorphone Ringing Assignment — Day/Night/Lunch
[703]–[705] Door Opener Assignment — Day/Night/Lunch
- **Feature References**
Section 3, Features
Door Opener, Doorphone Call

* The illustrations on this page are a KX-TA308.

2.17 Backup Batteries Connection

Two car batteries can be connected to the system as a backup power supply in the event of a power failure.

1. Attach the cables (KX-A227) and 2 user-supplied car batteries (12 V DC each) as shown below. Then insert the connector into the side of the system.

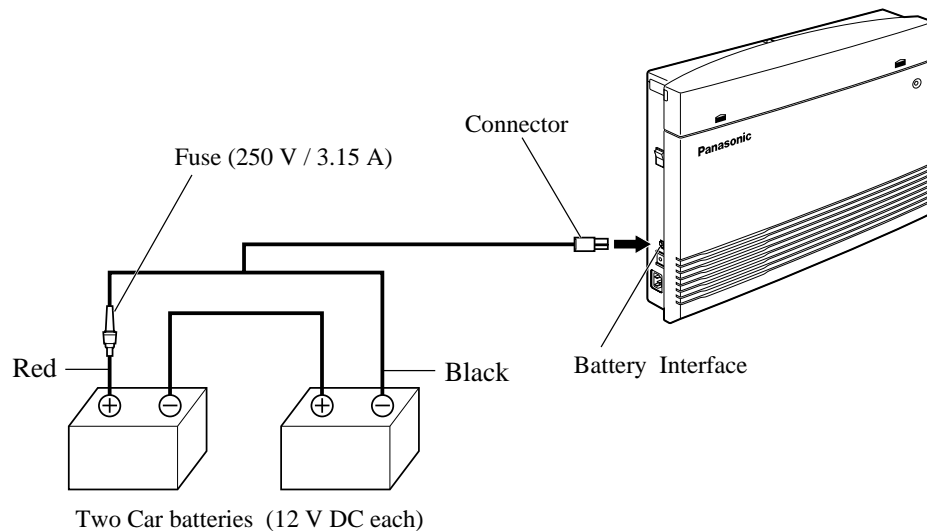

- ! • Make sure of the polarities of batteries and wire.
- Make sure that you do not short the batteries and wires.

2.18 *Installing a 3-CO Line & 8 Ext Expansion Card (KX-TA30877) and 8 SLT Extn. Expansion Card (KX-TA30874)*

3-CO Line and 8 Ext Expansion Card Installation (KX-TA30877) — for KX-TA308 only

To add 3 outside (CO) lines (outside (CO) lines 4 through 6) and 8 extensions (extension jacks 09 through 16), use an optional 3-CO Line and 8 Ext Expansion Card (KX-TA30877).

8 SLT Extension Expansion Card Installation (KX-TA30874)

To add 8 extensions (extension jacks 17 through 24), use an optional 8 SLT Extension Expansion Card (KX-TA30874).

This card can be installed directly to the system or to the KX-TA30877.



- Only a single line telephone (SLT) can be connected to extension jacks 17 through 24.

Installing the KX-TA30877 to the KX-TA308

1. Loosen the screws and open the top and bottom front covers.
2. Remove the lower front panel with pliers as shown below. Cut the 6 areas marked with a circle.

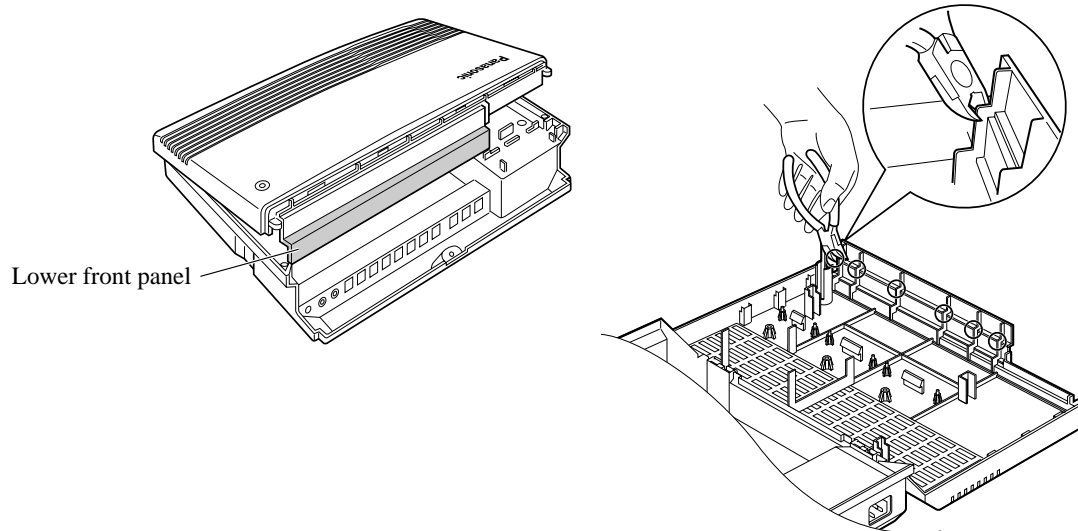

2.18 *Installing a 3-CO Line & 8 Ext Expansion Card (KX-TA30877) and 8 SLT Extn. Expansion Card (KX-TA30874)*

3. After cutting the areas, be sure to cut off any excess plastic in order to make the surface smooth.

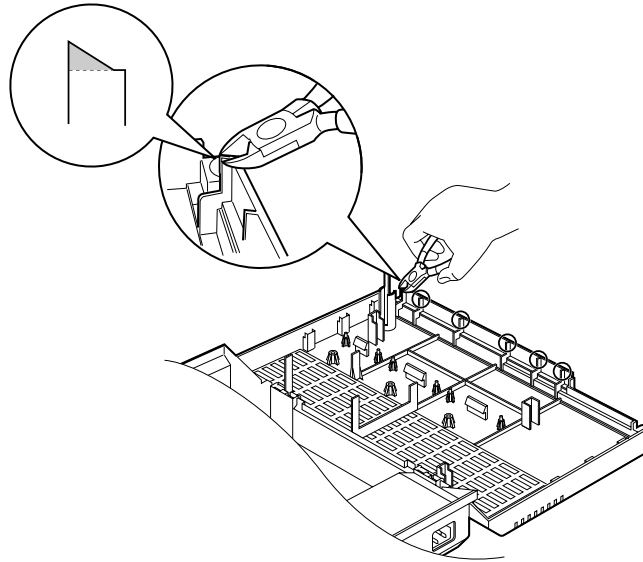

4. First, insert the plastic spacer into the hole on the KX-TA30877. Attach the 2 extension connectors to the system, install the KX-TA30877 and secure the 2 extension bolts.

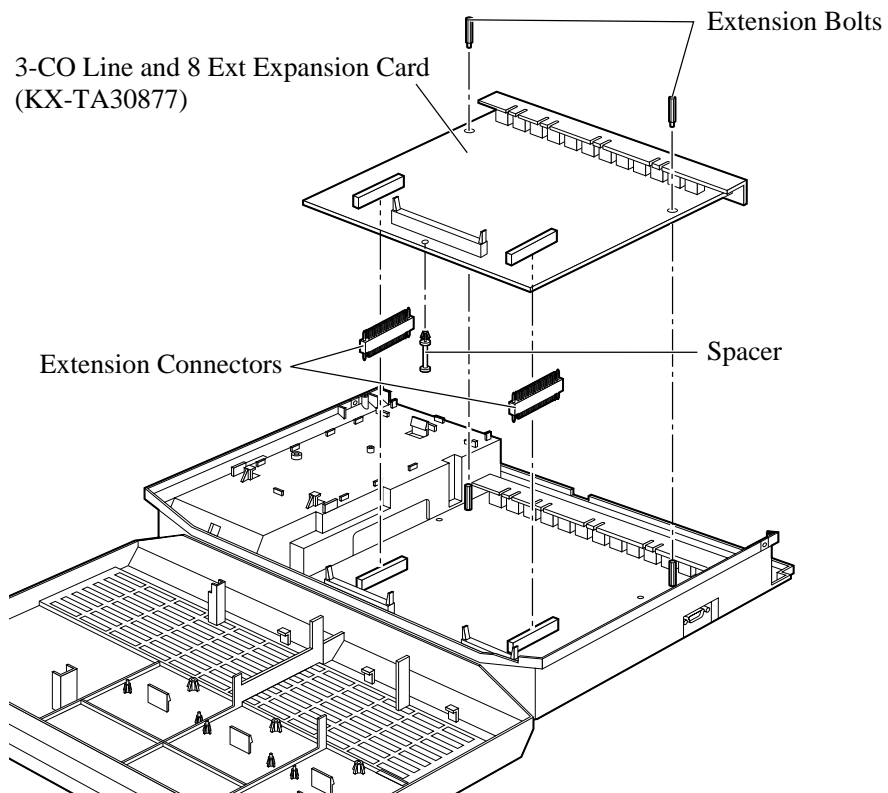

2.18 *Installing a 3-CO Line & 8 Ext Expansion Card (KX-TA30877) and 8 SLT Extn. Expansion Card (KX-TA30874)*

5. Insert the modular plugs of the telephone line cords (2-conductor wiring) into the modular jacks (CO 4 through 6) on the card. (☞ 2.7, Outside (CO) Line Connection)
6. Connect the line cords to the terminal board or the modular jacks from the Central Office.
7. Insert the modular plugs of the telephone line cords (2 or 4-conductor wiring) into the modular jacks (JACK 09 through 16). (☞ 2.8, Extension Connection)
8. Wrap the strap around all of the cords. (☞ 2.20, Securing the Cords)
9. Close the covers and secure the screws.

Installing the KX-TA30874

1. Loosen the screws and open the front and bottom front covers.
2. If your system is a KX-TA308, remove the lower front panel in the same way as installing a KX-TA30877. If you install the KX-TA30874 to a KX-TA616 or a KX-TA30877, which is connected to a KX-TA308, remove the top front panel with pliers.

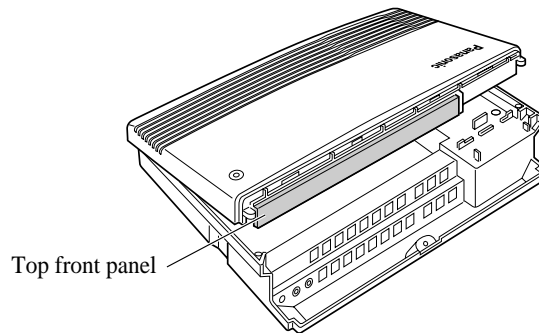

3. After cutting the areas, be sure to cut off any excess plastic in order to make the surface smooth. Please refer to installing the KX-TA30877.

2.18 *Installing a 3-CO Line & 8 Ext Expansion Card (KX-TA30877) and 8 SLT Extn. Expansion Card (KX-TA30874)*

4. Attach the 2 extension connectors to the system first, install the KX-TA30874 and secure the 2 screws.

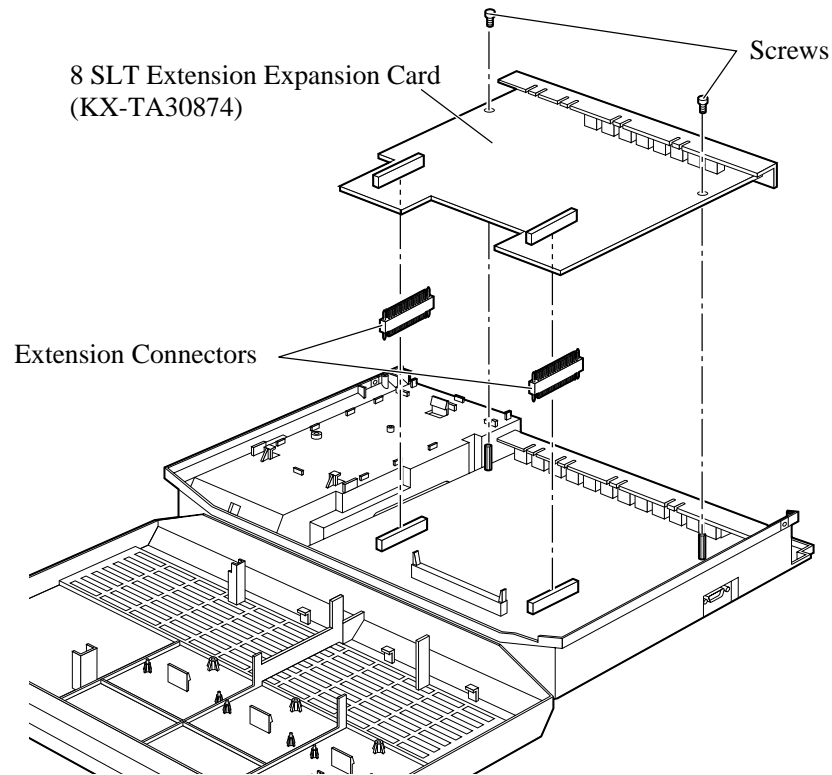

5. Insert the modular plugs of the telephone line cords (2-conductor wiring) into the modular jacks (JACK 17 through 24). (☞ 2.8, Extension Connection)
6. Wrap the strap around all of the cords. (☞ 2.20, Securing the Cords)
7. Close the covers and secure the screws.

* The illustration on this page is a KX-TA308.

2.18 *Installing a 3-CO Line & 8 Ext Expansion Card (KX-TA30877) and 8 SLT Extn. Expansion Card (KX-TA30874)*

Installing the KX-TA30877 and KX-T30874 — for KX-TA308 only

1. Install the KX-TA30877 first and then the KX-TA30874.

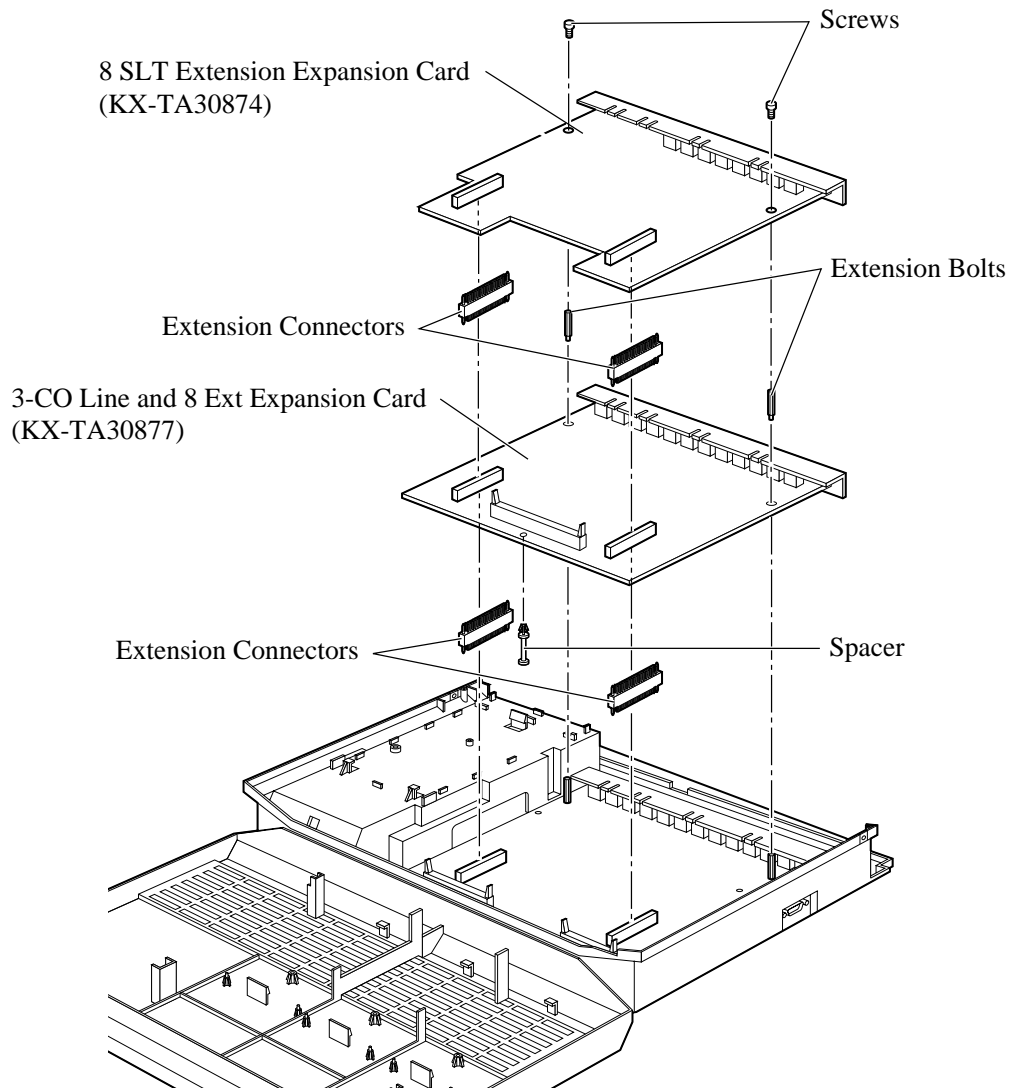

2.19 *Auxiliary Connection for Power Failure Transfer*

Power failure transfer connects a specific single line telephone (SLT) to selected outside (CO) lines in the event of system power failure, as follows.

Outside (CO) line 1 – extension (T, R) jack 01

Outside (CO) line 4 – extension (T, R) jack 09

Connection of outside (CO) lines 1 and 4, and the respective extensions require no auxiliary connection.



- In the event of a power failure, system memory is protected by a factory-provided lithium battery. There is no memory loss except the Camp-on, Saved Number Redial, Last Number Redial, Call Park and Message Waiting memories.
- The system automatically changes the current connection to the above connection when the power supply stops.
- Proprietary telephones cannot be used during a power failure. Therefore, we recommend connecting SLTs in parallel with proprietary telephones connected to extension jacks 01 and 09, or connecting a KX-T7033 (power failure telephone).
- If DC power is available from backup batteries when AC power fails, the system will not change the current connection to the above connection. (☞ 2.17, Backup Batteries Connection)



- **Feature References**
Section 3, Features
Power Failure Transfer, Paralleled Telephone Connection

2.20 *Securing the Cords*

1. Insert the rivet into the hole in the strap.
2. Insert the rivet and strap into the hole on the system.

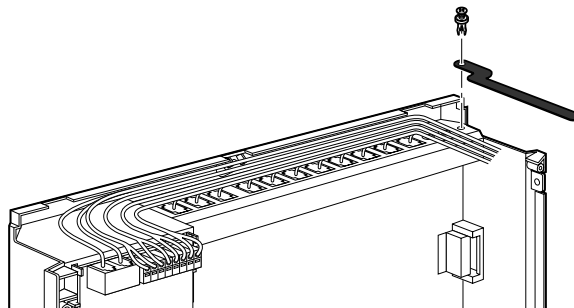

* The illustration on this page is a KX-TA308.

2.20 *Securing the Cords*

3. Wrap the strap around all of the cords.

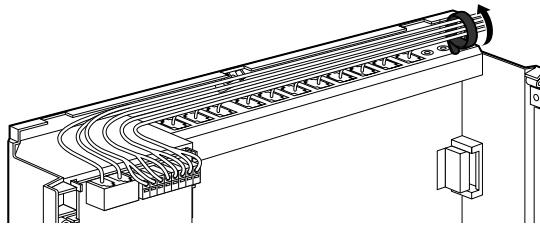

4. To remove the rivet, use a screw driver as shown below.

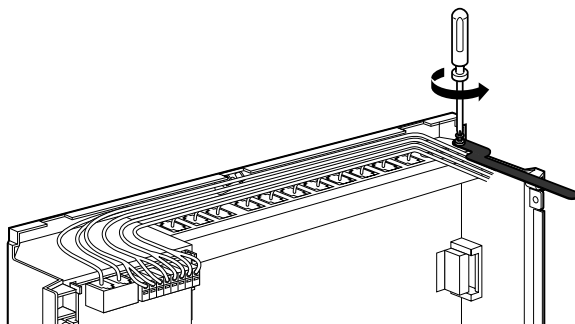

2.21 *Closing the Front Cover*

1. Replace the covers and tighten the screws.
2. Tie together all of the connected cords and attach them to the wall so that the cords cannot be pulled out of the system.

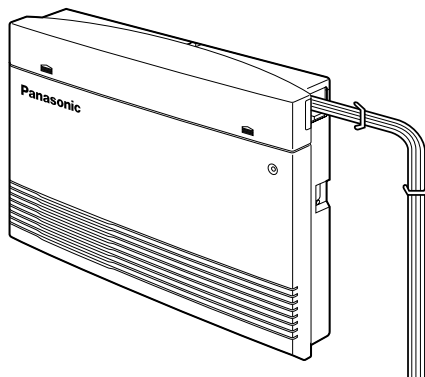

* The illustrations on this page are a KX-TA308.

2.22 Starting the System for the First Time

1. Set the Power Switch to the “OFF” position.
2. Plug the AC power cord into the system and an AC outlet.
3. Turn the Power Switch on.
(The power indicator will light.)
4. Perform the following operation with a proprietary telephone connected to JACK 01.
 - a) Press the PROGRAM button, or set the MEMORY switch to “PROGRAM” on the back of the telephone.
 - b) Press * #.
 - c) Enter 1234.
 - d) Enter 999.
 - e) Press the NEXT (SP-PHONE) button.
 - f) Press the SELECT (AUTO ANS/MUTE or AUTO ANSWER/MUTE) button until “All Para” is displayed.
 - g) Press the STORE (AUTO/STORE or AUTO DIAL/STORE) button.
 - h) Press the END (HOLD) button.
 - i) Press the PROGRAM button, or set the MEMORY switch to “SET” on the back of the telephone.

The system will be initialized with the default values. If the system does not work properly, please see 2.24, “System Data Clear”.

- CAUTION**
- The system will continue to be powered even if the Power Switch is turned “OFF”.
 - The power supply cord is used as the main disconnect device. Ensure that the outlet is located/installed near the equipment and is easily accessible.

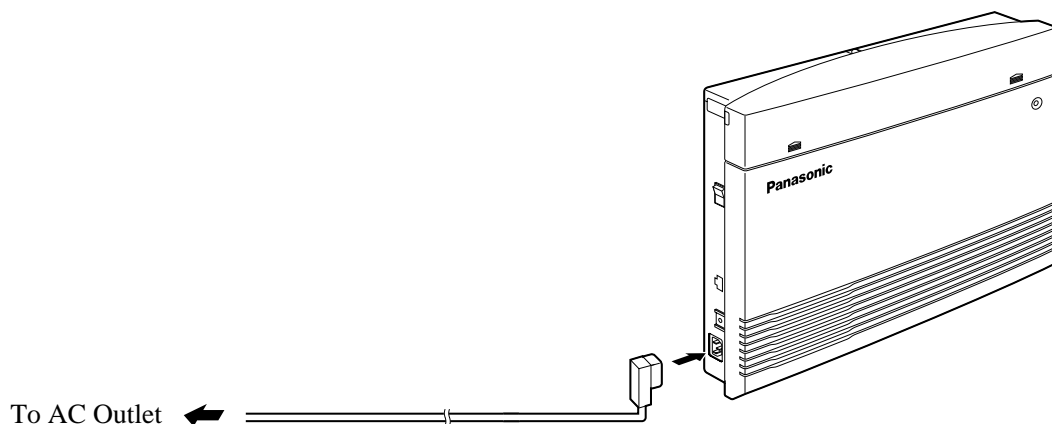

2.22 *Starting the System for the First Time*

Plug Adaptor

The plug adaptor (included) is to be used if the power plug will not fit your socket. Assemble as shown below, using the plug which fits your socket. In this case, be sure to connect the frame of the main unit to ground because the ground line in the power cable cannot be used.

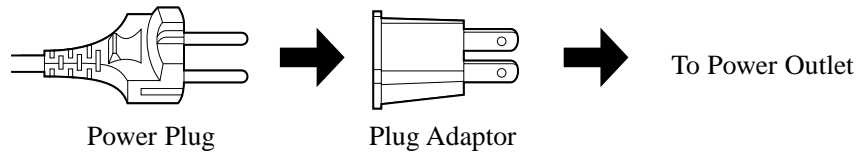

2.23 *System Restart*

After starting the system, if the system does not operate properly, restart the system.

Before restarting the system, try the system feature again to confirm whether there definitely is a problem or not.

System Restart causes the following.

- Camp-on is cleared.
- Calls on Hold are terminated.
- Calls on Exclusive Hold are terminated.
- Calls in progress are terminated.
- Call Park is cleared.
- Message Waiting is cleared.
- Last Number Redial is cleared.
- Saved Number Redial is cleared.

Other data is not cleared by System Restart.

1. Turn the Power Switch “OFF” and then “ON”.



- If the system still does not operate properly, please see 2.24, “System Data Clear”.

2.24 System Data Clear

When the system does not operate properly after restarting, you can clear the programming data stored in the system. The system will restart with the default settings.

First, try system program [999] “System Data Clear” by following step 4 in 2.22, “Starting the System for the First Time”. If the system still does not operate properly, please follow the procedure below.

1. Slide the System Clear Switch to the “CLEAR” position.
2. Press the Reset Button.
3. Return the System Clear Switch to the “NORMAL” position before the power indicator stops flashing.
(The power indicator will flash for about 10 seconds.)

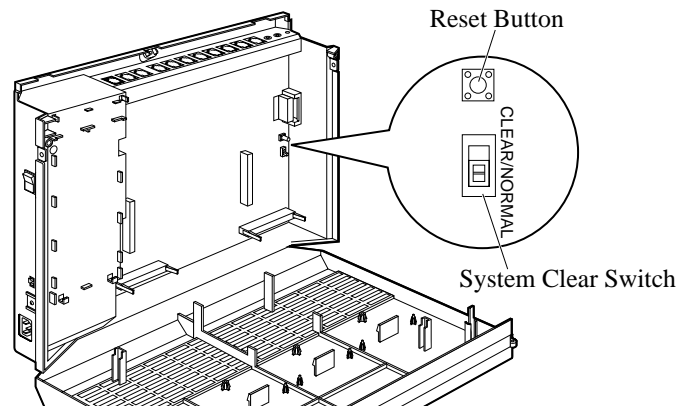

CAUTION • Before touching the System Clear Switch and Reset Button, put on a grounding strap.



- After pressing the Reset Button, return the System Clear Switch to the “NORMAL” position in step 3 before the power indicator stops flashing. Otherwise, the system will not clear.



- **Feature Reference**
Section 3, Features
System Data Default Set

* The illustration on this page is a KX-TA308.

Section 3

Features

Absent Message Capability

Allows an extension user to set a message which will be displayed at the calling extension to show the reason for the called extension's absence. One of 6 messages can be programmed as desired, which are available for any telephone (single line telephone or proprietary telephone). Setting or canceling a message can be done by individual extension users but only callers using a proprietary telephone with a LCD can see the message.



- The 6 messages are shown below. “%” means a parameter to be entered when assigning a message at an extension.
 - (1) Will Return Soon
 - (2) Gone Home
 - (3) At Ext %%% (extension number)
 - (4) Back at %% : %% AM (or PM) (hour : minute)
 - (5) Out Until %%/%% (month / day)
 - (6) In a Meeting
- An extension user can only select one message at a time. The selected message is displayed every time the user goes off-hook.



- **Operating Instructions Reference**
1.6 Before Leaving Your Desk, “Showing Your Message on the Calling Party's Display (Absent Message Capability)”

Account Code Entry

An account code is used to identify incoming and outgoing outside calls for accounting and billing purposes. The account code is appended to the SMDR call record. For incoming outside calls, an account code is optional. For outgoing outside calls, there are 4 account input modes programmable in program [605], Option, Forced, Verify-All and Verify-Toll.

- Option:** A 4-digit code may be entered during a conversation or within 30 seconds after a conversation when a record is needed.
- Forced:** A 4-digit code must be entered within 5 seconds after an outside (CO) line is seized. The code can be any number.
- Verify-All:** Enables to make an outside call if the code entered within 5 seconds after an extension user seizes an outside (CO) line is the same as one of the account codes programmed in [310].
- Verify-Toll:** Enables to override toll restriction temporarily by entering one of the account codes programmed in [310] within 5 seconds after an outside (CO) line is seized. Calls with COS numbers 3 through 5 will be treated as calls with COS number 2. Calls with COS numbers 1 and 2 will not be affected.



- **Required System Programming**

- [310] Account Codes
- [601]-[603] TRS – Class of Service Assignment — Day/Night/Lunch
- [605] Account Code Entry Mode
- [805] SMDR Account Code Selection

- **Related Feature References**

- Station Message Detail Recording (SMDR),
Toll Restriction Override by Account Codes

- **Operating Instructions Reference**

- 1.7 Useful Features, “Calling with Account Codes (Account Code Entry)”

Alternate Calling – Ring/Voice

This system offers a proprietary telephone user 2 types of intercom calling, Voice Call mode and Tone (ring) Call mode. “Voice Call” informs the called party of an incoming call with the calling party’s voice, while “Tone Call” uses a ring tone. A proprietary telephone user can select “Voice Call” or “Tone Call” in the Proprietary Telephone Settings. If the user selects “Voice Call”, the calling party can talk to the user immediately after the confirmation tone. The calling party can switch the pre-set mode at the called extension, from “Voice Call” to “Tone Call” or vice versa, by pressing “*” after dialing the extension number.



- A rotary telephone user cannot change the pre-set mode at the called extension.



- **Operating Instructions References**

- 1.2 Proprietary Telephone Settings, “Customizing Your Telephone Functions”,
Intercom Alert Assignment
- 1.7 Useful Features, “Alternate Calling – Ring/Voice”

Automatic Callback Busy (Camp-On)

When the selected outside (CO) line or dialed extension is busy, the system will automatically notify an extension user with a callback ringing when the line becomes available. When the user answers the callback ringing:

For an extension: The called extension starts ringing without dialing.

For an outside (CO) line: The line is seized.



- **Operating Instructions Reference**

- 1.3 Making Calls, “Making Your Telephone Ring Back Automatically When a Line Becomes Free (Automatic Callback Busy – Camp-On)”

Automatic Outside (CO) Line Access Number

An Automatic Line Access number (9 or 0) can be programmed. When an extension user dials an Automatic Line Access number before a telephone number, an available outside (CO) line from the assigned lines in program [419] is seized automatically. If “0” is selected in program [121], the operator call will be “9” automatically. If “9” is selected in program [121], the operator call will be “0” automatically.



- **Related Feature References**
Operator Call, Outside Calling
- **Required System Programming**
[121] Automatic Outside (CO) Line Access Number Selection
[419] Automatic Designated Outside (CO) Line Access

Automatic Route Selection (ARS)

The system automatically selects the least expensive route available at the time a long distance call is made on the outside (CO) line which has enabled the ARS feature. It is not necessary to dial the access code of the least expensive carrier.

1. Normal Use

To make a call via the least expensive carrier, the dialed number is modified. The following are modification examples.

Example 1 (Long distance call using Route 1):

- [350] “ARS Selection”: Enable
- [351] “Route 1 Selection Codes (Leading Digit)”: 9, 0
- [355] “Route 1 Exception Codes”: 07
- [360] “ARS Modification – Removed Digits”: 0 (No deletion)
- [361] “ARS Modification – Added Number”: 050 (Code of least expensive carrier for a long distance call)

<Dialed number>		<Modified number>
93 425 9477	→	050 93 425 9477
04 123 4567	→	050 04 123 4567

Example 2 (International call using Route 2):

- [350] “ARS Selection”: Enable
- [352] “Route 2 Selection Codes (Leading Digit)”: 07
- [360] “ARS Modification – Removed Digits”: 2
- [361] “ARS Modification – Added Number”: 05000 (Code of least expensive carrier for an international call)

<Dialed number>		<Modified number>
07 81 92 477 1450	→	050 00 81 92 477 1450

Example 3 (Long distance call via the first carrier):

- [350] “ARS Selection”: Enable
- [359] “1st Carrier Selection Code”: 000

<Dialed number>		<Modified number>
000 93 425 9477	→	93 425 9477

2. Special Use

If an extension user always uses the Automatic Line Access number (9 or 0) when making an outside call and wants to seize the specified outside (CO) line group as below automatically, refer to the following program assignment.

<Example>

- Outside (CO) line group which connects with the least expensive carrier for a long distance call (Long distance calls start with “9” or “0”. Carrier code = 050)
- Outside (CO) line group which connects with the least expensive carrier for an international call (International calls start with “07”. Carrier code = 05000)
- Outside (CO) line group connected with a mobile jack (Mobile telephone calls start with “6”.)

To specify how to modify the dialed number, and specify an outside (CO) line group for each route

Program Address Route No.	[351] [354]	[355] [358]	[360]	[361]	[364]
Route 1	9, 0	07	0 digit	050	outside line group number 1
Route 2	07		2 digits	05000	outside line group number 1
Route 3	6		0 digit		outside line group number 2

To specify outside (CO) lines in the outside (CO) line groups

Program Address Outside (CO) Line No.	[404] Outside (CO) Line Group Assignment	[350]	[419] Automatic Designated Outside (CO) Line Access
1	outside line group number 1	Enable	Enable
2	outside line group number 1	Enable	Enable
3	outside line group number 2	Enable	Disable

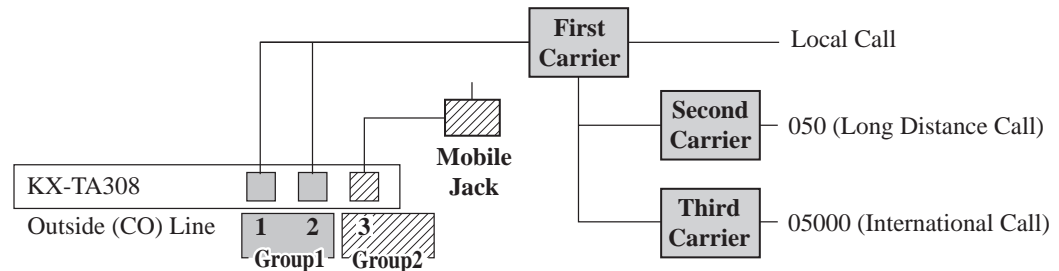

Example 5 [Long distance call using Route 1 (outside line group number 1)]:

<Dialed number>		<Modified number>
9 93 425 9477	→	050 93 425 9477
9 04 123 4567	→	050 04 123 4567

Example 6 [International call using Route 2 (outside line group number 1)]:

<Dialed number>		<Modified number>
9 07 81 92 477 1450	→	050 00 81 92 477 1450

Example 7 [Mobile telephone call using Route 3 (outside line group number 2)]:

<Dialed number>		<Modified number>
9 6 123456	→	6 123456



- System Programming is required to execute this feature.
- If an extension user makes an outside call using the Automatic Line Access number (9 or 0) and the dialed number does not apply to any numbers assigned in programs [351]–[354], an outside (CO) line which has selected “Enable” in program [419] “Automatic Designated Outside (CO) Line Access” is automatically seized.



- **Required System Programming**

- [350] ARS Selection
- [351]–[354] Routes 1 through 4 Selection Codes (Leading Digits)
- [355]–[358] Routes 1 through 4 Exception Codes
- [359] 1st Carrier Selection Code
- [360] ARS Modification – Removed Digits
- [361] ARS Modification – Added Number
- [362] ARS Dial Tone Pattern Selection
- [363] ARS Interdigit Time
- [364] ARS Outside (CO) Line Group

Flow chart of possible cases and results for ARS calls

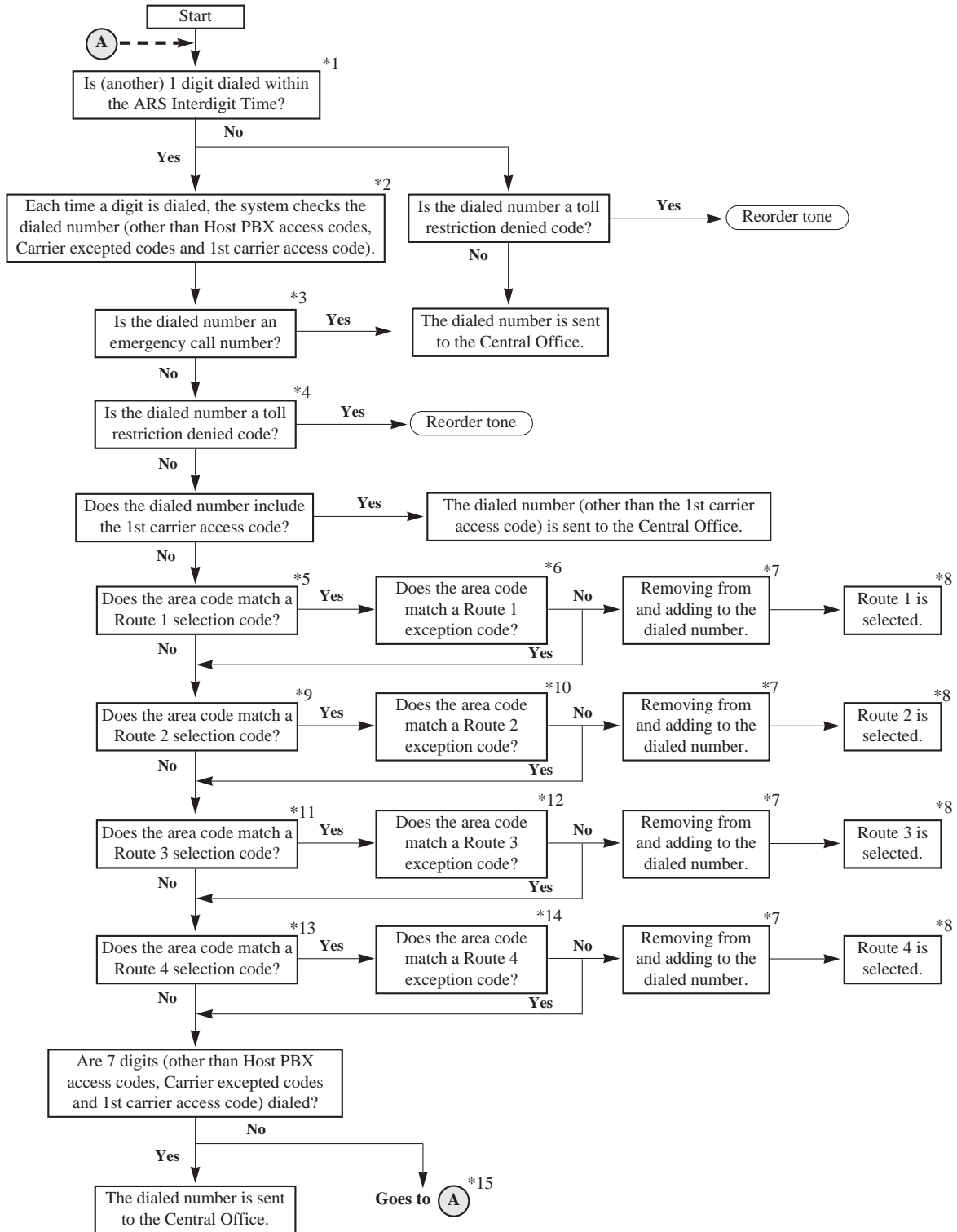

Note: The explanation for *1 through *15 is on the next page.

- *1: The ARS Interdigit timer is assigned in program [363] “ARS Interdigit Time”.
- *2: The codes are assigned in the following programs.
 Host PBX access codes: [403] “Host PBX Access Codes”
 Carrier excepted codes: [300] “Carrier Excepted Code Assignment”
 1st carrier access code: [359] “1st Carrier Selection Code”.
- *3: Emergency call numbers are assigned in program [309] “Emergency Dial Number Set”.
- *4: Toll restriction denied codes are assigned in program [302]-[305] “Toll Restriction – Classes 2 through 5 Denied Codes”.
- *5: Route 1 selection codes are assigned in program [351] “Route 1 Selection Codes (Leading Digits)”.
- *6: Route 1 exception codes are assigned in program [355] “Route 1 Exception Codes”.
- *7: Removing digits are assigned in program [360] “ARS Modification – Removed Digits” and added numbers are in [361] “ARS Modification – Added Number”.
- *8 The outside (CO) line group(s) assigned in program [364] is (are) automatically seized when making a call using the Automatic Outside (CO) Line Access number (9 or 0).
- *9: Route 2 selection codes are assigned in program [352] “Route 2 Selection Codes (Leading Digits)”.
- *10: Route 2 exception codes are assigned in program [356] “Route 2 Exception Codes”.
- *11: Route 3 selection codes are assigned in program [353] “Route 3 Selection Codes (Leading Digits)”.
- *12: Route 3 exception codes are assigned in program [357] “Route 3 Exception Codes”.
- *13: Route 4 selection codes are assigned in program [354] “Route 4 Selection Codes (Leading Digits)”.
- *14: Route 4 exception codes are assigned in program [358] “Route 4 Exception Codes”.
- *15: The system repeats checking until 7 digits are dialed.

Busy Station Signaling (BSS)

When an extension user calls a busy extension, the busy extension will hear a Call Waiting tone to know that a call is waiting.



- This feature is only available if the called extension has set the Call Waiting feature. If the Call Waiting feature is activated, the caller will hear a ringback tone. If not, the caller will hear a reorder tone.



- **Related Feature Reference**
Call Waiting
- **Operating Instructions Reference**
1.3 Making Calls, “Sending a Call Waiting Tone to a Busy Extension (Busy Station Signaling — BSS)”

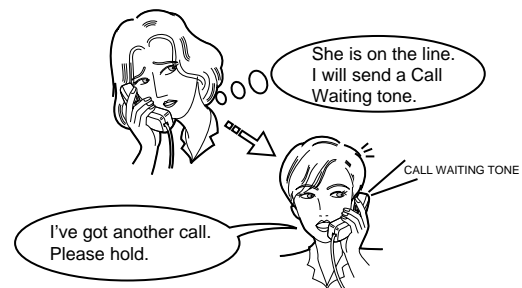

Call Forwarding

Allows an extension user to transfer incoming calls automatically to another extension or to an external destination. The following types are available.

- All Calls:** All incoming calls are forwarded to another extension.
- Busy or No Answer:** All incoming calls are forwarded to another extension when the extension user does not answer within the programmed time in [202] or when the extension is busy.
- To an Outside(CO) Line:** Allows an extension user enabled in program [607] to forward all incoming calls to an external party.
- Follow Me:** Allows an extension user to set the Call Forwarding – All Calls feature from another extension.



- Extensions which have already been assigned as a forwarded destination cannot set the Call Forwarding feature.
- If the Do Not Disturb (DND) feature has already been set, setting the Call Forwarding feature will cancel DND.
- The Call Forwarding – to Outside (CO) Line feature will forward all incoming intercom calls and certain kinds of incoming outside calls. These outside calls must arrive on outside (CO) lines whose programming, [414]-[416] “Outside (CO) Line Mode — Day/Night/Lunch”, is one of the following:
 - 1) DIL
 - 2) DISA1 or DISA2 (only when the call is directly sent to an extension, not intercepted)
 - 3) UCD (only when the UCD group has one member)
- If a call between 2 outside parties is established by the Call Forwarding – to Outside (CO) Line feature, the duration of the call is determined by the system timer assigned in program [205]. An alarm tone is generated to both outside parties 15 seconds before the timeout. The call will be disconnected at the timeout.



- **Required System Programming**
 - [202] Call Forwarding Start Time
 - [205] Outside-to-Outside (CO-to-CO) Line Duration Time Limit
 - [607] Call Forwarding to an Outside (CO) Line
- **Related Feature Reference**
 - Limited Call Duration
- **Operating Instructions References**
 - 1.2 Proprietary Telephone Settings, “Customizing the Buttons on Your Telephone”, FWD/DND (Forward/Do Not Disturb) Button
 - 1.6 Before Leaving Your Desk, “Forwarding a Call (Call Forwarding)”

Calling Party Control (CPC) Signal Detection

The Calling Party Control (CPC) signal is a disconnect signal sent from the Central Office for an outside call. The CPC signal detection is activated by programs [420] and [421]. Program [420] is for incoming outside calls, and [421] is for outgoing outside calls.



- **Required System Programming**
 - [420] Calling Party Control (CPC) Signal
 - [421] CPC Detection for Outgoing Calls

Call Park

Allows an extension user to place a held call into a system parking area. Any extension user can retrieve the parked call to perform other operations. Up to 10 calls can be parked at the same time.



- If a parked call is not retrieved within the assigned time in program [200], a ring tone or an alarm tone will be heard.
- If a parked call is not retrieved within 30 minutes, it will be automatically disconnected.
- This feature is useful when an extension user wants to hold more than one intercom call with a proprietary telephone, or more than one intercom call or outside call with a single line telephone.
- During a 5-party conference, this feature cannot be performed.



- **Required System Programming**
 - [200] Hold Recall Time
- **Related Feature Reference**
 - Conference (5-party)
- **Operating Instructions Reference**
 - 1.5 During Conversation, "Placing a Call in System Parking Area (Call Park)"

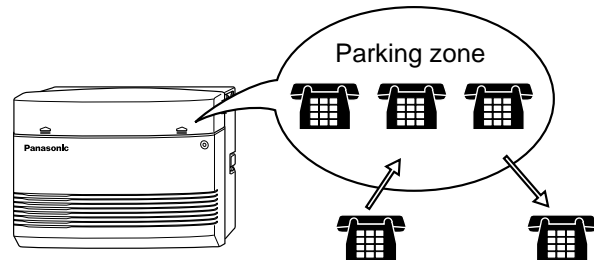

Call Pickup

<Directed Call Pickup>

Allows an extension user to answer a call ringing at any other extension.

<Group Call Pickup>

Allows an extension user to answer a call ringing at another extension, if the call is ringing within the user's extension group assigned in program [600]. If "Enable" is selected for an extension group in [127], persons in the group can pickup calls just by going off-hook, even though their extension is not ringing.

<Call Pickup Deny>

Allows an extension user to prevent other extensions from picking up a call ringing at the user's extension with the Call Pickup feature.

<Call Retrieving from a TAM (Telephone Answering Machine)>

Allows an extension user to answer an incoming call received by a TAM extension assigned in program [611].



- The user can pick up an incoming outside, intercom or doorphone call with the Directed Call Pickup or Group Call Pickup feature.
- A confirmation tone is sent to the user when the call is picked up with the Directed Call Pickup or Group Call Pickup feature. The tone can be disabled in program [117].
- If a ringing extension sets the Call Pickup Deny feature, an extension user will hear a reorder tone when the user tries to pick up the call.



• Required System Programming

- [117] Call Pickup Tone
- [127] Pickup Group Set
- [600] Extension Group Assignment
- [611] TAM (Telephone Answering Machine) Extension

• Operating Instructions Reference

- 1.4 Receiving Calls, "Picking up a Call Ringing at Another Extension (Call Pickup)"



Call Splitting

Allows an extension user to talk to 2 different parties. If a call is received while the user is already on the line, the user can place the current call on hold and have a conversation with the other party.



- This feature is not possible for a doorphone call, page or 5-party conference.



• Related Feature References

- Conference (5-party), Doorphone Call, Paging

• Operating Instructions Reference

- 1.5 During Conversation, "Call Splitting"

Call Transfer – to Extension

Allows an extension user to transfer a received call, an intercom or an outside call, to another extension. Two types are available.

Screened Call Transfer: Announces the call to another extension before completing the transfer.

Unscreened Call Transfer: Immediately releases the call to another extension without an announcement.



- If the destination extension does not answer the call within the assigned time in program [201], the call will return to the transferring party.
- An outside call can be transferred to an extension by simply pressing a DSS button. It requires program [005].
- If Music on Hold is enabled, music is sent to the original external caller while being transferred. Sending a cyclic tone or music on hold can be programmed by program [111].
- During a 5-party conference, the user cannot transfer a call.



- **Required System Programming**
 - [005] One-Touch Transfer Using a DSS Button
 - [111] Hold Music Selection
 - [201] Transfer Recall Time
- **Related Feature References**
 - Conference (5-party), Hold, Music on Hold
- **Operating Instructions Reference**
 - 1.5 During Conversation, “Transferring a Call to an Extension (Call Transfer – to Extension)”

Call Transfer – to Outside (CO) Line

Allows an extension user enabled in program [606] to transfer a received call, an intercom call or an outside call, to an external party.



- If a call between 2 external parties is established using this feature, an alarm tone will be sent to both parties 15 seconds before the assigned time limit in program [205]. Also, a ring tone or an alarm tone will be sent to the extension who transferred the call 50 seconds before the timeout. The call will be disconnected at the timeout unless the extension joins the conversation again.
- A single line telephone user cannot transfer a received call to an external party.
- If Music on Hold is enabled, music will be sent to the original external caller while being transferred. Sending a cyclic tone or music on hold can be programmed by program [111].
- To join the conversation again after transferring the call, press the corresponding CO button. A conference call will be established. This feature is not available for a single line telephone.



- **Required System Programming**

- [111] Hold Music Selection
- [205] Outside-to-Outside (CO-to-CO) Line Duration Time Limit
- [606] Call Transfer to an Outside (CO) Line

- **Related Feature Reference**

Hold, Music on Hold

- **Operating Instructions Reference**

- 1.5 During Conversation, “Transferring a Call to an Outside (CO) Line (Call Transfer – to Outside (CO) Line)”

Call Waiting

During a conversation, a Call Waiting tone informs an extension user that there is a call waiting. The user can answer the second call by disconnecting the first call or placing it on hold. When Call Waiting is enabled, a Call Waiting tone is sent to the user under the following conditions.

- 1) When an outside call (except a doorphone call) is received, or
- 2) When another extension executes the Busy Station Signaling (BSS) feature.



- For proprietary telephone users, a Call Waiting tone (Tone 1 or Tone 2) can be selected in the Proprietary Telephone Settings. Tone 2 depends on System Programming. Program [423] is for outside calls and program [115] is for intercom calls.

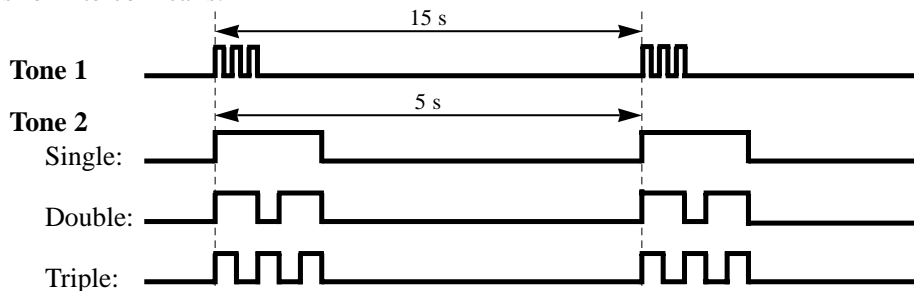

- **Required System Programming**

- [115] Extension Ringing Pattern Selection
- [423] Outside (CO) Line Ringing Pattern Selection

- **Related Feature Reference**

Hold

- **Operating Instructions References**

- 1.2 Proprietary Telephone Settings, “Customizing Your Telephone Functions”, Call Waiting Tone Selection
- 1.5 During Conversation, “Call Waiting”

Conference (3-party)

<Conference>

During a 2-party conversation, an extension user can add a third party to make a 3-party conference. The maximum number of members of a conference can be programmed in program [116].

<Conference, Unattended>

When a proprietary telephone user is in a 3-party conference with 2 external parties, the user can leave the conference to allow the other 2 parties to continue the conversation. This is called an Unattended Conference. The user may return to the conference, if desired.



- The possible combinations, through System Programming, are 3 extensions, 1 extension and 2 external parties, or 2 extensions and 1 external party.
- When a 2-party call is changed to a 3-party call or vice versa, a confirmation tone is sent to all 3 parties. The tone can be disabled by program [105].
- A 3-party call can also be established by the Executive Busy Override feature.
- The duration of an Unattended Conference can be limited in program [205]. The call is disconnected when the assigned time limit expires unless the extension which leaves the conference returns to it.
- An Unattended Conference can be established when the extension is allowed to transfer a call to an outside (CO) line by program [606].



• Required System Programming

- [105] Conference Tone
- [116] Conference Pattern Selection
- [205] Outside-to-Outside (CO-to-CO) Line Duration Time Limit
- [606] Call Transfer to an Outside (CO) Line

• Related Feature References

- Limited Call Duration, Executive Busy Override

• Operating Instructions References

- 1.2 Proprietary Telephone Settings, “Customizing the Buttons on Your Telephone”, CONF (Conference) Button
- 1.7 Useful Features, “Conference (3-party)”
- 1.7 Useful Features, “Conference, Unattended”

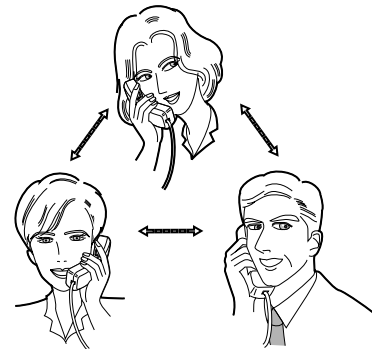

Conference (5-party)

Allows an extension user to establish a 5-party conference when “5 party C-2 E-5” is selected in program [116].



- Up to 2 external parties can participate in a conference call.
- All 5 parties can be extensions.
- Only one 5-party conference can be established at one time.
- When a 5-party conference is established, a confirmation tone is sent to all parties. The tone can be disabled by program [105].
- The Unattended Conference, Executive Busy Override features, and the Call Park feature by another extension are not available during a 5-party conference.



- **Required System Programming**
 - [105] Conference Tone
 - [116] Conference Pattern Selection
- **Related Feature References**
 - Conference (3-party), Call Park, Executive Busy Override
- **Operating Instructions References**
 - 1.2 Proprietary Telephone Settings, “Customizing the Buttons on Your Telephone”, CONF (Conference) Button
 - 1.7 Useful Features, “Conference (5-party)”

Data Line Security

Prevents an extension user from being interrupted by the Call Waiting and Executive Busy Override features. This feature also prevents a ring tone or an alarm tone from being sent when a call is kept waiting longer than a pre-determined time. Data communication devices, such as computers and facsimiles, connected to an extension jack can operate without interruptions.



- **Related Feature References**
 - Call Waiting, Executive Busy Override
- **Operating Instructions Reference**
 - 1.7 Useful Features, “Data Line Security”

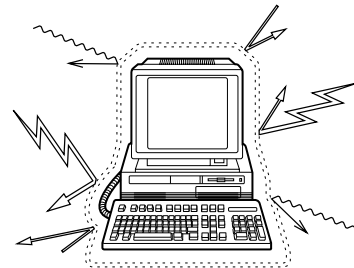

Date and Time Setting

A manager or operator can adjust the current time.



- **Required System Programming**
[000] Date and Time Setting
- **Operating Instructions Reference**
1.8 Operator / Manager Service Features, “Date and Time Setting”

Direct In Line (DIL)

Enables an incoming outside call to go directly to a specified extension. This outside (CO) line can be used by multiple extension users to make a call, but can only be used by one extension to receive a call. DIL can have a different destination in the day, night and/or lunch modes.



- If the destination extension is in an extension group which has enabled the Station Hunting feature in program [100] “Hunting Group Set”, Station Hunting (Terminate or Circular in program [101] “Hunting Type”) works when the extension is busy.



- **Required System Programming**
[414]–[416] Outside (CO) Line Mode — Day/Night/Lunch
- **Related Feature References**
Station Hunting, Time (Day/Night/Lunch) Service

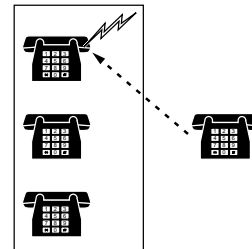

Direct Inward System Access (DISA)

Allows an outside caller to access specific system features as if the caller is an extension in the system. The caller can have direct access to features such as:

- Placing an incoming call to an extension, extension group or operator. The caller also has the option of dialing the route for an extension using a 1 digit number (DISA built-in auto attendant number) via DISA calls.
- Calling an external party.

One of the following must be selected in program [511] to have direct access to these features:

(1) None Security, (2) Trunk (Outside (CO) Line) Security, or (3) All Security.

None Security: Any caller can make outside or intercom calls.

Trunk Security: A pre-assigned DISA security code must be entered to make outside calls.

All Security: A pre-assigned DISA security code must be entered to make both outside and intercom calls.

This prevents the caller from making unauthorized calls. However, when making an outside call by Call Forwarding – to Outside (CO) Line, the call is allowed (exception).

The DISA feature operates without an optional card installed. If an outgoing message (OGM) which greets a caller and gives information, or fax detection is required, an optional OGM/FAX Detection Card must be installed. The system can detect a FAX (CNG) tone according to program [514]. An OGM can be programmed in program [502] (☞ “Outgoing Message (OGM)” in this section). When a caller reaches a DISA line, a message will greet the caller. Two different DISA messages can be recorded by the operator or manager. For example, one message can be used in day mode and the other in night mode, or they can be used for different outside (CO) lines. If an optional OGM/FAX Detection Card is not installed, the caller will hear a short beep instead of the OGM (Internal DISA).



- “DISA1” or “DISA2” must be assigned to outside (CO) line(s) as the outside (CO) line mode in programs [414] through [416].
- After the DISA Delayed Answer Time assigned in program [504] expires and a ringback tone is returned to the caller, a DISA call will be answered. The caller can dial during the message or after the tone.
- This system can store up to 10 programmable DISA built-in auto attendant numbers in program [501]. Each number is 1 digit.
- The DISA built-in auto attendant number may be the same as the first digit of other numbers (extension number, etc.). To avoid confusion, the system waits for the second digit for a preprogrammed amount of time in program [517] (default: 2 seconds). If the timer expires, the system will assume that the first digit is a DISA built-in auto attendant number.
- Only one OGM/FAX Detection Card can be installed .
- The DISA line can be used to make outside calls, if a security code assigned in program [512] (if required) has been dialed.
- This system can store up to 4 programmable DISA security codes. Each code should be different.
- When a wrong DISA security code is entered, 3 beeps will be heard. The call will be disconnected after 3 failed attempts. If you enter a security code a second and third time, dialing * is not necessary.

- The duration of outside-to-outside (CO-to-CO) line calls can be limited in program [205]. When the specified time expires, both lines are disconnected. A warning tone is sent to both parties 15 seconds before the time-limit.
- To detect the end of an outside-to-outside (CO-to-CO) line call, CPC Signal Detection can be assigned. Programs [420] and [421] are required.



- **Connection Reference**

- 2.15 OGM/FAX Detection Card Installation

- **Required System Programming**

- To enable the DISA feature**

- [414]–[416] Outside (CO) Line Mode — Day/Night/Lunch

- [420] Calling Party Control (CPC) Signal

- [421] CPC Detection for Outgoing Calls

- [500] DISA Incoming Dialing Mode Selection

- [501] DISA Built-in Auto Attendant

- [502] OGM Mode Selection

- [503] FAX Connection

- [506] DISA Busy Mode

- [510] DISA No Dial Mode

- [511] DISA Security Type

- [512] DISA Security Codes

- [513] Cyclic Tone Detection

- [514] FAX Tone Detection

- [516] DISA Incoming Assignment

- [518] DISA Tone Selection after the Security Code

- To set DISA timer values**

- [205] Outside-to-Outside (CO-to-CO) Line Duration Time Limit

- [504] DISA Delayed Answer Time

- [505] DISA Waiting Time after OGM

- [517] DISA AA Wait Time

- [519] DISA OGM Mute Time

- To enable the Intercept Routing feature**

- [408]–[410] Flexible Ringing Assignment — Day/Night/Lunch

- [507] DISA Intercept Mode

- [508] DISA Ringing Time before Intercept

- [509] DISA Ringing Time after Intercept

- [515] Intercept Time for Internal DISA

- **Related Feature References**

- Intercept Routing, Outgoing Message (OGM), Polarity Reverse Detection, Station Hunting

DISA Operation

Calling an extension by following the outgoing message

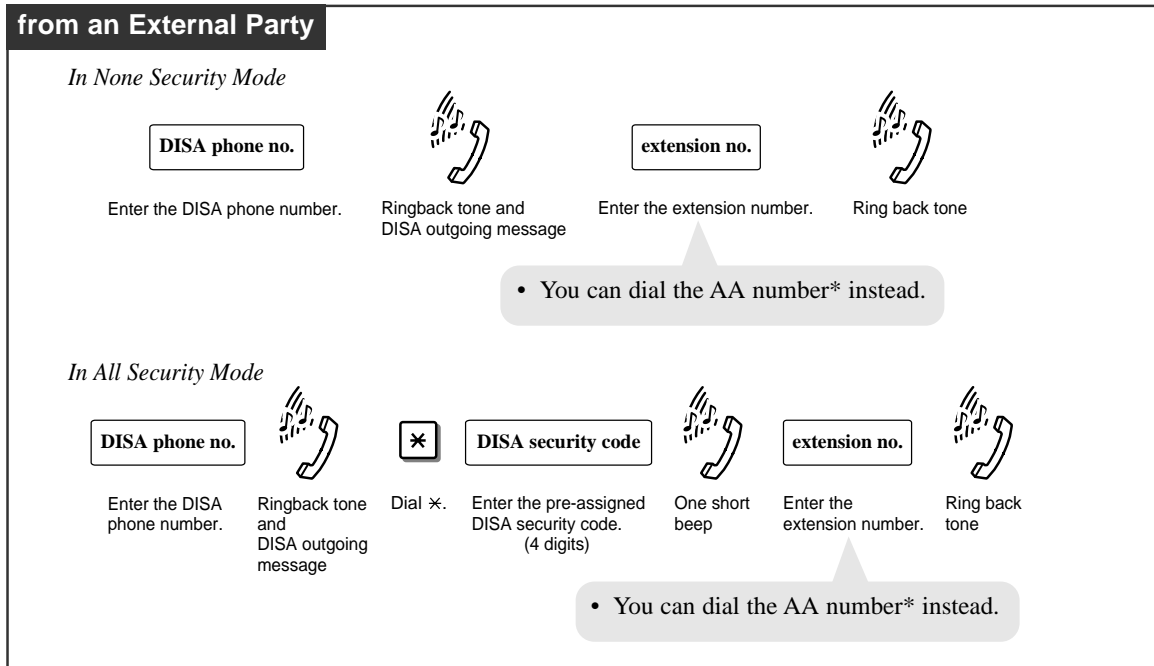

Calling an extension without an outgoing message (Internal DISA)

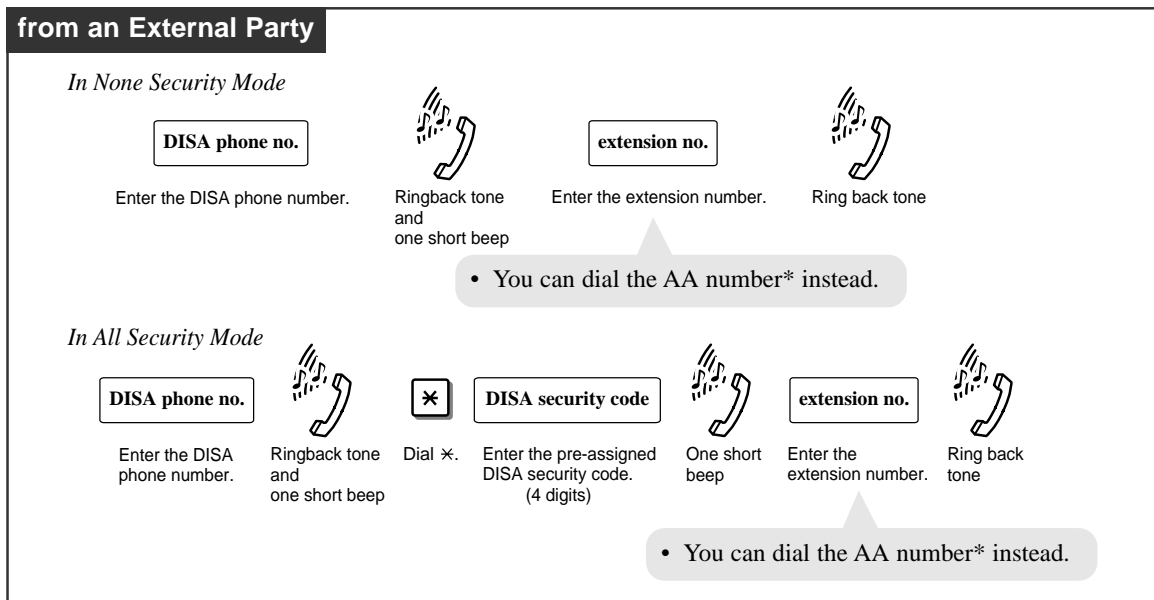



AA number*: A DISA built-in auto attendant number assigned in program [501] “DISA Built-in Auto Attendant”.





Calling an external party by following the outgoing message

from an External Party





In None Security Mode

DISA phone no.		line access code		phone no.
Enter the DISA phone number.	Ringback tone and DISA outgoing message	Enter a line access code (9 or 0, or 81 through 86).	Dial tone from the Central Office	Enter the phone number of the external party.

In Trunk Security Mode

DISA phone no.		 DISA security code		line access code		phone no.
Enter the DISA phone number.	Ringback tone and DISA outgoing message	Dial *. Enter the pre-assigned DISA security code. (4 digits)	One short beep	Enter a line access code (9 or 0, or 81 through 86).	Dial tone from the Central Office	Enter the phone number of the external party.



In All Security Mode

DISA phone no.		 DISA security code		line access code		phone no.
Enter the DISA phone number.	Ringback tone and DISA outgoing message	Dial *. Enter the pre-assigned DISA security code. (4 digits)	One short beep	Enter a line access code (9 or 0, or 81 through 86).	Dial tone from the Central Office	Enter the phone number of the external party.





Calling an external party without an outgoing message (Internal DISA)

from an External Party





In None Security Mode

DISA phone no.		line access code		phone no.
Enter the DISA phone number.	Ringback tone and one beep	Enter a line access code (9 or 0, or 81 through 86).	Dial tone from the Central Office	Enter the phone number of the external party.

In Trunk Security Mode

DISA phone no.		 DISA security code		line access code		phone no.
Enter the DISA phone number.	Ringback tone and one short beep	Dial *. Enter the pre-assigned DISA security code. (4 digits)	One short beep	Enter a line access code (9 or 0, or 81 through 86).	Dial tone from the Central Office	Enter the phone number of the external party.

In All Security Mode

DISA phone no.		 DISA security code		line access code		phone no.
Enter the DISA phone number.	Ringback tone and one short beep	Dial *. Enter the pre-assigned DISA security code. (4 digits)	One short beep	Enter a line access code (9 or 0, or 81 through 86).	Dial tone from the Central Office	Enter the phone number of the external party.

Flow chart of possible cases and results for DISA calls

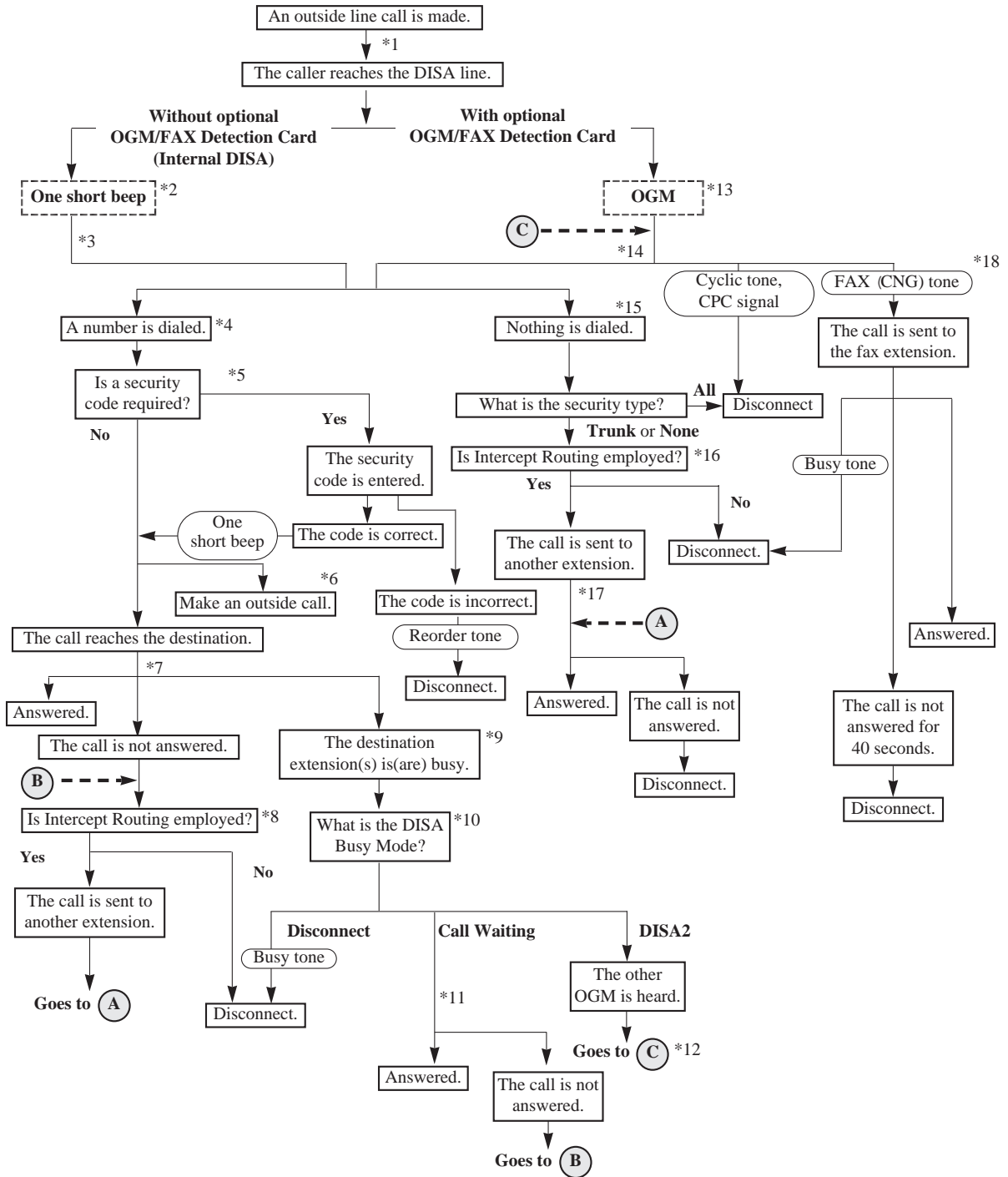

Note: The explanation for *1 through *18 is on the next page.

- *1: The DISA Delayed timer starts. This is the time between a call reaching the system and being received. The time is assigned in program [504].
- *2: When the assigned time period in program [519] expires, the system sends a short beep to the caller.
- *3: The Intercept Timer for Internal DISA starts. This is the time the system waits for the number sent by the caller. If nothing is entered by the caller during this time, the system will regard it as “Nothing is dialed.” The time is assigned in program [515].
- *4: The system can accept the following numbers:
- **100 through 199** as an extension number.
 - **81 through 86** as an outside (CO) line group line access number.
 - **9** as an automatic line access number when “Without AA” is assigned in program [500]. Even if “With AA” is assigned, 9 is regarded as the automatic line access number if nothing is assigned to “9” in program [501]. In case “9” is assigned as the operator call number in program [121] “Automatic Outside (CO) Line Access Number Selection”, 9 is regarded as the operator call number instead of an automatic line access number.
 - **0** as the operator call number when the operator is assigned in program [008] “Operator Assignment” and “Without AA” is assigned in program [500]. Even if “With AA” is assigned, 0 is regarded as the operator call number if nothing is assigned to “0” in program [501]. If “0” is assigned as an automatic line access number in program [121], 0 is regarded as an automatic line access number instead of the operator call number.
 - **0 through 9** as a built-in auto attendant number when “With AA” is assigned in program [500]. The DISA AA Wait timer starts after receiving the first 1-digit number. If the timer expires, the system will assume that the first digit is an AA number. The time is assigned in program [517].
- *5: A security code is necessary when program [511] is assigned as follows.
- **All Security** – The system waits for a security code dialed after “* ”. When the security code matches a code programmed in [512], the system accepts the numbers after the code.
 - **Trunk Security** – The caller can access an outside (CO) line if the security code matches a code programmed in [512]. The caller can access other destinations without the security code.
- If the entered number is the same as one of the security codes, a short beep will be heard. The short beep can be disabled by program [518]. If the number is wrong, 3 beeps will be heard. The call will be disconnected after 3 failed attempts.
- *6: The caller must enter the desired telephone number after hearing a dial tone from the Central Office.
- *7: The DISA Ring Timer Before Intercept starts. The destination telephone(s) will ring for the time programmed in [508].
- *8: The system treats the call according to program [507] as follows.
- **Disconnect** – The call is disconnected.
 - **Intercept** – The call is sent to the extensions programmed in [408]-[410] “Flexible Ringing Assignment – Day/Night/Lunch”.
- If the call is still not answered within the time programmed in [509], it will be disconnected.

-
- *9: If the destination extension belongs to a hunting group and all extensions in the group are busy, the system will check the DISA Busy Mode. If the destination is a DISA ring group, the DISA Busy Mode will not work for the call. The system regards the call as unanswered.
- *10: The DISA Busy Mode is selected in program [506]. There are 3 modes as follows.
- **Disconnect** – The caller hears a busy tone and a call is disconnected.
 - **Call Waiting** – The destination extension hears a call waiting tone if they have enabled Call Waiting.
 - **DISA2** – If “MODE2” is assigned in program [502] and a message is recorded in OGM2, the caller will hear the message and the system waits for the new destination.
- *11: The DISA Ring Timer Before Intercept starts. The destination telephone(s) will ring for the time programmed in [508].
- *12: In this case, the system disregards the security type and does not accept a line access code. If nothing is recorded in OGM2 or OGM2 is used for another caller, the caller will hear a busy tone and the call is disconnected.
- *13: The OGM is sent to the caller according to programs [414]–[416] and [502] when the assigned time in program [519] expires. If an OGM is not recorded, the DISA Wait Timer After OGM programmed in [505] starts immediately.
When the system detects a FAX (CNG) tone while the OGM is being sent, the call is sent to the FAX extension assigned in program [503]. When the system detects a cyclic tone or CPC signal while the OGM is being sent, the call is disconnected.
- *14: The DISA Wait Timer After OGM starts. The system waits for a number from the caller during the time assigned in program [505]. When the system detects a FAX (CNG) tone during the programmed time, the call is sent to the FAX extension. When the system detects a cyclic tone or CPC signal during the programmed time, the call is disconnected.
- *15: After the DISA Wait Timer After OGM or the Intercept Timer for Internal DISA expires, the system regards that nothing was dialed.
- *16: The system treats the call according to program [510] as follows.
- **Disconnect** – The call is disconnected.
 - **Intercept** – The call is sent to the extensions programmed in [408]–[410]. If all extensions are assigned to “Disable”, the call will be disconnected.
- *17: The DISA Ring Timer After Intercept starts. The destination telephone(s) will ring for the time programmed in [509]. If the call is not answered during the programmed time, the call will be disconnected.
- *18: The FAX extension assigned in program [503] receives the call. When the extension is busy, the system sends a busy tone to the sending FAX. If the call is not answered after 40 seconds, the call will be disconnected.
Program [514] sets how many times the FAX (CNG) tone must be detected before the system recognizes the incoming signal as facsimile data.

Display Contrast Adjustment **(KX-T7330/KX-T7030/KX-T7130/KX-T7033 only)**

Allows a display proprietary telephone user to adjust the display contrast with the CONTRAST selector.



- **Operating Instructions Reference**
1.2 Proprietary Telephone Settings, “Display Contrast Adjustment”

Distinctive Dial Tones

An extension user will hear 3 types of dial tone patterns which give information about the features activated on the telephone.

Dial Tone 1: This is a normal dial tone. None of the features listed in Dial Tone 2 are activated.



Dial Tone 2: Sent when any of the following features are set.

- Absent Message Capability
- Call Forwarding
- Data Line Security
- Electronic Station Lockout
- Pickup Dialing (for single line telephones only)
- Timed Reminder
- Background Music (BGM) (for proprietary telephones only)
- Call Pickup Deny
- Do Not Disturb (DND)
- Message Waiting (for proprietary telephones only)
- Remote Station Lock Control



Dial Tone 3: Sent when making an Account Code Entry and answering a Timed Reminder call. Also sent when going off-hook with a single line telephone which has a message in a Voice Processing System.



- **Operating Instructions Reference**
1.7 Useful Features, “Distinctive Dial Tones”

Do Not Disturb (DND)

<Do Not Disturb (DND)>

Allows an extension user to prevent other parties from disturbing them. The extension will not receive intercom or outside calls.

<Do Not Disturb (DND) Override>

Allows an extension user enabled in program [609] to call an extension which has set the Do Not Disturb (DND) feature.



- If your proprietary telephone (PT) is not supplied with the FWD/DND button, it can be assigned to a flexible CO button in the Proprietary Telephone Settings.
- DND does not work for the following calls: Hold recall or Timed Reminder.
- A PT user in the DND mode can answer a call by pressing the corresponding flashing button.
- If the Call Forwarding feature has already been set, setting the DND feature will cancel Call Forwarding.



• Required System Programming

[609] Do Not Disturb Override

• Related Feature References

Call Forwarding,
Timed Reminder

• Operating Instructions References

- 1.2 Proprietary Telephone Settings, “Customizing the Buttons on Your Telephone”, FWD/DND (Forward/Do Not Disturb) Button
- 1.7 Useful Features, “Rejecting Incoming Calls (Do Not Disturb — DND)”
- 1.7 Useful Features, “Calling an Extension which Denies Receiving Calls (Do Not Disturb Override)”

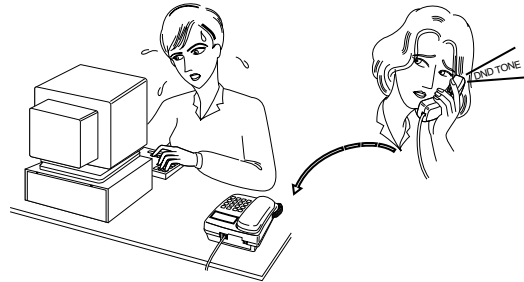

Door Opener

Up to 4 Door Openers can be connected to the system. The door can be unlocked by a pre-assigned extension users in programs [703]-[705].

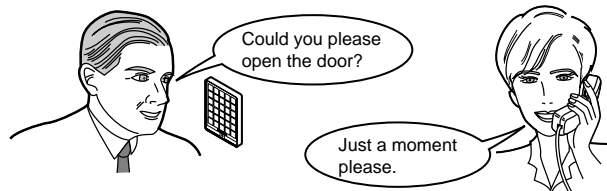

- An optional Doorphone/Door Opener Card must be installed to the system and a user-supplied door opener to the door to be opened. Four openers can be installed.
- The door opener will open the door even if a doorphone is not installed.
- The door opener timer can be modified in program [709].



- **Connection Reference**
 - 2.16 Doorphone and Door Opener Connection
- **Required System Programming**
 - [703]–[705] Door Opener Assignment — Day/Night/Lunch
 - [709] Door Opener Time
- **Related Feature Reference**
 - Doorphone Call
- **Operating Instructions Reference**
 - 1.7 Useful Features, “Door Opener”

Doorphone Call

Up to 4 Doorphones (KX-T30865) can be installed. If a visitor presses the doorphone button, a pre-assigned extension user in programs [700]–[702] can answer the call and talk to the visitor. Any extension user can call a doorphone. The doorphones are also used for the Room Monitor feature.



- An optional Doorphone/Door Opener Card must be installed to the system and a doorphone. Four doorphones can be installed.
- Doorphone 1 and 2 cannot be used simultaneously. When one is in use, an extension user cannot have a conversation with the other. Doorphone 3 and 4 are the same.
- An access tone can be programmed in [707] to be sent to a monitored doorphone before room monitoring starts.
- The ring tone from the doorphone call is programmable in [706].



- **Connection Reference**
 - 2.16 Doorphone and Door Opener Connection
- **Required System Programming**
 - [700]–[702] Doorphone Ringing Assignment — Day/Night/Lunch
 - [706] Doorphone Ringing/Tone Pattern Selection
 - [707] Doorphone Access Tone Selection
 - [708] Doorphone Ringing Time
- **Related Feature References**
 - Door Opener, Room Monitor
- **Operating Instructions References**
 - 1.7 Useful Features, “Room Monitor”
 - 1.7 Useful Features, “Doorphone Call”

DSS Console

The Direct Station Selection (DSS) Console provides direct access to extensions, a busy lamp display, as well as 16 PF (Programmable Feature) buttons.

The DSS Console must be programmed to work with a proprietary telephone (PT). The jack number of the DSS Console and its associated PT are assigned in programs [003] and [004].

Up to 2 consoles can be installed per system.

If a feature like One-Touch Dialing is assigned to a DSS button or PF button, accessing the feature can be done easily by pressing the corresponding button. This is very useful for an operator or manager. Refer to the Operating Instructions for more details.



- Programming the DSS and PF buttons can be done only from the paired telephone.
- Indicating the Forward (FWD) or Do Not Disturb (DND) status of corresponding extensions using a DSS button indication is programmable in [112].



- **Connection Reference**
2.8 Extension Connection
- **Required System Programming**
[003] DSS Console Port Assignment
[004] Paired Telephone Assignment for DSS Console
[112] DSS Console Indication Mode
- **Operating Instructions Reference**
1.9 DSS Console Features

Emergency Call

Allows an extension user to access a pre-assigned emergency number which can be dialed regardless of any restrictions.



- Up to 5 emergency numbers can be stored.
- An emergency call is allowed even in the following cases;
 - in Account Code Modes (Verify-All and Forced modes),
 - in any toll restriction COS number, and
 - in Electronic Station Lockout.



- **Required System Programming**
[309] Emergency Dial Number Set
- **Related Feature References**
Account Code Entry, Toll Restriction, Station Lock
- **Operating Instructions Reference**
1.3 Making Calls, “Making Emergency Calls (Emergency Call)”

Executive Busy Override

<Executive Busy Override – Extension>

Allows an extension user enabled in program [608] to interrupt an existing intercom call. A 3-party conference will be established.

<Executive Busy Override – Outside (CO) Line>

Allows a proprietary telephone user enabled in program [608] to interrupt an existing outside call or add a third party. A 3-party conference will be established.

<Executive Busy Override Deny>

Allows an extension user to prevent other extension users from interrupting their conversation.



- The Executive Busy Override feature will not work if the extension engaged the conversation has set Executive Busy Override Deny or Data Line Security.
- When a 3-party call is changed to a 2-party call or vice versa, a confirmation tone will be sent to all parties. This tone can be disabled by program [105].



- **Required System Programming**
 - [105] Conference Tone
 - [608] Executive Busy Override
- **Related Feature Reference**
 - Conference (3-party)
- **Operating Instructions References**
 - 1.3 Making Calls, “Interrupting an Existing Call (Executive Busy Override)”
 - 1.3 Making Calls, “Denying ‘Interrupting an Existing Call’ (Executive Busy Override Deny)”

Extension Button Confirmation (KX-T7330/KX-T7030/KX-T7130/KX-T7033 only)

Allows a display proprietary telephone user to confirm the values stored in the buttons, such as the REDIAL button or flexible CO button, by pressing the corresponding button while on-hook.



- **Operating Instructions Reference**
 - 1.7 Useful Features “Extension Button Confirmation (KX-T7330/KX-T7030/KX-T7130/KX-T7033 only)”

Extension Group

The system supports 8 extension groups. In an extension group, the following features can be activated.

- **Group Call Pickup:** Any member of an extension group can pick up a call directed to another member in the same group.
- **Paging – Group:** Any member of an extension group can make a voice announcement to another group member.

A hunting group, DISA ring group or UCD group is a specific extension group. The following operation as well as the features above can be activated for a hunting group, DISA ring group or UCD group.

Hunting Group

An extension group enabled in program [100] “Hunting Group Set” will perform the Station Hunting feature. See “Station Hunting” in this section.

DISA Ring Group

All extensions in a DISA ring group assigned as an auto attendant destination in program [501] “DISA Built-in Auto Attendant” will ring simultaneously. Selecting “DISA1” or “DISA2” in programs [414]–[416] “Outside (CO) Line Mode — Day/Night/Lunch” is required. Also, you must select “With AA” in program [500] “DISA Incoming Dialing Mode Selection”.

UCD Group

One extension group assigned as the UCD group in program [520] “UCD Group” can be the destination of incoming outside calls via the UCD feature. Selecting “UCD” in programs [414]–[416] “Outside (CO) Line Mode — Day/Night/Lunch” is required.



- **Required System Program Address**
[600] Extension Group Assignment
- **Related Feature References**
Call Pickup, Direct Inward System Access (DISA), Paging, Station Hunting, Uniform Call Distribution (UCD)

Extension Password / System Password

The extension password assigned by the manager (extension jack 01) to each extension can be used for the Walking COS feature. The system password is used for entering System Programming and also before assigning the extension password.



- **Required System Programming**
[002] System Password
- **Related Feature References**
Walking COS
- **Operating Instructions Reference**
1.8 Operator / Manager Service Features, “Extension Password Set (Manager only)”

External Feature Access

Allows an extension user to access special features (e.g. Call Waiting) offered by the Central Office or host PBX. This is done by placing the current call on hold and sending a flash signal using either the FLASH button or the feature number. This feature is effective only during an outside call.



- When “MODE2” is selected in program [110] and the FLASH button is pressed for longer than the time programmed in [418], this feature will not work.
- The flash time must be assigned in program [418] as required by the host PBX or outside (CO) line.



- **Required System Programming**
 - [110] Flash Key Mode
 - [418] Flash Time
- **Related Feature References**
 - Flash, Host PBX Access
- **Operating Instructions Reference**
 - 1.7 Useful Features, “External Feature Access”

Flash

The FLASH button is used to allow a proprietary telephone user to disconnect the current call and originate another call without hanging up. This is activated when “MODE2” is selected in program [110] and the FLASH button is pressed for longer than the time programmed in [418]. When “MODE1” is selected in program [110], the FLASH button can be used to access features of the Central Office or host PBX (External Feature Access). It is performed by putting the current party on hold and sending a flash signal while having an outside call.



- Assigning the External Feature Access feature to any flexible button is useful when “MODE 2” was selected in program [110]. This can be done from any extension by assigning the FLASH button to a One-Touch Dialing button (☞ Operating Instructions, 1.2 Proprietary Telephone Settings, “Customizing the Buttons on Your Telephone”, One-Touch Access for System Features). When the assigned button is pressed, a flash signal is sent during the programmed time in [418].



- **Required System Program Address**
 - [110] Flash Key Mode
 - [418] Flash Time
- **Operating Instructions Reference**
 - 1.7 Useful Features, “External Feature Access”

Flexible Buttons

A proprietary telephone (PT) user can change the flexible buttons on the telephone and DSS console to certain function buttons. For example, if the telephone has more CO buttons than available outside (CO) lines, the unused CO buttons may be changed to One-Touch Dialing buttons, etc.

The 4 types of flexible buttons are as follows:

- **Flexible CO Buttons** (located on a PT only)
- **Flexible DSS Buttons** (located on a DSS Console only)
- **Programmable Feature (PF) Buttons** (located on a PT and DSS Console)
- **Flexible MESSAGE Buttons** (located on a PT except for the KX-T7055)

Check the required operation first. If the telephone is not provided with the button, assigning the button can be performed in the Proprietary Telephone Settings.

Function	Programmable Button			
	CO	DSS	PF	MESSAGE
DSS (Direct Station Selection)	✓	✓		✓
One-Touch Dialing	✓	✓	✓	✓
CONF (Conference)	✓			
FWD/DND (Forward/Do Not Disturb)	✓			
SAVE	✓			
Log-In/Log-Out	✓			
Single-CO (S-CO)	✓			
Other CO (O-CO)	✓			
Group-CO (G-CO)	✓			
MESSAGE (Message Waiting)				✓
Day		✓		
Night		✓		
Lunch		✓		
Station Lock		✓		

“✓” indicates that the feature is available.



- **Operating Instructions Reference**
1.2 Proprietary Telephone Settings, “Customizing the Buttons on Your Telephone”

Handset/Headset Selection

(KX-T7330/KX-T7030/KX-T7130/KX-T7033 only)

The system supports the use of headsets with proprietary telephones. Switch the selection mode before using the headset (optional).



- **Operating Instructions Reference**
1.2 Proprietary Telephone Settings, “When Using the Headset”

Handsfree Answerback

Allows a proprietary telephone with a speakerphone to answer an intercom call without lifting the handset. This feature performed by pressing the AUTO ANSWER/MUTE or AUTO ANS/MUTE button.



- This feature does not work for incoming outside calls or doorphone calls.



- **Operating Instructions Reference**
1.4 Receiving Calls, “Handsfree Answerback”

Handsfree Operation

Allows a proprietary telephone user to dial and talk to the other party without lifting the handset. Pressing one of the following buttons activates the handsfree mode when the SP-PHONE/MONITOR button indicator is off:

SP-PHONE button, MONITOR button, INTERCOM button, or CO button.



- The KX-T7350, the KX-T7050 and the KX-T7055 can perform handsfree dialing operations, etc., but cannot have a handsfree conversation.



- **Operating Instructions Reference**
1.3 Making Calls, “Handsfree Operation”

Hold

<Call Hold>

Allows an extension user to place an intercom and/or outside call. The held call can be retrieved by the user who held it, or by any other extension (Call Hold Retrieve).

With a single line telephone (SLT), either one outside or intercom call can be held at one time. If an SLT user want to hold both calls, use the Call Park feature. An SLT user can select how to operate the Call Hold feature by program [104].

<Exclusive Hold>

Allows an proprietary telephone user to prevent other extension users from retrieving their held call. Only the user who held the call can retrieve it. This feature is not available for an SLT.



- Only one intercom call can be placed on hold. For a proprietary telephone, outside calls and one intercom call can be placed on hold at the same time.
- If a held call is not retrieved within the assigned time in program [200], the extension user who held it will hear a ring tone or an alarm tone. If the user is on-hook and their SP-PHONE/MONITOR button indicator is off, the phone will ring (Hold Recall). If the user is off-hook or in the handsfree mode, an alarm tone will be sent to the built-in speaker of a proprietary telephone or the handset receiver of a single line telephone at 15-second interval (Hold Alarm).
If “Disable” is selected in program [200], nothing will be heard.
- If a held outside call is not answered within thirty minutes, it will be automatically disconnected.
- For outside calls, music is sent to the external party on hold, if available (Music on Hold).
- During a 5-party conference, the Hold feature cannot be activated.



• Required System Programming

- [104] Hold Mode Selection
- [200] Hold Recall Time

• Related Feature References

Call Park, Music on Hold, Background Music (BGM), Hookswitch Flash

• Operating Instructions References

- 1.5 During a Conversation, “Placing a Call on Hold (Call Hold)”
- 1.5 During a Conversation, “Placing a Call on Hold Exclusively (Exclusive Hold)”
- 1.5 During a Conversation, “Retrieving a Call on Hold (Call Hold Retrieve)”

Hookswitch Flash

Flashing the hookswitch is used to allow a single line telephone user to hold a call for transferring or holding, if the flash time is within the assigned time in program [207]. The procedure to transfer a call or hold is determined in program [104] "Hold Mode Selection". Flashing the hookswitch can be also used to disconnect a call, if the flash time is more than the assigned time in program [207].



- If "MODE 1" was selected in program [207], the system will recognize flashing the hookswitch as hooking, while a busy tone or reorder tone is sent or during a conversation. The system will recognize as 1 being dialed in the pulse mode, while a dial tone is sent. The system can refuse receiving a pulse signal by selecting "Disable" in program [614]. Therefore, even if the hookswitch is flashed during a dial tone, the system will regard it as hooking.



- **Required System Programming**
[207] Hookswitch Flash Timing Range Selection
[614] Internal Pulse Detection

Host PBX Access

The system may be installed behind an existing host PBX. This is performed by connecting a line from the host to an outside (CO) line in the system.



- A Host PBX Access code assigned in program [403] is required to access an outside (CO) line of the host PBX.
- Access to the host PBX during a conversation is also possible (External Feature Access).



- **Required System Programming**
[403] Host PBX Access Codes
[417] Pause Time
- **Related Feature Reference**
External Feature Access

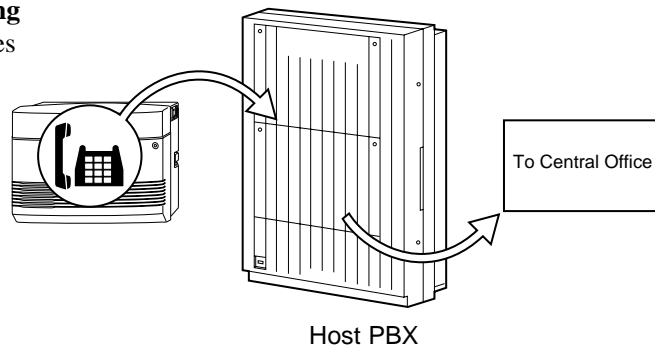

Intercept Routing

Provides automatic redirection of incoming outside calls via the DISA or UCD feature. The Intercept Routing feature works in the following 2 cases.

- 1) When nothing is dialed after a dial tone or OGM is sent to the caller. (The DISA feature only)
- 2) When the call is not answered within a programmed time. This is called Intercept Routing – No Answer (IRNA).



- **Required System Programming**

- [408]–[410] Flexible Ringing Assignment — Day/Night/Lunch
- [507] DISA Intercept Mode
- [508] DISA Ringing Time before Intercept
- [509] DISA Ringing Time after Intercept
- [510] DISA No Dial Mode
- [523] UCD Busy Mode
- [524] UCD Intercept Mode
- [525] UCD Ringing Time before Intercept
- [526] UCD Ringing Time after Intercept

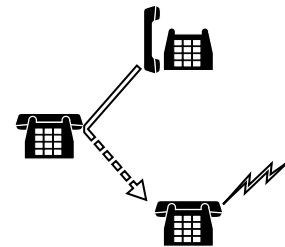

- **Related Feature References**

Direct Inward System Access (DISA), Uniform Call Distribution (UCD)

Intercom Calling

Allows an extension user to make a call to another extension.



- An extension number and a name can be assigned in programs [009] and [604]. If assigned, they will be shown on the display proprietary telephone during an intercom call.
- The DSS buttons permit a proprietary telephone user one-touch access to an extension. The DSS button can be assigned to a flexible CO button in the Proprietary Telephone Settings. The DSS buttons on the DSS console can also be used.
- An extension user can press the DSS buttons directly to make an intercom call without going off-hook. This can be enabled by program [126].



- **Required System Programming**

- [009] Extension Number Assignment
- [126] DSS Off-Hook Mode
- [604] Extension Name Setting

- **Operating Instructions References**

- 1.2 Proprietary Telephone Settings, “Customizing the Buttons on Your Telephone”, DSS (Direct Station Selection) Button
- 1.3 Making Calls, “Intercom Calling”
- 1.9 DSS Console Features, “Initial Settings”, Extension Number Assignment

Language Selection

The selected language in program [615] is shown on the LCD display of a proprietary telephone during operation and Proprietary Telephone Settings, but not used during System Programming. The selected language in program [806] is used for an SMDR printout.



- **Required System Programming**
 - [615] LCD Language Assignment
 - [806] SMDR Language Assignment

Limited Call Duration

The system disconnects 2 types of outside outgoing calls when a specific timer expires. One is a call with an external party. The other is an outside-to-outside (CO-to-CO) call using the Call Forwarding – to Outside (CO) Line, Call Transfer – to Outside (CO) Line, Unattended Conference feature, or the DISA feature. Limiting the time of the call can be assigned through System Programming.



- An alarm tone will be sent to both parties 15 seconds before the assigned time limit.



- **Required System Programming**
 - [205] Outside-to-Outside (CO-to-CO) Line Duration Time Limit
 - [212] Outside (CO) Line Duration Time Limit
 - [613] Outside (CO) Line Duration Time Limit Selection
- **Related Feature References**
 - Call Forwarding – to Outside (CO) Line, Call Transfer – to Outside (CO) Line, Conference (3-party), Direct Inward System Access (DISA)

Line Access Buttons

A proprietary telephone (PT) user must assign one of the following 3 types of CO buttons to flexible CO buttons in the Proprietary Telephone Settings. This allows making or receiving outside calls. The default setting for the flexible CO buttons (CO 1 – CO 6) are Single-CO (S-CO) buttons. CO 1 corresponds to outside (CO) line 1, CO 2 corresponds to outside (CO) line 2, etc.

<Group-CO (G-CO) Button>

Receiving or making outside calls is on an outside (CO) line group basis. The outside (CO) line group is assigned in program [404]. Any incoming call from any outside (CO) line in the outside (CO) line group arrives at the G-CO button. To make an outside call, the user can access an idle outside (CO) line in the group by simply pressing the assigned G-CO button.

<Single-CO (S-CO) Button>

Receiving or making outside calls is done using a specific outside (CO) line. An incoming call from the specific outside (CO) line arrives at the S-CO button. To make an outside call, the user can access the specific outside (CO) line by simply pressing the assigned S-CO button.

<Other-CO (O-CO) Button>

Outside (CO) lines, which are not assigned to an S-CO or G-CO button, can be assigned to a flexible CO button as the O-CO button. An incoming call on an outside (CO) lines arrives at the O-CO. To make an outside call, the user simply presses the assigned O-CO button.



- The same outside (CO) line group can be assigned to more than one G-CO button on the same PT.
- The same line can be assigned to an S-CO button and G-CO button. The S-CO button has priority.
- Immediate, delayed, no ringing or no incoming calls (disable) can be selected by programs [408] through [413] on an extension-outside (CO) line basis.
- A ringing pattern can be selected for each outside (CO) line by program [423].



• Required System Programming

- [400] Outside (CO) Line Connection Assignment
- [404] Outside (CO) Line Group Assignment
- [405]–[407] Flexible Outward Dialing Assignment — Day/Night/Lunch
- [408]–[410] Flexible Ringing Assignment — Day/Night/Lunch
- [411]–[413] Delayed Ringing Assignment — Day/Night/Lunch
- [423] Outside (CO) Line Ringing Pattern Selection

• Related Feature References

Ringing Pattern Selection, Outside Calling, Receiving Calls

• Operating Instructions Reference

1.2 Proprietary Telephone Settings, “Customizing the Buttons on Your Telephone”,
Line Access Buttons

Log-In/Log-Out

Allows an extension user to join (Log-In) or leave (Log-Out) a hunting, DISA ring or UCD group temporarily. Extensions in the log-out mode will not receive calls by Station Hunting, DISA or UCD but will receive other calls, not like the Do Not Disturb (DND) feature. The Log-In/Log-Out button can be assigned to a flexible button in the Proprietary Telephone Settings. The lighting patterns of the Log-In/Log-Out button on a proprietary telephone and status are as follows.

Off: Log-In mode
Red: Log-Out mode



- There should be at least one extension that is in the Log-In mode in a group.



- **Related Feature References**

Direct Inward System Access (DISA),
Extension Group,
Station Hunting, Uniform Call Distribution (UCD)

- **Operating Instructions References**

1.2 Proprietary Telephone Settings, “Customizing the Buttons on Your Telephone”,
Log-In/Log-Out Button
1.7 Useful Features, “Joining or Leaving a Call Distribution Group (Log-In/Log-Out)”

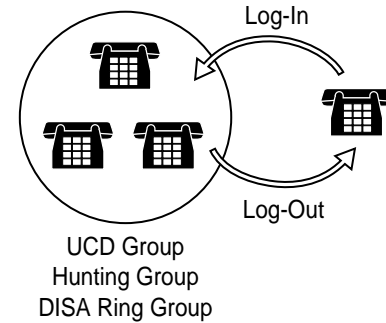

Message Waiting

Allows an extension user to notify the called extension of a message waiting when the called extension is busy or does not answer the call. Only a proprietary telephone user with a MESSAGE button can know there is a message waiting if the LED on the MESSAGE button lights red. Pressing the lit MESSAGE button can call back the called party. The messages which are stored in the mailbox of the Voice Processing System can also be heard by following the Voice Mail prompts after pressing the lit MESSAGE button (Voice Mail Integration).



- This feature is not available for a proprietary telephone which does not have a MESSAGE button, such as the KX-T7055.
- Canceling the message can be performed from the extension sending it or from the extension receiving it.
- Each extension can have a maximum of 8 simultaneous messages.
- Messages are always left at the original extension. They cannot be sent to a Call Forwarding or Station Hunting destination.



- **Operating Instructions References**

1.2 Proprietary Telephone Settings, “Customizing the Buttons on Your Telephone”,
Restoring the MESSAGE button
1.7 Useful Features, “Leaving a Message Notification (Message Waiting)”
1.7 Useful Features, “Voice Mail Integration for KX-TVP75/KX-TVP100”

Microphone Mute

Allows a proprietary telephone user to turn off the microphone for privacy.



- The user's voice will only be muted during a handsfree conversation. The user can hear the other party's voice during Microphone Mute.



- **Operating Instructions Reference**
1.5 During a Conversation, "Turning off the Microphone (Microphone Mute)"

Music on Hold / Background Music (BGM)

While an external party is on hold, music is automatically generated.



- Operations such as Call Hold and Call Transfer activate Music on Hold.
- A user-supplied external music source, such as a radio, must be connected to the system when "External" is selected in program [111]. One external music source can be connected to the system. The music source is used for Music on Hold and/or BGM.
- When "Tone" is selected in program [111], the cyclic tone is used only for Music on Hold and the external music source is used for BGM.



- **Connection Reference**
2.10 External Music Connection
- **Required System Programming**
[111] Hold Music Selection
- **Related Feature References**
Hold, Call Transfer – to Extension, Call Transfer – to Outside (CO) line, Uniform Call Distribution (UCD)
- **Operating Instructions Reference**
1.7 Useful Features, "Turning on the Background Music (BGM)"

One-Touch Dialing

Allows a proprietary telephone user one-touch access to a desired party or system feature. This is done by storing an extension number, telephone number or a feature number (up to 24 digits) in a One-Touch Dialing button. One-Touch Dialing buttons can be assigned to flexible buttons in the Proprietary Telephone Settings.



- An account code can be stored into a One-Touch Dialing button.
- A number consisting of 25 digits or more can be stored by dividing it and storing it in 2 One-Touch Dialing buttons.



- **Operating Instructions References**
 - 1.2 Proprietary Telephone Settings, “Customizing the Buttons on Your Telephone”
One-Touch Dialing button
 - 1.3 Making Calls, “Dialing by Simply Pressing a Button (One-Touch Dialing)”
 - 1.9 DSS Console Features, “Initial Settings”
 - 1.9 DSS Console Features, “One-Touch Dialing”
 - 1.9 DSS Console Features, “One-Touch Access for System Features”

Operator / Manager Extension

The system supports one operator. Any extension can be designated as an operator in program [008]. Extension jack 01 is the system manager extension. The extension assigned as an operator or manager has the ability to perform the following operations.

- Setting the Date and Time
- Canceling the Electronic Station Lockout
- Setting/Canceling the Remote Station Lock
- Setting/Canceling/Confirming the Timed Reminder (Wake-up Call) Remotely
- Recording and Playing the Outgoing Message
- Changing the Day/Night/Lunch Mode

The manager extension can also perform System Programming and the following operation.

- Setting the Extension Password



- **Required System Programming**
[008] Operator Assignment
- **Operating Instructions Reference**
1.8 Operator / Manager Service Features

Operator Call

Allows an extension user to call an operator within the system by dialing the feature number assigned in program [121]. One extension can be assigned as the operator in program [008].



- If an operator is not assigned, this feature is not available and a reorder tone will be heard.
- Every extension user can reach the operator just by dialing the operator call number (0 or 9) assigned in program [121] “Automatic Outside (CO) Line Access Number Selection”.



- **Required System Programming**
[008] Operator Assignment
[121] Automatic Outside (CO) Line Access Number Selection
- **Related Feature Reference**
Automatic Outside (CO) Line Access Number
- **Operating Instructions Reference**
1.3 Making Calls, “Calling an Operator (Operator Call)”

Outgoing Message (OGM)

Allows the extension assigned as an operator or manager to record up to 2 outgoing voice messages (maximum 30 seconds each). This message is played when a caller accesses the DISA or UCD feature. An optional OGM/FAX Detection Card is required to program the OGM.

The following are some examples of OGM and flow chart.

Case 1: Receives 2 calls at a time – OGM for DISA. (Do not want customers to be kept waiting.)

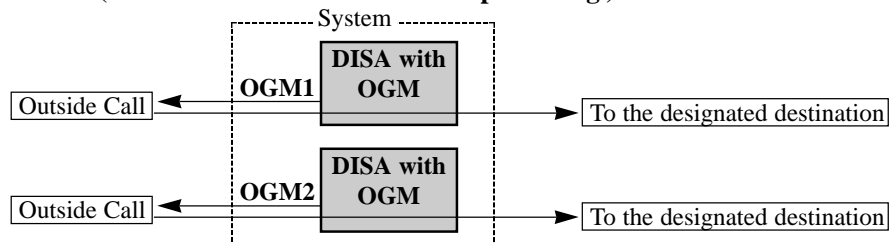

OGM1: “This is A company. For the sales division, press 1. For the service division, press 2. To call the operator, press 0.”

OGM2: Same as OGM 1

Required Settings: [502] “MODE1”
[414]-[416] “DISA1”

Case 2: Uses the OGM in the day, night and lunch modes – OGM for DISA.

(In the day mode)

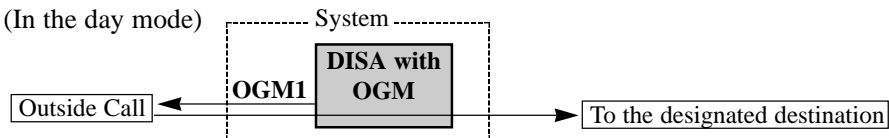

(In the night mode)

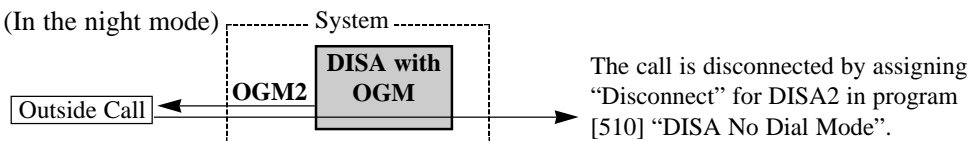

OGM1: “This is A company. For the sales division, press 1. For the service division, press 2. To call the operator, press 0.”

OGM2: “We are sorry but our office is closed for the day.”

Required Settings: [502] “MODE2”
[414]-[416] “DISA1” for OGM1, “DISA2” for OGM2

Case 3: Uses a different OGM for outside (CO) lines – OGM for DISA.

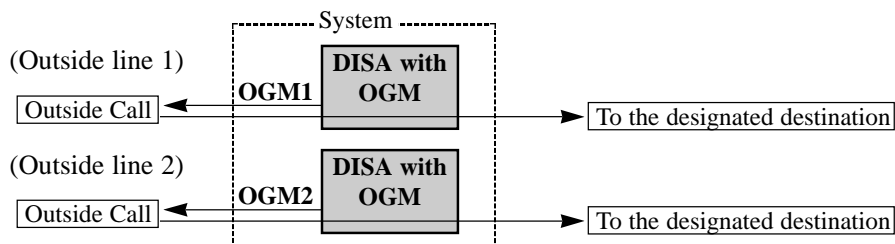

- OGM1: “This is A company. For the sales division, press 1. For the service division, press 2. To call the operator, press 0.”
- OGM2: “This is B company. To contact Mr. A, press 101. To contact Mr. B, press 102.”

Required Settings: [502] “MODE2”
 [414]-[416] “DISA1” for the A company outside (CO) line(s).
 “DISA2” for the B company outside (CO) line(s).

Case 4: Uses a different OGM when the line is busy – OGM for DISA.

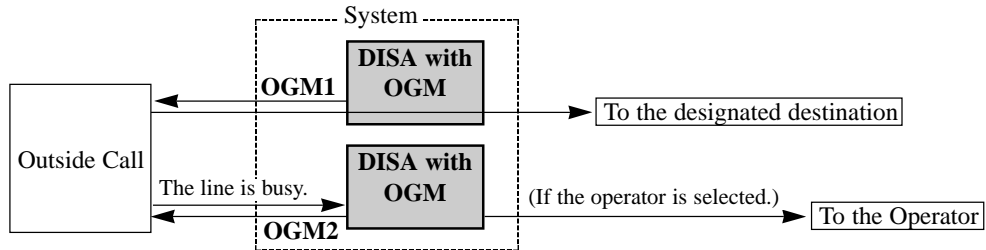

- OGM1: “This is A company. For the sales division, press 1. For the service division, press 2. To call the operator, press 0.”
- OGM2: “We are sorry. The line is currently busy. If you want to call the operator, press 0.”

Required Settings: [502] “MODE2”
 [414]-[416] “DISA1”
 [506] “DISA2”

Case 5: Distributes calls to the UCD group – OGM for UCD.

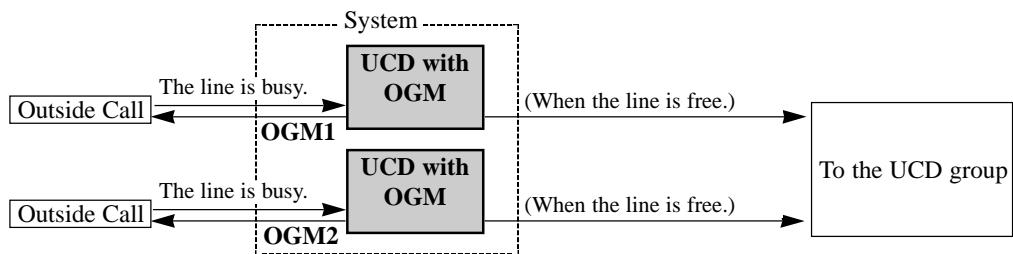

- OGM1: “We are sorry. The line is currently busy. Please hold.”
- OGM2: Same as OGM1

Required Settings: [502] “MODE3”
 [414]-[416] “UCD”

Case 6: Disconnects a call after the OGM – OGM for UCD.

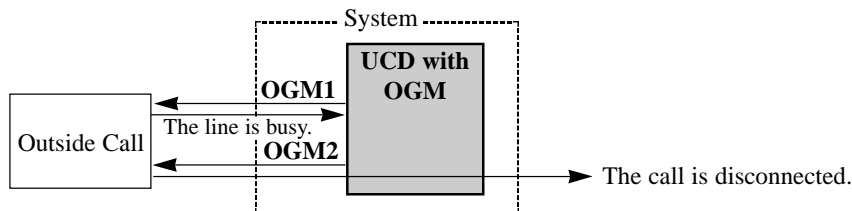

- OGM1: “We are sorry. The line is currently busy. Please hold.”
- OGM2: “We are sorry. The line is currently busy. Please call back later.”

Required Settings: [502] “MODE4”
 [414]-[416] “UCD”

**Case 7: Uses the DISA or UCD feature for outside (CO) lines
– OGM for DISA and UCD.**

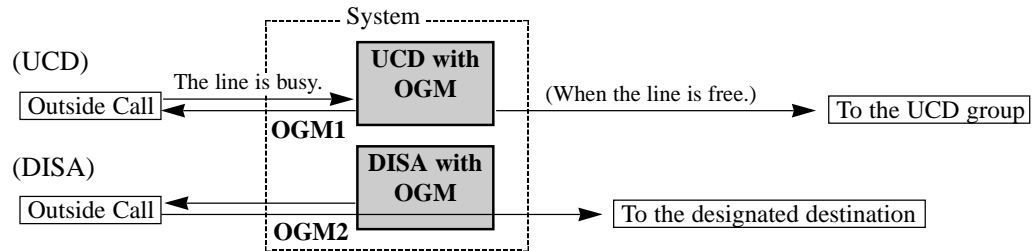

OGM1: “We are sorry. The line is currently busy. Please hold.” (UCD message)

OGM2: “This is A company. For the sales division, press 1. For the service division, press 2. To call the operator, press 0.” (DISA message)

Required Settings: [502] “MODE5”

[414]-[416] “DISA1” for outside (CO) line(s) which use the DISA feature

“UCD” for outside (CO) line(s) which use the UCD feature

Case 8: Uses the DISA feature when none of the extensions in the UCD group can answer a call – OGM for UCD.

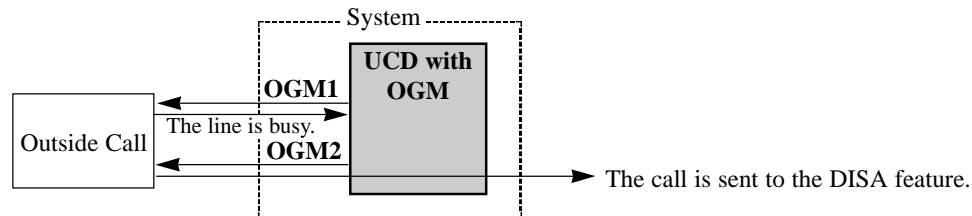

OGM1: “We are sorry. The line is currently busy. Please hold.”

OGM2: “This is A company. For the sales division, press 1. For the service division, press 2. To call the operator, press 0.”

Required Settings: [502] “MODE6”

[414]-[416] “UCD”

[523] “Intercept”



- An optional OGM/FAX Detection Card is required to program the OGM.



- **Connection Reference**

2.15 OGM/FAX Detection Card Installation

- **Required System Programming**

[414]-[416] Outside (CO) Line Mode — Day/Night/Lunch

[502] OGM Mode Selection

[506] DISA Busy Mode

[523] UCD Busy Mode

- **Related Feature References**

Direct Inward System Access (DISA), Uniform Call Distribution (UCD)

- **Operating Instructions Reference**

1.8 Operator / Manager Service Features, “Outgoing Message (OGM)”

Outside Calling

Allows an extension user to make a call to an external party by using one of the following line access methods.

<Automatic Line Access>

Allows an extension user to select an available outside (CO) line automatically from the assigned lines in program [419] by pressing the Automatic Line Access number (9 or 0). For a proprietary telephone, a Line Access Button assignment (S-CO, G-CO, O-CO) in the Proprietary Telephone Settings is required. If Idle Line Preference is set on the telephone in the Proprietary Telephone Settings, the user can access an idle line only by going off-hook.

<Individual Line Access>

Allows a proprietary telephone user to select the desired outside (CO) line by pressing the CO button assigned as the S-CO button. A Line Access Button assignment (S-CO) is required before use.

<Outside (CO) Line Group Access>

Allows an extension user to select an idle line within a designated outside (CO) line group. An outside (CO) line group is assigned in program [404]. To specify an outside (CO) line group, dial the feature number “8” and the desired outside (CO) line group number (1 through 6). A proprietary telephone user can also specify an outside (CO) line group by pressing a G-CO button. A Line Access Button assignment (G-CO) is required before use. If Idle Line Preference is set on the telephone in the Proprietary Telephone Settings, the user can access an idle line only by going off-hook.



- Each extension requires System Programming to access outside (CO) lines.
- After an outside (CO) line is seized, the system waits for the assigned time in program [206] before dialing.



• Required System Programming

- [206] Dialing Start Time
- [400] Outside (CO) Line Connection Assignment
- [404] Outside (CO) Line Group Assignment
- [405]–[407] Flexible Outward Dialing Assignment — Day/Night/Lunch
- [419] Automatic Designated Outside (CO) Line Access

• Related Feature References

- Automatic Outside (CO) Line Access Number
- Preferred Line Assignment — Outgoing, Line Access Buttons

• Operating Instructions References

- 1.2 Proprietary Telephone Settings, “Customizing Your Telephone Functions”, Preferred Line Assignment — Outgoing
- 1.2 Proprietary Telephone Settings, “Customizing the Buttons on Your Telephone”, Line Access Buttons
- 1.3 Making Calls, “Outside Calling”

Outside (CO) Line Ringing Selection

When an outside call is received at an extension, the user can select whether their extension will ring or not.



- Select “Enable” in programs [408]–[410].



- **Required System Programming**
[408]–[410] “Flexible Ringing Assignment — Day/Night/Lunch
- **Operating Instructions Reference**
1.2 Proprietary Telephone Settings, “Customizing Your Telephone Functions”,
Outside (CO) Line Ringing Selection

Paging

Allows an extension user to make a voice announcement to several people at the same time. The message is announced over the built-in speakers of proprietary telephones and/or the external pager. The paged person can answer the page (Answering a Page) from any extension within the system. The following types are available.

- All Extensions:** Makes a voice announcement to all extensions over the built-in speakers of proprietary telephones.
- Group:** Makes a voice announcement to the designated extension group over the built-in speakers of proprietary telephones. An extension group is assigned in program [600] “Extension Group Assignment”.
- External:** Makes a voice announcement over the external pager.
- All Extensions & External:** Makes a voice announcement to all extensions over the built-in speakers of proprietary telephones and the external pager.



- An extension user can also transfer a call after paging (Paging and Transfer). Also, pages can be denied (Paging Deny).
- An external pager (user-supplied) must be connected beforehand. One external pager can be connected to the system.
- A confirmation tone is sent to the extensions before the voice announcement or answering.
- A confirmation tone is sent to the external pager before the voice announcement. The tone to the external pager can be disabled in program [106].
- An extension which has set the Do Not Disturb (DND) or Paging Deny feature, or is in use cannot be paged.



- **Connection Reference**
2.9 External Pager (Paging Equipment) Connection
- **Required System Programming**
[106] External Paging Access Tone
- **Related Feature References**
Extension Group, Do Not Disturb (DND)
- **Operating Instructions Reference**
1.5 During a Conversation, “Paging”

Paralleled Telephone Connection

Any analog proprietary telephone can be connected in parallel with a single line device, such as a single line telephone, facsimile and data terminal.



- System Programming is required.



- **Connection Reference**
2.11 Paralleled Telephone Connection
- **Required System Programming**
[610] Paralleled Telephone Connection
- **Related Feature Reference**
Power Failure Transfer
- **Operating Instructions Reference**
1.7 Useful Features, “Parallel Connection of a Proprietary Telephone and Single Line Telephone (Paralleled Telephone Connection)”

Personal Speed Dialing

Allows an extension user to store up to 10 speed dialing numbers (0 through 9) with a maximum of 24 digits per number. An extension number, telephone number or feature number can be stored. For example, storing extension numbers for each room in a house can be useful. (1 = Living Room, 2 = Kitchen, etc.) To make a call, dial # and the number.



- Proprietary telephone users cannot use this feature if One-Touch Dialing buttons are assigned to PF buttons. If the user assign a personal speed dialing number, the number stored in the One-Touch Dialing button will be overwritten and vice versa. PF Buttons F1 through F10 correspond to the speed dialing numbers as follows.

F1 — 0	F6 — 5
F2 — 1	F7 — 6
F3 — 2	F8 — 7
F4 — 3	F9 — 8
F5 — 4	F10 — 9

- A rotary telephone user cannot use this feature.



- **Operating Instructions References**
1.3 Making Call, “Dialing with Personal Speed Dialing (Personal Speed Dialing)”

Pickup Dialing

Allows a single line telephone user to make an outgoing call by going off-hook, if the user has stored the telephone number (up to 32 digits) beforehand. This feature is also known as Hot Line.



- A rotary telephone cannot program this feature.
- The user can set and cancel this feature.
- If the feature is activated and the user goes off-hook, a dial tone will be generated for the delay time assigned in program [203] and then dialing will start. During the delay time, the user can dial another party overriding the Pickup Dialing function.



- **Required System Programming**
[203] Pickup Dial Delay Time
- **Operating Instructions Reference**
1.3 Making Call, “Dialing by Simply Going Off-Hook (Pickup Dialing)”

Polarity Reverse Detection

The circuit in the system can detect an outside (CO) line polarity reverse signal from the Central Office when trying to make an outside call. This detects the start (a called party goes off-hook) and end (the called party goes on-hook) of an outgoing outside call. The conversation time can be verified on the SMDR printout using this feature.

When an outside call is received, the circuit can also detect the polarity reverse signal before ringing.



- **Required System Programming**
[424] Reverse (Polarity) Circuit Assignment
- **Related Feature Reference**
Station Message Detail Recording (SMDR)

Power Failure Transfer

During a power failure, specific extension telephones are automatically connected to specific outside (CO) lines. This provides outside (CO) line conversations between the following extensions and outside (CO) lines.

Outside (CO) line 1 : extension jack 01

Outside (CO) line 4 : extension jack 09

A single line telephone (SLT) can work in case of a power failure. Connect an SLT to the above extension jack. For more information, refer to the Operating Instructions.



- All other conversations, except the above combinations, are disconnected during a power failure.
- Only an outside (CO) line can have a conversation. All other features do not work.
- We recommend connecting a single line telephone (SLT) in parallel at extension jacks 01 and 09, so that an SLT can be used during a power failure.



- **Connection Reference**
2.19 Auxiliary Connection for Power Failure Transfer
- **Related Feature Reference**
Paralleled Telephone Connection
- **Operating Instructions Reference**
1.7 Useful Features, “Power Failure Transfer”

Preferred Line Assignment — Incoming

A proprietary telephone user can select the method to answer incoming outside calls from the following 3 line preferences. System Programming and Proprietary Telephone Settings are required.

No Line Preference: When an incoming call is received, the extension user must go off-hook and then press the flashing CO button.

Prime Line Preference: When incoming calls are received at the same time, the user can receive the call on the preferred outside (CO) line by only going off-hook.

Ringing Line Preference: When an incoming call is received, the user can receive the call ringing at their telephone by going off-hook.



- A single line telephone can only set “Ringing Line Preference”.
- Line access button(s) (Single-CO, Other-CO or Group-CO) should be assigned to CO button(s) beforehand.



- **Required System Programming**
[408]–[410] Flexible Ringing Assignment — Day/Night/Lunch
[411]–[413] Delayed Ringing Assignment — Day/Night/Lunch
- **Related Feature Reference**
Line Access Buttons
- **Operating Instructions References**
1.2 Proprietary Telephone Settings, “Customizing Your Telephone Functions”, Preferred Line Assignment — Incoming
1.2 Proprietary Telephone Settings, “Customizing the Buttons on Your Telephone”, Line Access Buttons

Preferred Line Assignment — Outgoing

A proprietary telephone user can select a desired outgoing line preference to make outside calls from the following 3 line preferences. System Programming and Proprietary Telephone Settings are required.

- Idle Line Preference:** When the user goes off-hook, they are connected to an idle line. An idle line is automatically selected from the pre-assigned lines in program [419].
- Prime Line Preference:** When the user goes off-hook, they are connected to the pre-assigned line. Assign one prime line beforehand.
- No Line Preference:** No line is selected when the user goes off-hook. They must select a line to make a call.



- Line access button(s) (Single-CO, Other-CO or Group-CO) should be assigned to the CO button(s) beforehand.



- **Required System Programming**
 - [400] Outside (CO) Line Connection Assignment
 - [405]–[407] Flexible Outward Dialing Assignment — Day/Night/Lunch
 - [419] Automatic Designated Outside (CO) Line Access
- **Related Feature Reference**
 - Line Access Buttons
- **Operating Instructions References**
 - 1.2 Proprietary Telephone Settings, “Customizing Your Telephone Functions”, Preferred Line Assignment — Outgoing
 - 1.2 Proprietary Telephone Settings, “Customizing the Buttons on Your Telephone”, Line Access Buttons

Proprietary Telephone Setting Data Default Set

Allows a proprietary telephone user to reset the following Proprietary Telephone Settings to the default settings.

- Preferred Line Assignment — Outgoing
- Preferred Line Assignment — Incoming
- Outside (CO) Line Ringing Selection
- Intercom Alert Assignment
- Call Waiting Tone Selection



- **Operating Instructions Reference**
 - 1.2 Proprietary Telephone Settings, “Customizing Your Telephone Functions”, Proprietary Telephone Setting Data Default Set

Pulse to Tone Conversion

Allows an extension user to change the dialing mode from Pulse to Tone after entering a telephone number to access services, such as computer telephone services or Voice Mail, which require tones.



- This feature only works for outside (CO) lines which have set “Pulse Mode” or “Call Blocking Mode” in program [401].
- Changing from Tone to Pulse is not possible.



- **Required System Programming**
[401] Dial Mode
- **Operating Instructions Reference**
1.7 Useful Features, “Pulse to Tone Conversion”

Receiving Calls

Allows an extension user to receive an intercom or outside call by going off-hook. A proprietary telephone user can also receive a call by pressing the rapid flashing CO or INTERCOM button, and talk (handsfree mode) if the telephone has the SP-PHONE button.



- A proprietary telephone user can select the Line Preference for incoming outside calls. See “Preferred Line Assignment — Incoming” in this section.



- **Required System Programming**
[408]–[410] “Flexible Ringing Assignment — Day/Night/Lunch”
[411]–[413] “Delayed Ringing Assignment — Day/Night/Lunch”
- **Related Feature Reference**
Preferred Line Assignment — Incoming
- **Operating Instructions Reference**
1.4 Receiving Calls, “Receiving Calls”

Redial

<Automatic Redial>

Allows a proprietary telephone user to redial the last number dialed, and saved number by the Saved Number Redial feature automatically. This is done by pressing the SP-PHONE or MONITOR button and the corresponding button. Redial will be repeated automatically the assigned number of times in program [113] until the called party answers. The interval time between Automatic Redial is programmed in [114]. If another operation is performed during Automatic Redial, this function will be canceled. This feature is not available for the KX-T7055.

<Last Number Redial>

Every extension automatically saves the last telephone number dialed so that the extension user can make a call to the same party later using a simple operation.

<Saved Number Redial>

Allows a proprietary telephone user to save the current external telephone number in the SAVE button during a conversation, so that the extension user can redial the same party later using a simple operation. The saved number can be redialed until another number is stored. A flexible button can be assigned as the SAVE button in the Proprietary Telephone Settings.



- **Required System Programming**
 - [113] Automatic Redial Repeat
 - [114] Automatic Redial Interval Time
- **Operating Instructions References**
 - 1.2 Proprietary Telephone Settings, “Customizing the Buttons on Your Telephone”, SAVE button
 - 1.3 Making Calls, “Redialing Automatically (Automatic Redial)”
 - 1.3 Making Calls, “Redialing the Last Number Dialed (Last Number Redial)”
 - 1.3 Making Calls, “Redialing the Saved Number (Saved Number Redial)”

Ringling Pattern Selection

A ringing pattern can be selected depending on the type of call such as an outside call, intercom call and doorphone call. Available ringing patterns are as follows:

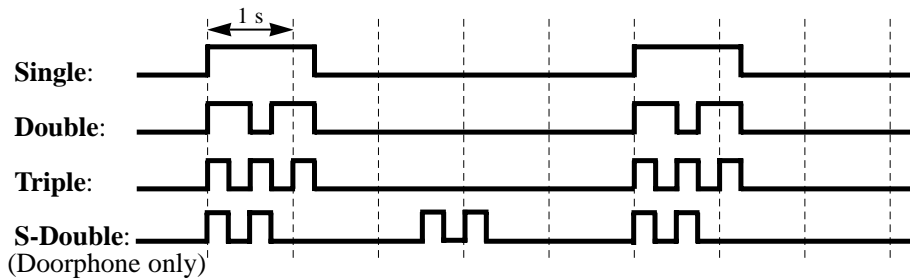

- Private calls can be distinguished from business calls by assigning different ringing per outside (CO) line. Moreover, by assigning different ringing, intercom calls and doorphone calls can be distinguished from other calls. Therefore, careful attention should be applied to all ringing assignments.



- **Required System Programming**
 - [115] Extension Ringing Pattern Selection
 - [423] Outside (CO) Line Ringing Pattern Selection
 - [706] Doorphone Ringing/Tone Pattern Selection
- **Related Feature Reference**
 - Outside (CO) Line Ringing Selection

Room Monitor

Allows a proprietary telephone user to monitor a room or the front door through another proprietary telephone or doorphone without them knowing. The access tone will not be sent to the monitored proprietary telephone when monitoring starts.



- The extensions that can be monitored must be programmed in [612] before operation when using a proprietary telephone.
- If a doorphone is used as a room monitor, the access tone will be heard when monitoring starts as the default setting. The tone can be disabled in program [707].
- This feature is not available for KX-T7050, KX-T7055 and KX-T7350.
- A single line telephone with a MUTE button can be used for monitoring.



- **Required System Programming**
 - [612] Room Monitor Assignment
 - [707] Doorphone Access Tone Selection
- **Related Feature Reference**
 - Doorphone Call
- **Operating Instructions Reference**
 - 1.7 Useful Features, “Room Monitor”

Secret Dialing

Allows a proprietary telephone user to conceal all or part(s) of a System Speed Dialing number assigned in program [001] or One-Touch Dialing number assigned to a flexible button in the Proprietary Telephone Settings which normally appear on the display.



- When storing a number, press the INTERCOM button at the beginning and the end of the numbers to be concealed.
- One or more parts of a telephone number can be concealed.
- Printing out the concealed number on a SMDR can be assigned in program [803].



- **Required System Programming**
 - [001] System Speed Dialing Entry
 - [803] Secret Speed Dialing/One-Touch Dialing Printing
- **Related Feature References**
 - One-Touch Dialing, System Speed Dialing
- **Operating Instructions References**
 - 1.2 Proprietary Telephone Settings, “Customizing the Buttons on Your Telephone”, One-Touch Dialing Button
 - 1.7 Useful Features, “Secret Dialing”

Self-Extension Number Confirmation ***(KX-T7330/KX-T7030/KX-T7130/KX-T7033 only)***

Allows a display proprietary telephone user to confirm their jack and extension number using a simple operation.



- **Operating Instructions Reference**
1.7 Useful Features, “Self-Extension Number Confirmation (KX-T7330/KX-T7030/KX-T7130/KX-T7033 only)”

Station Feature Clear

Allows an extension user to reset the following station features to the default settings.

- Absent Message Capability
- Automatic Callback Busy (Camp-On)
- Background Music (BGM)
- Call Forwarding
- Call Pickup Deny
- Call Waiting
- Data Line Security
- Do Not Disturb (DND)
- Executive Busy Override Deny
- Log-In/Log-Out
- Message Waiting – (All messages will be erased.)
- Pickup Dialing – (The stored telephone number will be erased.)
- Paging Deny
- Room Monitor
- Timed Reminder
- Voice Mail Integration



- **Operating Instructions Reference**
1.7 Useful Features, “Canceling the Feature Settings (Station Feature Clear)”

Station Hunting

If a called extension is busy, Station Hunting redirects the incoming call to an idle extension in an extension group in numerical order. Idle extensions are automatically hunted according to programming. The following 2 hunting types are available.

Circular hunting: The extensions are hunted one time in numerical order. If all extensions are busy, a busy tone will be heard.

Terminate hunting: The extensions are hunted until the extension which has the highest jack number in the group is reached. If all higher order numbers are busy, the search will end and a busy tone will be heard.



- One hunting type can be selected for each extension group.
- To leave the hunting group temporarily, use the Log-Out feature. To rejoin, use the Log-In feature.
- If the called extension has set Do Not Disturb (DND), Call Forwarding or Log-Out, Station Hunting will skip the extension. However, Station Hunting will not skip the extension which receives the call first, even if it has set Do Not Disturb (DND) or Call Forwarding.



- **Required System Programming**
 - [100] Hunting Group Set
 - [101] Hunting Type
 - [600] Extension Group Assignment
- **Related Feature References**
 - Call Forwarding
 - Do Not Disturb (DND)
 - Extension Group
 - Log-In/Log-Out

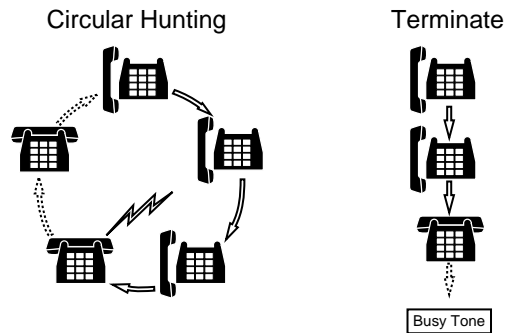

Station Lock

<Electronic Station Lockout>

Allows an extension user to lock their station so that other users cannot make outside calls until it is unlocked. Any 4-digit code can be used to lock and unlock an extension.



<Electronic Station Lockout – CANCEL ALL>

The operator and manager can cancel Electronic Station Lockout of all extensions at one time.

<Remote Station Lock Control>

The operator and manager are given the privilege of controlling Electronic Station Lockout at any station by using the DSS console. The operator and manager can see the status of each extension, locked or unlocked, by the pre-assigned DSS button LED on the DSS console. For example, this feature is useful for a small hotel or motel when guests are checked out.



- The Remote Station Lock Control overrides the Electronic Station Lockout. If the operator or manager sets Remote Station Lock on an extension that has already been locked by the extension user, the user cannot unlock it.
- A toll restriction class can be assigned to an extension which has set the Electronic Station Lockout and Remote Station Lock Control features in program [312] “Toll Restriction – Station Lock Boundary Class”. Certain types of outgoing outside calls are allowed depending on the assigned toll restriction class.



• Operating Instructions References

- 1.6 Before Leaving Your Desk, “Locking Your Telephone (Electronic Station Lockout)”
- 1.8 Operator / Manager Service Features, “Electronic Station Lockout – CANCEL ALL”
- 1.8 Operator / Manager Service Features, “Remote Station Lock”
- 1.9 DSS Console Features “Initial Settings”, Station Lock Button Assignment (Operator/Manager only)

Station Message Detail Recording (SMDR)

Station Message Detail Recording (SMDR) automatically prints out detailed call information of outside calls. A printer connected to the Serial Interface (RS-232C) port can be used to print incoming and outgoing outside calls, as well as print a hard copy of System Programming. To print out the record of System Programming items that have been assigned, use program [804] "System Data Dump". To print the call records, use program [802] "Incoming/ Outgoing Call Selection for Printing", which prints out the following records.

- A record of all outgoing outside calls or outgoing toll calls
- A record of all incoming outside calls

An example of a printed call record:

Date	Time	Ext.	CO	Dial number	Duration	Code
12/31/98	12:52PM	103	05	12345678901234567890123456789012	00:00'16
12/31/98	12:53PM	103	02	< incoming >	00:01'43
12/31/98	*12:54PM	101	02	< incoming >	00:07'48
12/31/98	1:04PM	103	06	092...1438	00:00'06	4536
12/31/98	1:04PM	102	05	< DISA incoming >	00:00'09 0
12/31/98	1:05PM	103	01	< DISA incoming >	00:00'08 0
12/31/98	1:06PM	103	01	092123456789	00:00'08
12/31/98	1:06PM	C-05	02	0921234567	00:00'17 2
12/31/98	1:07PM	103	01	0921234567	00:11'00	..13
12/31/98	2:15PM	103	01	0921234567	00:11'00	.101
12/31/98	2:26PM	103	01	F/0927654321	00:03'00
12/31/98	2:27PM	116	05	9=0924567123	00:13'55
12/31/98	3:25PM		02	< UCD Waiting >	00:11'48
.
.
(1)	(2)	(3)	(4)	(5)	(6)	(7)

Example of the SMDR printout format:

Explanation

- (1) Date : shows the date of the call as Month/Day/Year.
- (2) Time : shows the time the call was started as Hour: Minute/AM or PM.
"*" indicates a transferred call.
- (3) Ext. : shows the extension number, etc. that engaged in the call. "C-xx" indicates an outside-to-outside (CO-to-CO) call via the DISA feature. The outside (CO) line which receives a DISA call is shown as xx.
- (4) CO : shows the outside (CO) line number used for the call.
- (5) Dial number
 - Outgoing call:** Shows the called party's telephone number (maximum 32 digits). Valid digits are 0 through 9, #, * and P (if the PAUSE button was pressed).
 - Received call:** Shows <incoming>. An incoming call via the DISA feature is shown as <DISA incoming>, via the DIL feature is shown as <DIL incoming>.

UCD waiting call: Shows <UCD waiting> for an incoming call via the UCD feature. When the “UCD waiting call” is answered, it becomes a “Received call” and a new record is started.

- (6) Duration : shows the duration of the call or the UCD call waiting time in Hours/Minutes/Seconds.
- (7) Code: shows the account code appended to the call, account code index number (e.g.: 13), the extension number which uses the Walking COS feature (e.g.: 101) or DISA security code status (e.g.: 0). Code “0” indicates a DISA incoming call without a DISA security code. Codes “1 to 4” indicate a DISA incoming call with DISA security code 01 to 04 respectively. DISA security codes are never printed out by SMDR.



- This system can store information of up to 64 calls.
- This data is not deleted even when the system is reset.
- If FLASH is manually sent out during a conversation to make another call without hanging up, etc., a call record will be printed and a new record started. “F/” will be printed at the beginning of the dial number on the new record.
- When a host PBX code is entered, “=” will be printed between the code and dialed number.
- The language used for an SMDR printout can be selected in program [806].



- **Connection Reference**
 - 2.13 Printer and PC Connection
- **Required System Programming**
 - [000] Date and Time Setting
 - [204] Call Duration Count Start Time
 - [800] SMDR RS-232C Communication Parameters
 - [801] SMDR Parameter
 - [802] Incoming/Outgoing Call Selection for Printing
 - [803] Secret Speed Dialing/One-Touch Dialing Printing
 - [804] System Data Dump
 - [805] SMDR Account Code Selection
 - [806] SMDR Language Assignment
- **Related Feature Reference**
 - Language Selection

System Data Default Set

This system can re-initialize the system-programmed data. If all the programmed data is cleared, the system will reset using the default settings by program [999].



- The default setting for each programming item is listed in Section 5.1, Default Values.



- **Required System Programming**
 - [999] System Data Clear
- **Installation Reference**
 - 2.24 System Data Clear

System Speed Dialing

The system supports 100 System Speed Dial numbers (up to 32 digits) assigned in program [001] that are available to all extension users. A System Speed Dial number is dialed out using a simple operation.

Each System Speed Dial number can be assigned a name in program [011]. The assigned name will be displayed when making a call by using the System Speed Dialing feature. It will also be displayed when an external caller's telephone number matches one of System Speed Dialing numbers and a Telephone Company does not provide the caller's name.



- Toll Restriction for System Speed Dialing can be assigned by program [301].
- A rotary telephone user cannot use this feature.



- **Required System Programming**

- [001] System Speed Dialing Entry
- [011] System Speed Dialing Name Setting
- [301] Toll Restriction – System Speed Dialing Boundary Class

- **Related Feature**

Toll Restriction for System Speed Dialing

- **Operating Instructions for the Caller ID Card References**

Section 1.2, System Features

Caller ID

- **Operating Instructions Reference**

1.3 Making Calls, “Dialing with System Speed Dialing (System Speed Dialing)”

Timed Reminder

<Timed Reminder>

Allows an extension user to generate an alarm tone at a preset time as a wake-up alarm or a reminder. The user can set this to be activated once or everyday.

<Timed Reminder, Remote (Wake-Up Call)>

The operator or manager can remotely set, cancel and confirm the Timed Reminder of the desired extension. For example, this is useful for a small hotel or motel to set an extension in a guest room as a wake-up call, or set an extension in a child's room by a mother.



- **Operating Instructions References**

1.7 Useful Features, “Alarm Setting (Timed Reminder)”

1.8 Operator / Manager Service Features, “Timed Reminder, Remote (Wake-Up Call)”

Time (Day/Night/Lunch) Service

The system supports the day, night and lunch operation modes. The system operation for making and receiving calls can be different for the day, night and lunch modes. The system operation for toll restriction can be arranged to prevent unauthorized toll calls for each mode. Time service can be set automatically or manually by program [006].

Changing the Day/Night/Lunch Modes

The day, night and lunch modes can be changed either automatically at an assigned time in program [007] or manually by the operator or manager at any desired time.



- The lunch mode interrupts the day or night mode. After the lunch mode is finished, the day or night mode starts again.
- If the lunch mode is set using feature number “783#” in the automatic mode, the mode can only be canceled by using feature number “780#”. This can be useful during holidays. The day and night modes are automatically changed at the programmed time in [007] even if feature number “780#” is not entered. These operations can only be done by an operator or manager.
- The operator and manager can see the status of the mode (day, night or lunch) by the pre-assigned DSS buttons’ LED on the DSS console. Time service can be changed easily by pressing the pre-assigned DSS buttons.
- The following programming items will be affected by the time service.
 - [405]-[407] Flexible Outward Dialing Assignment
 - [408]-[410] Flexible Ringing Assignment
 - [411]-[413] Delayed Ringing Assignment
 - [414]-[416] Outside (CO) Line Mode
 - [601]-[603] TRS – Class of Service Assignment
 - [700]-[702] Doorphone Ringing Assignment
 - [703]-[705] Door Opener Assignment

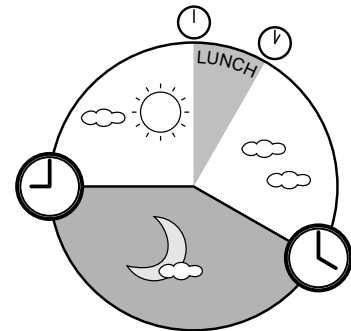

- **Required System Programming**
 - [006] Time (Day/Night/Lunch) Service Changing Mode
 - [007] Time (Day/Night/Lunch) Service Start Time
- **Operating Instructions References**
 - 1.8 Operator / Manager Service Features, “Time (Day/Night/Lunch) Service Setting”
 - 1.9 DSS Console Features, “Initial Settings”, Day, Night and Lunch Buttons Assignment

Toll Restriction

Toll Restriction is a system programmable feature that can prohibit certain extension users from making unauthorized toll calls.

Every extension is programmed to belong to one of 5 classes of service (COS). Each COS is programmed to have a toll restriction class for day mode, night mode and lunch mode.

There are 5 toll restriction COS numbers available. Toll restriction COS number 1 is the highest class and the COS number 5 is the lowest. That is, COS number 1 allows all toll calls. COS numbers 2 through 5 are used to restrict calls by combining pre-programmed deny and exception codes shown in the table on the next page.

Denied Codes

An outgoing outside call made by an extension with a toll restriction COS number between 2 and 5 is first checked against the assigned denied codes in program [302]-[305].

If the first digits of the dialed number (not including the line access code) are not found in the class, the call can be made. Each class can store up to 20 denied codes, each consisting of 11 digits.

Exception Codes

These codes are used to override a programmed denied code. A call denied by the denied codes is checked against the selected exception codes assigned in program [306]. If a match is found, the call can be made.

Up to 80 exception codes, each consisting of 11 digits, can be stored. The available number of codes depends on the COS number.



- Emergency numbers, such as the police or fire station, should be stored in program [309] "Emergency Dial Number Set" so that they are excepted from toll restriction.
- If a stored Host PBX access code in program [403] "Host PBX Access Codes" or a stored carrier code in program [300] "Carrier Excepted Code Assignment" is found in the dialed number, the subsequent telephone numbers will be checked for toll restriction.
- The interdigit timer assigned in program [208] "Interdigit Time" applies until the toll restriction check is completed. When the timer expires, an outside outgoing call will be disconnected while dialing, if "Enable" was selected in program [211] "No Dial Disconnection".
- The toll restriction class for a station locked extension can be assigned in program [312] "Toll Restriction – Station Lock Boundary Class" so that even a station locked extension can make a local call, etc.
- It is programmable whether the "*" or "#" the user dials is to be checked or not on the Toll Restriction code in program [125] "Toll Restriction Check for * and #". This is useful to prevent unauthorized calls which could be possible through certain Central Office exchange systems.



Required System Programming

- [301] Toll Restriction – System Speed Dialing Boundary Class
- [302]-[305] Toll Restriction – Classes 2 through 5 Denied Codes
- [306] Toll Restriction – Exception Codes
- [601]-[603] TRS – Class of Service Assignment – Day/Night/Lunch

Related Feature References

- Emergency Call, Toll Restriction for System Speed Dialing
- Toll Restriction Override by Account Codes
- Toll Restriction – Station Lock Boundary Class

Combination of denied codes and exception codes

COS No.	Denied Calls	Excepted Calls
1	No restriction.	No restriction.
2	20 denied codes programmed in [302].	80 exception codes (code numbers 01-80) programmed in [306].
3	20 denied codes programmed in [302] plus 20 denied codes programmed in [303].	60 exception codes (code numbers 01-60) programmed in [306].
4	20 denied codes programmed in [302] plus 20 denied codes programmed in [303] plus 20 denied codes programmed in [304].	40 exception codes (code numbers 01-40) programmed in [306].
5	20 denied codes programmed in [302] plus 20 denied codes programmed in [303] plus 20 denied codes programmed in [304] plus 20 denied codes programmed in [305].	20 exception codes (code numbers 01-20) programmed in [306].

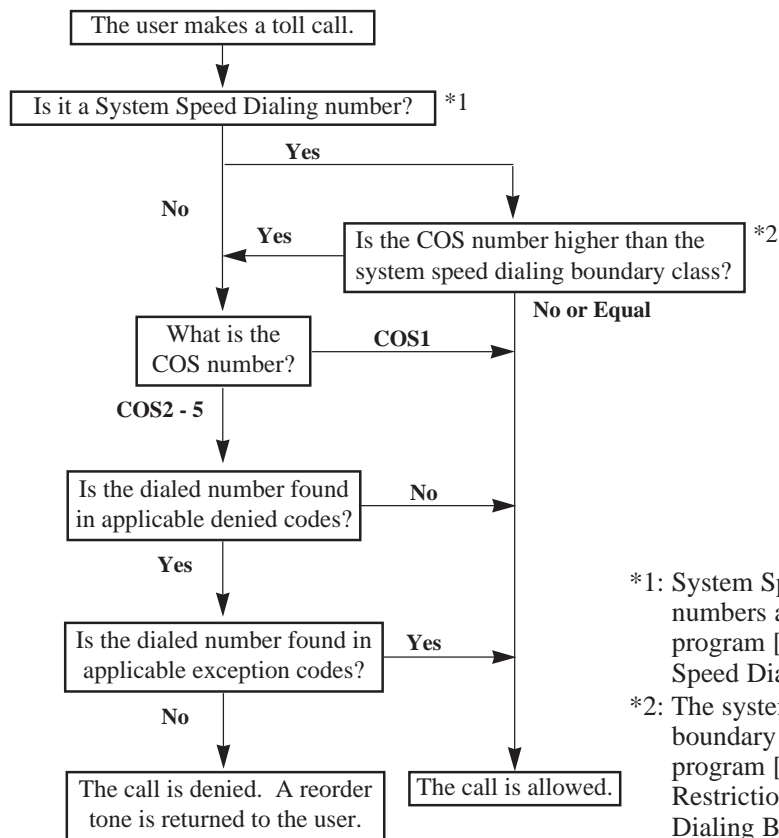
Flow chart of Toll Restriction

Toll Restriction for System Speed Dialing

Calls originated by System Speed Dialing are restricted depending on the combination of the System Speed Dialing Boundary Class assigned in program [301] and the class of service (COS) assigned to each extension as follows.

COS No.	System Speed Dialing Boundary Class				
	1	2	3	4	5
1	A	A	A	A	A
2	C	A	A	A	A
3	C	C	A	A	A
4	C	C	C	A	A
5	C	C	C	C	A

<Example>

—If the boundary is set to COS number 2, The system will allow system speed dialing for COS numbers 1 and 2, but check COS numbers 3, 4 and 5 according to toll restriction.

A: allowed **C:** checked



- **Required System Programming**
[301] Toll Restriction – System Speed Dialing Boundary Class
- **Related Feature Reference**
Toll Restriction

Toll Restriction Override by Account Codes

Allows an extension user to override toll restriction temporarily to make a toll call from a toll-restricted extension. The user can carry out this feature by entering one of the account codes programmed in [310] before dialing the telephone number. The user can make a toll call with the COS number 2.



- The account code “Verify–Toll” mode at an extension permits users to override their toll restrictions.
- This feature can be used on extensions assigned to toll restriction COS numbers 3 through 5. The COS numbers 1 and 2 will not be changed.
- If the user does not enter an account code or enters an invalid one, a regular toll restriction check is done.
- When a user makes a call using this feature, it will appear on the SMDR printout with either the entered 4-digit account code or the 2-digit index of the entered account code. This selection is set in program [805].
- Users can also override toll restriction of another extension by using the Walking COS feature.

Flow chart of TRS Override

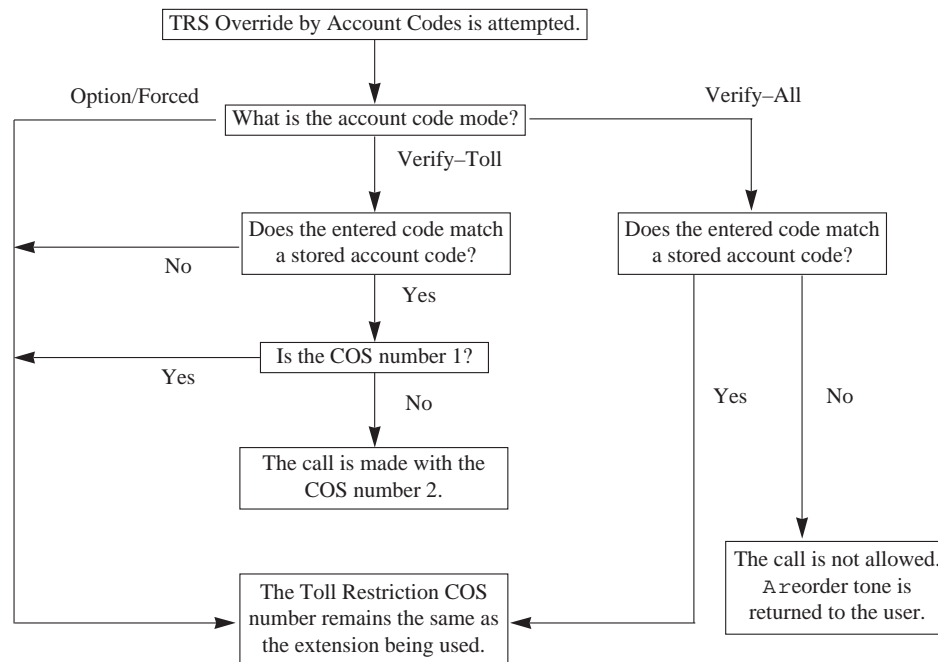

Required System Programming

- [310] Account Codes
- [605] Account Code Entry Mode
- [805] SMDR Account Code Selection

Related Feature References

- Account Code Entry, Station Message Detail Recording (SMDR), Toll Restriction, Walking COS

Toll Restriction — Station Lock Boundary Class

Allows assigning a toll restriction class for extensions where the Electronic Station Lockout or Remote Station Lock feature has been set.

An extension user usually cannot make an outside call at a locked extension, however if a toll restriction class is assigned in program [312], the user can make an outside call at the locked extension.



- The higher toll restriction class number will take precedence. For example, if toll restriction COS number 3 is assigned to an extension and the station lock boundary class is 4, the extension user is allowed to make a call with toll restriction COS number 4.



- **Required System Program Address**
[312] Toll Restriction – Station Lock Boundary Class
- **Related Feature References**
Station Lock, Toll Restriction

Uniform Call Distribution (UCD)

Distributes incoming calls to one specific extension group called a UCD group assigned in program [520]. Calls to the UCD group hunt for an idle extension in numerical order. The UCD feature is particularly helpful when a certain extension receives a high volume of calls compared with other extensions.



- An optional OGM/FAX Detection Card is required to perform the UCD feature.
- The Log-In or Log-Out status can be set on an extension basis. There should be at least one extension that is in Log -In status in the UCD group.
- An extension which sets the Call Forwarding–All, –Busy or No Answer, or the Do Not Disturb (DND) feature is skipped during circular calling.
- When all extensions in the UCD group are busy, a busy message is heard and then Music on Hold is activated. If any extension in the UCD group is not available within the programmed time period, then (1) an OGM will be heard and the call is disconnected, or (2) the call will be sent to pre-programmed extension(s) in [408]-[410]. System Programming is required for this operation. Refer to the “Flow chart of possible cases and results for UCD calls”.



- **Connection Reference**
2.15 OGM/FAX Detection Card Installation
- **Required System Programming**
[111] Hold Music Selection
[408]-[410] Flexible Ringing Assignment – Day/Night/Lunch
[414]-[416] Outside (CO) Line Mode — Day/Night/Lunch
[502] OGM Mode Selection
[513] Cyclic Tone Detection
[520] UCD Group

- [521] UCD Busy Waiting Time
- [522] UCD OGM Message Interval Time
- [523] UCD Busy Mode
- [524] UCD Intercept Mode
- [525] UCD Ringing Time before Intercept
- [526] UCD Ringing Time after Intercept
- [600] Extension Group Assignment

• **Related Feature References**

Call Forwarding, Do Not Disturb (DND), Extension Group, Log-In/Log-Out

Outline of a UCD

- (1) When a number of calls have arrived at the UCD group, the first call arrives at extension A first.
- (2) When the first call arrives at extension A, the second call arrives at extension B.

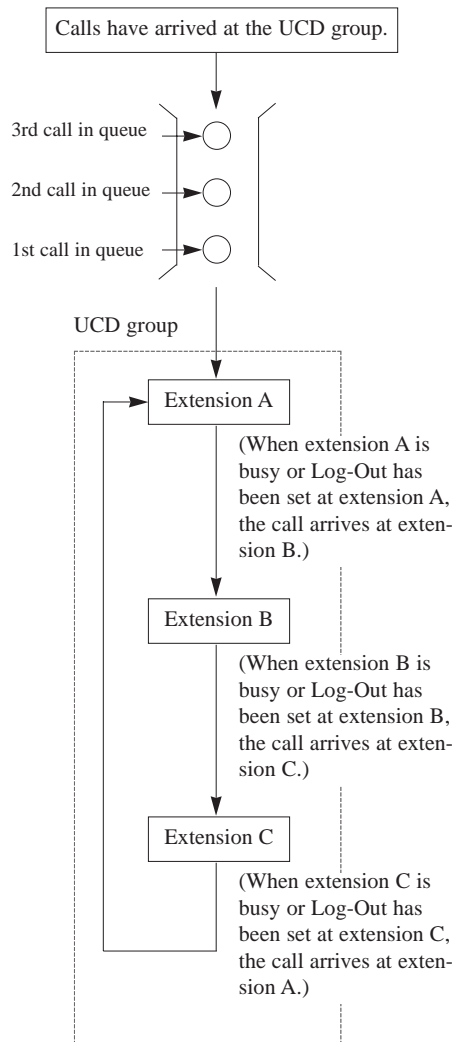

- (2) When the first call arrives at extension A, the second call arrives at extension B.

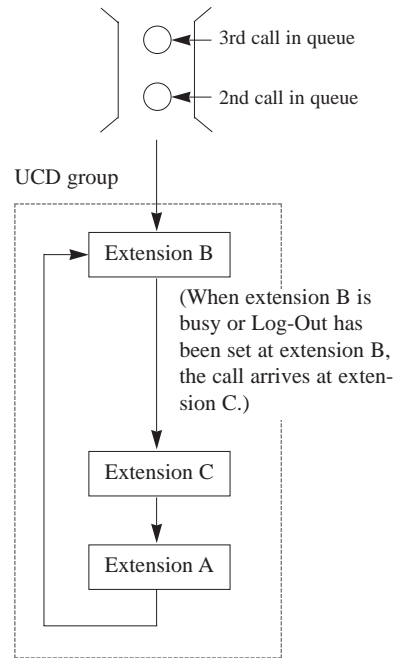

- (3) When the second call arrives at extension B, the third call will arrive at extension C.

Flow chart of possible cases and results for UCD calls

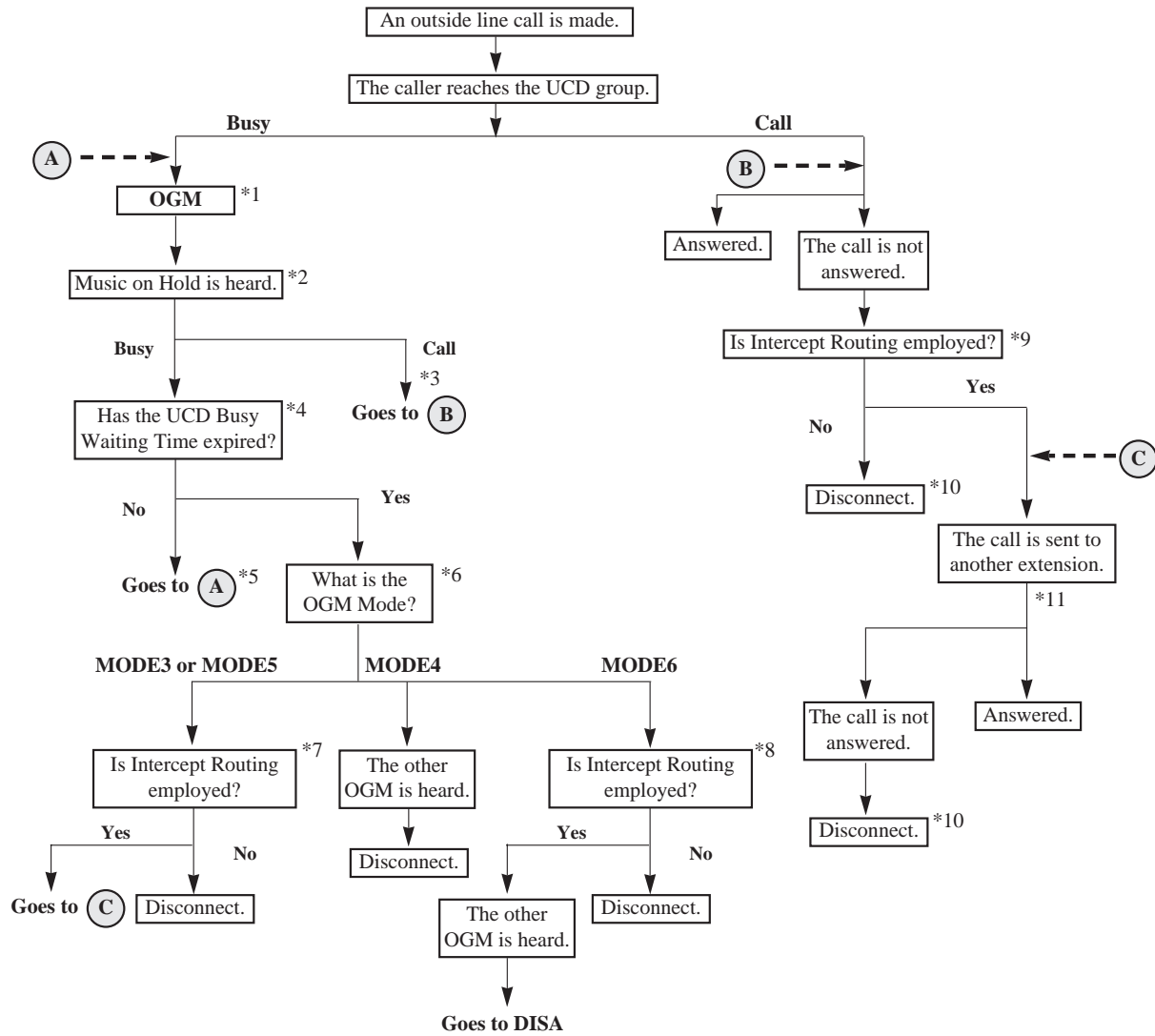

- *1: An OGM is sent to the caller.
When the system detects a cyclic tone or CPC signal while the OGM is being sent, the call is disconnected.
- *2: Music on hold is selected in program [111] as follows.
- **External** – Uses an external music source, such as a radio.
 - **Internal** – Uses the internal music source equipped with the system.
 - **Tone** – Uses the cyclic tone equipped with the system.
- *3: When an extension in the UCD group is available.
- *4: The system holds the call until the assigned time in program [521] expires.
- *5: OGM repeats the assigned time intervals in program [522] within the assigned time in program [521].
- *6: The OGM Mode is selected in program [502].
- *7: The system treats the call according to program [523] as follows when the assigned time in [521] expires.
- **Disconnect** – The call is disconnected.
 - **Intercept** – The call is sent to the extensions programmed in [408]-[410].
- *8: The system treats the call according to program [523] as follows when the assigned time in [521] expires.
- **Disconnect** – The call is disconnected.
 - **Intercept** – The other OGM leads the caller to the DISA feature (☞ “Direct Inward System Access (DISA)” in this section).
- *9: The system treats the call according to program [524] as follows when the assigned time in [525] expires.
- **Disconnect** – The call is disconnected.
 - **Intercept** – The call is sent to the extensions programmed in [408]-[410].
- *10: If the caller did not hear an OGM, the call will not be disconnected until the caller goes on-hook.
- *11: The UCD Ring Timer after Intercept starts. The destination telephone(s) will ring for the time programmed in program [526]. If the call is not answered during the programmed time, the call will be disconnected.

Voice Mail Integration for KX-TVP75/KX-TVP100

This system supports Voice Processing System (VPS) equipment (Panasonic KX-TVP75/ KX-TVP100) by sending DTMF tones described in program [103]. The DTMF tones sent to a VPS indicate the state of a call (busy, answered, ringing, disconnected, etc.). The DTMF tones also inform a VPS of the destination of a call transferred to the VPS by the Call Forwarding or DISA Intercept Routing – No Answer feature. Up to 4 VPSs can be connected to the extension jacks as extensions in the system.

System Explanation

1. Voice Mail Service

1.1 Call Forwarding to VM

If an extension user sets Call Forwarding (C. FWD) whose destination is the VPS, an incoming call is forwarded to the VPS. The system sends the VPS the extension mailbox number at that time. Therefore, the calling party can leave their message in the mailbox of the desired extension without having to know the mailbox number.

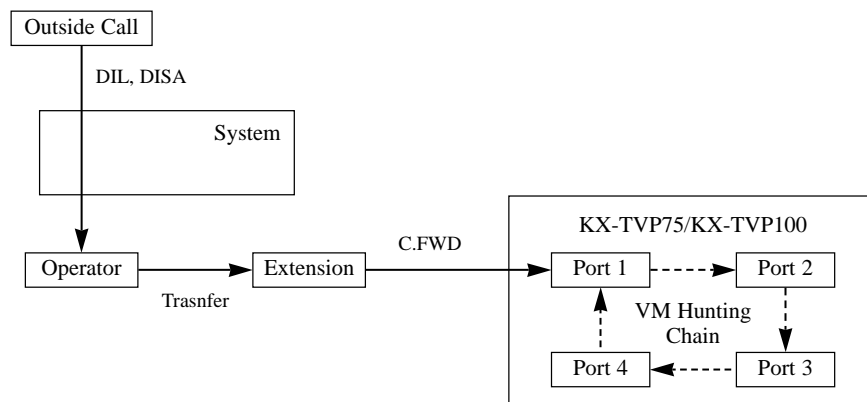
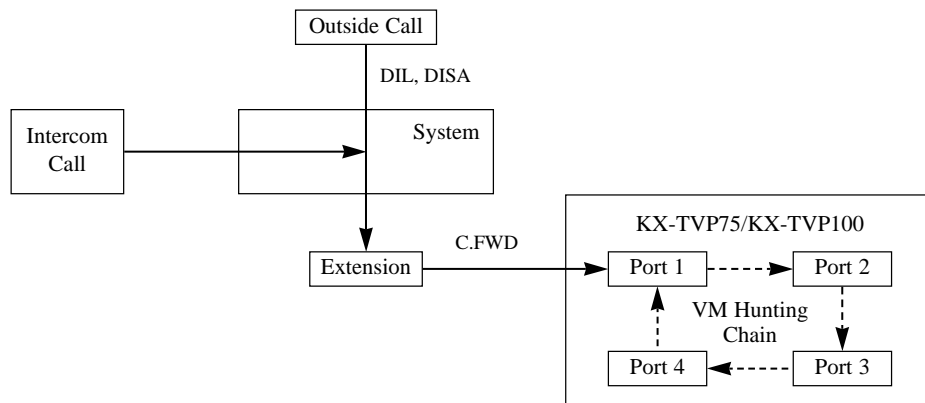

1.2 DISA Intercept to VM

If the VPS is set as the Intercept destination of an outside (CO) line, an outside call is forwarded to the VPS. The system sends the VPS the extension mailbox number at that time. Therefore, the calling party can leave their message in the mailbox of the desired extension without having to know the mailbox number. If a DISA call is transferred to the VPS by Intercept Routing from a DISA ring group, your system will transmit the mailbox number of the lowest jack number of the DISA ring group. Delayed Ringing must be assigned to VPS extensions in programs [411]-[413].

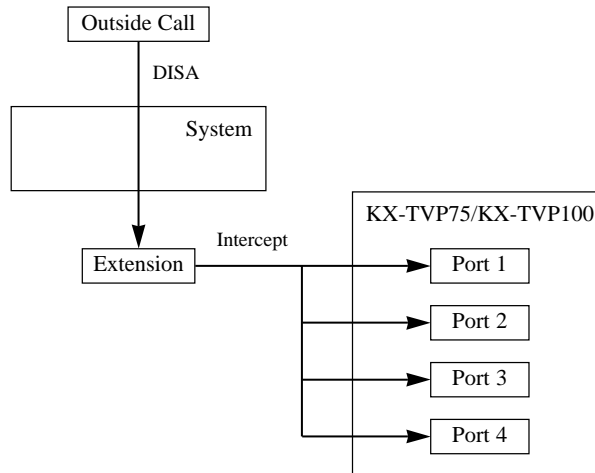

1.3 Listening to a Recorded Message

If the VPS receives a message, the VPS can turn on the MESSAGE button indicator on the corresponding proprietary telephone to notify to the user. The VPS notifies the extension user that there is a message waiting in their mailbox. When the MESSAGE button indicator is lit, pressing the button allows the extension user to play back the stored message. A single line telephone user hears dial tone 3 (☞ “Distinctive Dial Tones” in this section) when going off-hook if there are messages in their mailbox. They can call the voice mail extension to listen to their messages. In this case, they must listen to all of the messages. Once they access voice mail, dial tone 3 will be eliminated and not be heard next time they go off-hook. Therefore, they will not know even if there are messages left.

2. Automated Attendant (AA) Service

2.1 AA to Extension

AA receives and answers outside calls and offers services such as transferring to an extension or mailbox using DTMF signaling, which is sent from the calling party.

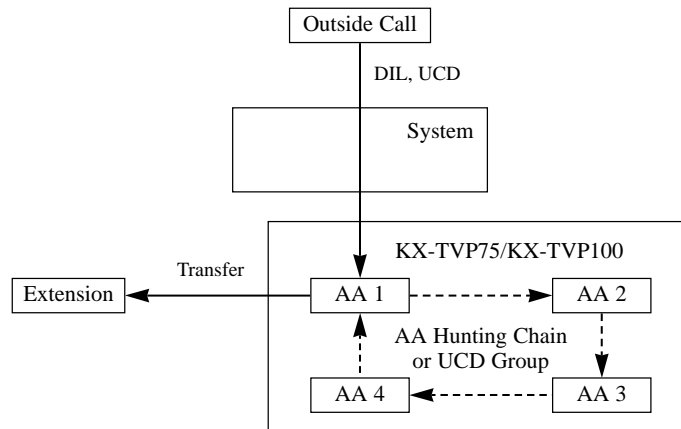

- A VPS can be assigned as the destination for the following features.
 - Call Forwarding – All Calls
 - Call Forwarding – Busy/No Answer
 - DISA Intercept Routing – No Answer

In these functions, the caller does not need to know the mailbox number of the called extension because the code is automatically transmitted to the VPS.

- The mailbox number is the same as its extension number.
- The Voice Mail extension should set Data Line Security to achieve proper recording.
- If KX-TA308 or KX-TA616 cannot be selected with the PBX type setup menu of the KX-TVP75/KX-TVP100, select “KX-T1232”. Follow the steps for a KX-T1232.



- **Connection Reference**

- 2.8 Extension Connection

- **Required System Programming**

- [009] Extension Number Assignment
 - [102] Voice Mail Port for KX-TVP75/KX-TVP100
 - [103] DTMF Integration for KX-TVP75/KX-TVP100
 - [408]-[410] Flexible Ringing Assignment — Day/Night/Lunch
 - [411]-[413] Delayed Ringing Assignment — Day/Night/Lunch
 - [414]-[416] Outside (CO) Line Mode — Day/Night/Lunch
 - [507] DISA Intercept Mode

- **Related Feature References**

- Call Forwarding, Data Line Security, Direct Inward System Access (DISA), Distinctive Dial Tones, Intercept Routing, Station Hunting

- **Operating Instructions Reference**

- 1.7 Useful Features, “Voice Mail Integration for KX-TVP75/KX-TVP100”

Volume Control

Allows a proprietary telephone user to adjust the following volumes, as necessary, by adjusting the corresponding levers or pressing the corresponding buttons.

- Handset receiver volume
- Headset volume
- Ringer volume
- Speaker volume



- **Operating Instructions Reference**

- 1.2 Proprietary Telephone Settings, “Volume Control — Handset Receiver/Headset / Ringer/Speaker”

Walking COS

Allows an extension user who is not at their own telephone to override the toll restriction COS number of another extension by dialing their extension password. For the duration of the call, the COS of the extension is changed to the COS of their own extension.



- If the extension overriding toll restriction is assigned to “Forced” or “Verify-All”, the user must enter the account code before the line access code.
- When a user makes a call using this feature, the user’s extension number will be displayed on the SMDR, not the extension where the user made the call.



- **Operating Instructions References**

- 1.7 Useful Features, “Calling Using Your Privileges at Another Extension (Walking COS)”
- 1.8 Operator / Manager Service Features, “Extension Password Set (Manager only)”

Section 4
System Programming

4.1 Before System Programming

NOTE:

System data clear should be performed before System Programming.

(☞ 2.22, Starting the System for the First Time)

Default Setting

This system has factory default settings (☞ 5.1, Default Values). If any of the programming needs to be changed, you can change the setting by System Programming. **Default** shows you the factory default setting. Any required changes can be written in the Programming Tables listed in section 7, Programming Tables.

Required Telephone Set

One of the following display telephones is required for System Programming.

- KX-T7330, KX-T7030, KX-T7130 or KX-T7033

Connect the telephone to the following.

- Jack number 01

Before entering the programming mode

Before entering the programming mode, confirm that:

- Your telephone is on-hook.
- No calls are on hold at your telephone.

Placing the Overlay on a Telephone

A programming overlay is packed with the telephone at the factory. This overlay should be used at all times during programming. The functions of the telephone keys change during programming as shown below.

Location of Controls with the Overlay

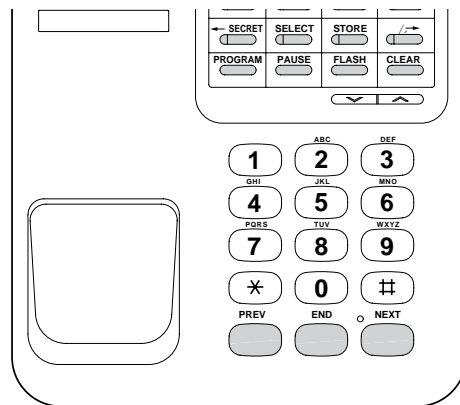

KX-T7330

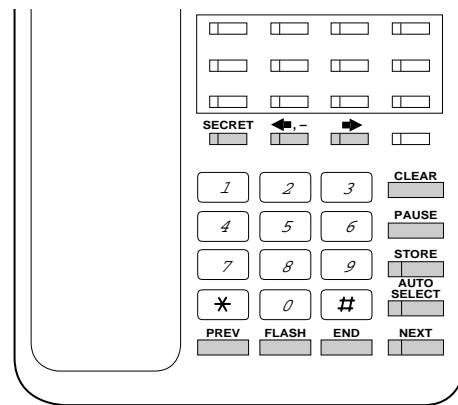

KX-T7030/KX-T7033

4.1 Before System Programming

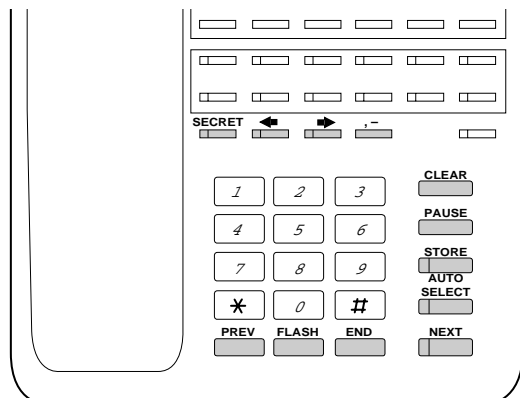

KX-T7130

To enter the programming mode

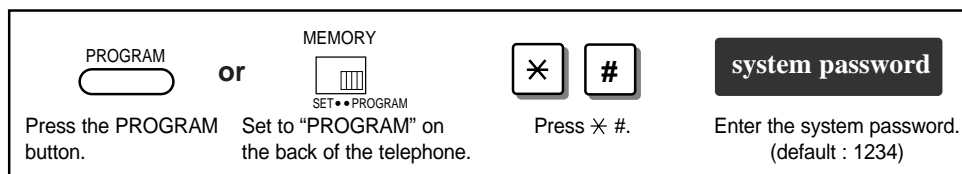

- ! The system password can be changed by program [002] "System Password".
- During the programming mode, your extension is treated as a busy extension.
- If you enter the wrong system password, you will hear an alarm tone (3 beeps). Try again.

Programming sequence

After entering the programming mode

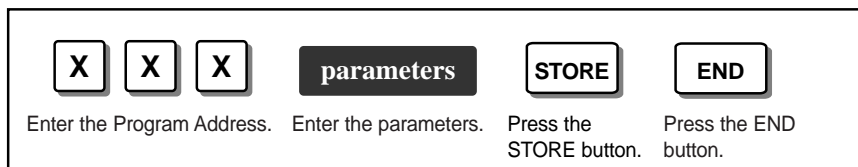

After pressing the STORE button, you will hear one of the following tones.

- Confirmation tone (1 beep):** This informs you that storing is completed. You can continue programming by entering the same or another program address
- (2 beeps):** This informs you that the same parameter has already been stored.
- Alarm tone (3 beeps):** This informs you that the entry is invalid.

To exit the programming mode

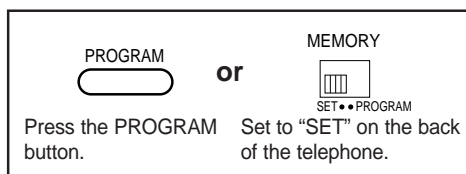

4.1 Before System Programming

Programming example

The following programming instructions assume that you have already entered the programming mode.

Example: Program [404] “Outside (CO) Line Group Assignment”

Program address

Program title

[404] Outside (CO) Line Group Assignment

Program description

Assigns a maximum 6 outside (CO) line groups. Each outside (CO) line must be assigned to an outside (CO) line group. For example, if there are multiple telephone service companies available, outside (CO) lines can be grouped by the company.

4

0

4

NEXT

outside line no.*¹

outside line group no.*²

STORE

END

(1...6/*)

(1...6)

NEXT or PREV

SELECT

¹ Outside (CO) line number: 1 through 6 / (All outside lines)

*² Outside line (TRK) group number: 1 through 6

Default Outside (CO) line 1 through 6 – Outside (CO) line group 1 through 6

! Each outside (CO) line can only belong to one outside (CO) line group.

• Feature Reference
Section 3, Features
Outside Calling

Additional information

Provides the factory default setting. If you change the setting, write the programmed data in the programming table listed in section 7, Programming Tables.

Program sequence:

1. Enter program address “404”.
2. Press “NEXT”.
3. Enter the outside (CO) line number (1 through 6) or press * to select all outside (CO) lines.
4. Enter the outside (CO) line group number (1 through 6).
5. Press “STORE”.
6. Press “END”.

To continue assigning another outside (CO) line number, press “SELECT” instead of “END” and repeat from step 3.

You can also continue assigning by pressing “PREV” or “NEXT” instead of “END”.

You can go to the previous or next outside (CO) line and repeat from step 4.

Additional Information

- When you press *, for example in step 3 in program [404], if all outside (CO) lines have been assigned as outside (CO) line group 1, “CO* : TRK GRP – 1” will be displayed. If each outside (CO) line has been assigned to a different outside (CO) line group, “CO* : Mixed” will be displayed.
- You can press the SELECT button repeatedly to select the desired parameter, if available.
- You can use the or button to move to the next/previous step, if available.

[000] Date and Time Setting

Sets the current date and time.

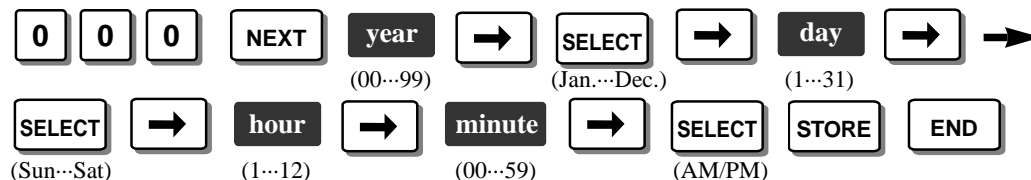

Default '98 Jan. 1 Thu 12:00 AM

- ! To return to the previous programming step, press **←**.
- ! To correct a wrong entry for the year, day, hour or minute, press the CLEAR button and enter the new one in each step.
- ! After changing an entry, you can press the STORE button. You do not have to perform the rest of the steps.
- ! The clock starts immediately after the STORE button is pressed.
- ! The system supports years from 1998 to 2097.



• **Feature References**

Section 3, Features

Date and Time Setting, Station Message Detail Recording (SMDR)

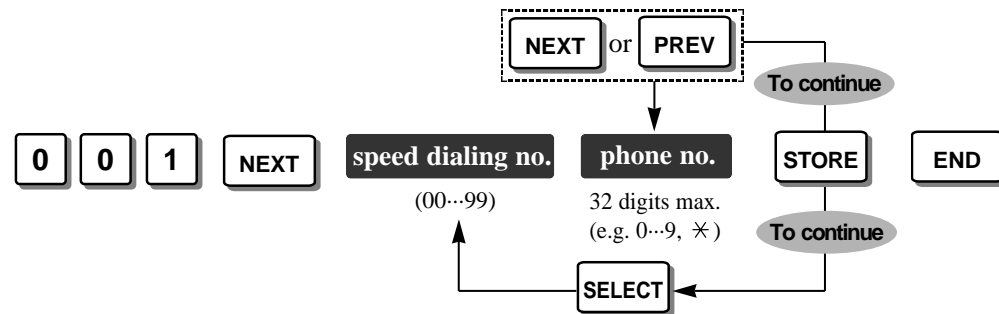

[001] System Speed Dialing Entry

Assigns a maximum of 100 System Speed Dialing numbers. To delete a stored phone number, press the CLEAR and STORE buttons after entering the Speed Dialing number.



Default Not stored.

- ! To correct a wrong entry, press the CLEAR button and enter the new one.
- ! A line access number (9 or 0, 81 through 86) should be included before the phone number.

- Up to 32 digits, consisting of “0 through 9”, “*,” “#”, “PAUSE”, “—”, “FLASH” and “ICM (Secret)” can be stored.
- If you are storing an account code assigned in [310] “Account Codes”, enter ** and the account code after a line access number.
- If you want to conceal all or part of a System Speed Dialing number on the display, enter “[” and “]” (press the ICM button) before and after the part you want to conceal. Do not press the ICM button before and after a line access number (9 or 0, 81 through 86) or an account code. “[” and “]” are counted as one digit.
- Press  or  to scroll the display



- **Feature References**
Section 3, Features
Secret Dialing, System Speed Dialing

[002] *System Password*

Assigns the password required for entering the System Programming mode. Also it is used to set an extension password.

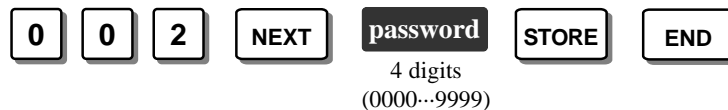

Default 1234



- To correct a wrong entry, press the CLEAR button and enter the new one.



- **Feature Reference**
Section 3, Features
Extension Password / System Password

[003] DSS Console Port Assignment

Assigns a maximum of 2 jack numbers to connect the DSS console(s).

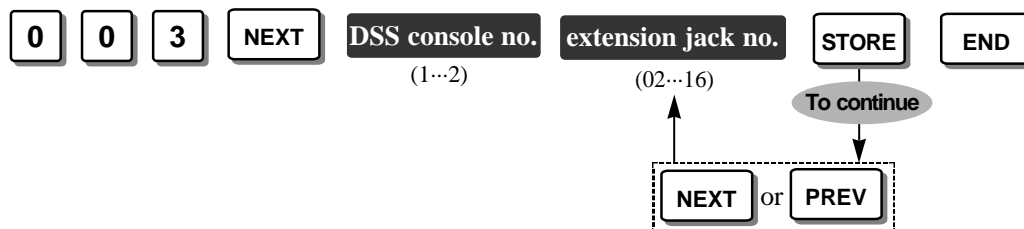

Default All DSS consoles – Disable (Not stored)



- Two DSS consoles cannot be assigned to the same jack number.
- Extension jack 01 is the manager extension. So please do not assign extension jack 01 as the DSS console jack.
- To not assign an extension jack number, press the CLEAR button in the extension jack number step.
- The extension jack number which has already been assigned as a paired telephone in program [004] “Paired Telephone Assignment for DSS Console” is not available in this program.



- **Feature Reference**
Section 3, Features
DSS Console

[004] Paired Telephone Assignment for DSS Console

Assigns a jack number for an extension paired with the DSS console.

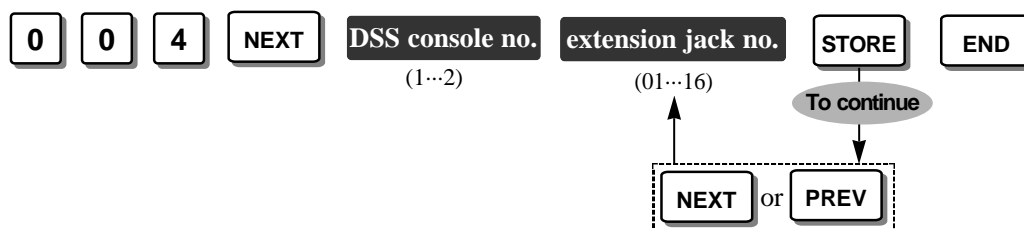

Default Extension jack number paired with DSS console 1 – Disable (Not stored)
Extension jack number paired with DSS console 2 – Disable (Not stored)



- A single line telephone (SLT) cannot be paired with the DSS console.
- To not assign an extension jack number, press the CLEAR button in the extension jack number step.
- The extension jack number which has already been assigned as a DSS console in program [003] “DSS Console Port Assignment” is not available in this program.



- **Feature Reference**
Section 3, Features
DSS Console

[005] One-Touch Transfer Using a DSS Button

Selects how an outside call is transferred to any extension using the DSS button.

With Transfer: Press the DSS button to transfer an outside call.

Without Transfer: Press the TRANSFER button then the DSS button to transfer an outside call.



(With Transfer/
Without Transfer)

Default With Transfer



- This program is effective for 2 kinds of DSS buttons. One is on the DSS console, and the other is flexible CO button on your proprietary telephone assigned as a DSS button.



- **Operating Instructions References**

1.2 Proprietary Telephone Settings, “Customizing the Buttons on Your Telephone”,
DSS (Direct Station Selection) Button

1.9 DSS Console Features, “Initial Settings”, One-Touch Dialing Assignment

[006] Time (Day/Night/Lunch) Service Changing Mode

Selects changing the day, night and lunch service manually or automatically. For manual changing, refer to the Operating Instructions. For automatic changing, set the next program [007] “Time (Day/Night/Lunch) Service Start Time”.



(Man/Auto)

Default Manual



- **Feature Reference**

Section 3, Features

Time (Day/Night/Lunch) Service

[007] Time (Day/Night/Lunch) Service Start Time

Sets the starting time on a week day basis, when “Automatic” is selected in program [006] “Time (Day/Night/Lunch) Service Changing Mode”.

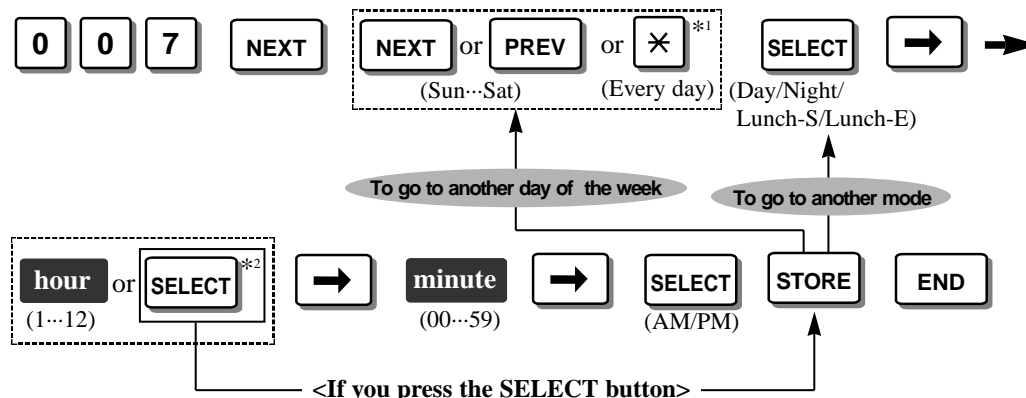

*1 To assign every day of the week to one selection, press the * button.

*2 If the SELECT button is pressed, the display will show the previous entry. If the previous setting was “None”, press the SELECT button to enter the starting time. If you do not need to change the time service, keep pressing the SELECT button until “None” is displayed. For example, if Monday’s day mode is set to “None”, the day mode will not be turned on Monday.

Default Everyday – Day – 9:00 AM / Night – 5:00 PM /
 Lunch-S (starting) – None / Lunch-E (ending) – None



• Feature Reference

Section 3, Features

Time (Day/Night/Lunch) Service

[008] Operator Assignment

Assigns an extension jack number for the operator.



Default Jack-01



- **Feature References**
 Section 3, Features
 Operator / Manager Extension, Operator Call

[009] Extension Number Assignment

Selects an extension numbering plan, **Plan 1**, **Plan 2** or **Plan 3**, and assigns an extension number to each extension.

- Plan 1:** Available extension numbers are 100 through 199.
- Plan 2:** Available extension numbers are 100 through 499.
- Plan 3:** Available extension numbers are 10 through 49.

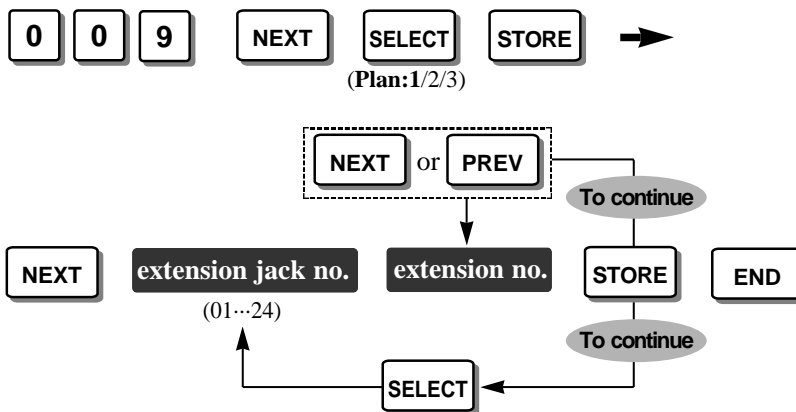

Default Plan 1: extension jacks 01 through 24 – extension numbers 101 through 124



- If the selected extension numbering plan is the same as the previously stored one, 2 beeps will be heard.
- If “Plan 2” or “Plan 3” is selected, the default extension numbers will change automatically as follows.
 - Plan 2: extension jacks 01 through 24 – extension numbers 101 through 124
 - Plan 3: extension jacks 01 through 24 – extension numbers 11 through 34
- If “Plan 2” or “Plan 3” is selected, some feature numbers will also change. Refer to the attached leaflet for details.
- A double entry of the extension number is invalid. If the programmed extension number is the same as a previously stored one, 2 beeps will be heard when the STORE button is pressed. When extension number 103 has already been assigned to jack number 03, to assign extension number 103 to the jack number 05, change the extension number of jack number 03 to another one. Then assign extension number 103 to jack number 05.
- If a Voice Processing System (VPS) is connected to the system, select “Plan 1” or “Plan 2” in this program and “Enable” in [103] “DTMF Integration”, so that the DTMF integration between VPS and the system can be enabled.
- If a rotary telephone is used at any extension, select “Plan 1” in this program.



- **Feature Reference**
 Section 3, Features
 Intercom Calling

[010] LCD Time Display Selection

Selects how the current time and date will be displayed on a proprietary telephone while idle. Either 12 hour or 24 hour (military time) can be selected.



Display example:

When “12 HOUR” is selected: Jan 1 11:20PM

When “24 HOUR” is selected: 1 Jan 23:20

Default 12 HOUR



- Programs [000] “Date and Time Setting” and [007] “Time (Day/Night/ Lunch) Service Start Time”, and the Timed Reminder feature are assigned using 12-hour time regardless of this program. The SMDR printout is also printed using 12-hour time.

[011] System Speed Dialing Name Setting

Assigns a name to each System Speed Dialing number. The name will be displayed when making a call by using the System Speed Dialing feature. It will also be used for the Caller ID feature.

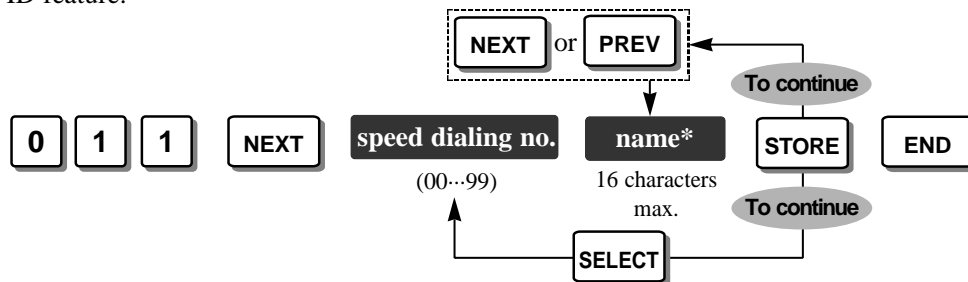

* Name:
Combination Table

Pressing SELECT (Times)	0	1	2	3	4	5	6
1	1	Q	q	Z	z	!	?
2	2	A	a	B	b	C	c
3	3	D	d	E	e	F	f
4	4	G	g	H	h	I	i
5	5	J	j	K	k	L	l
6	6	M	m	N	n	O	o
7	7	P	p	R	r	S	s
8	8	T	t	U	u	V	v
9	9	W	w	X	x	Y	y
0	0		.	,	'	:	;
*	*	"	+	-	=	<	>
#	#	\$	%	&	@	()

<Example>

— To enter “Mike;

1. Press 6 and then press the SELECT button once to enter “M”.
2. Press 4 and then press the SELECT button 6 times to enter “i”.
3. Press 5 and then press the SELECT button 4 times to enter “k”.
4. Press 3 and then press the SELECT button 4 times to enter “e”.

Default All System Speed Dialing numbers – Not stored.

- ! To erase all letters, press the CLEAR button. To erase 1 letter, press
- Each name has a maximum of 16 characters.
- Press to scroll the display to the right side.



- **Feature References**
Section 3, Features
System Speed Dialing

[012] Second Feature Numbering Plan

Replaces any feature number with a code number 50 through 59. This is useful when selecting “Plan 2” or “Plan 3” in program [009] “Extension Number Assignment” as some feature numbers change for Plan 2 and Plan 3 and they might be difficult to remember. (Refer to the attached leaflet “Notice for the Feature Numbers”.) All extension users can dial these assigned codes instead of feature numbers.

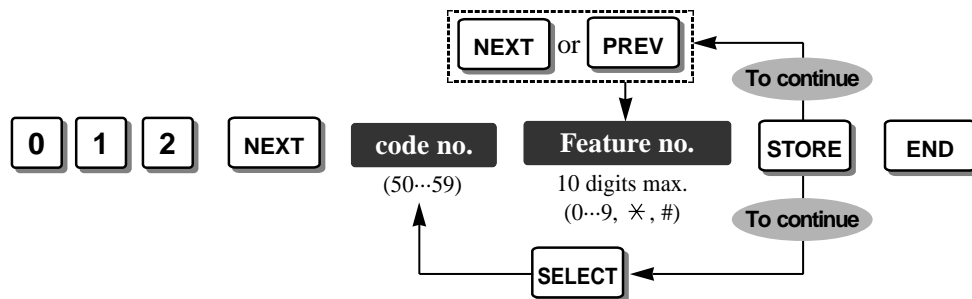

Default All codes – Not stored.



- This is not possible when “Plan 1” has been selected in program [009].

[100] Hunting Group Set

Enables or disables automatically locating an idle extension in the same extension group as the dialed extension, when the called extension is busy. If “Enable” is selected, assign the next program [101] “Hunting Type”. Extension groups are defined in program [600] “Extension Group Assignment”.

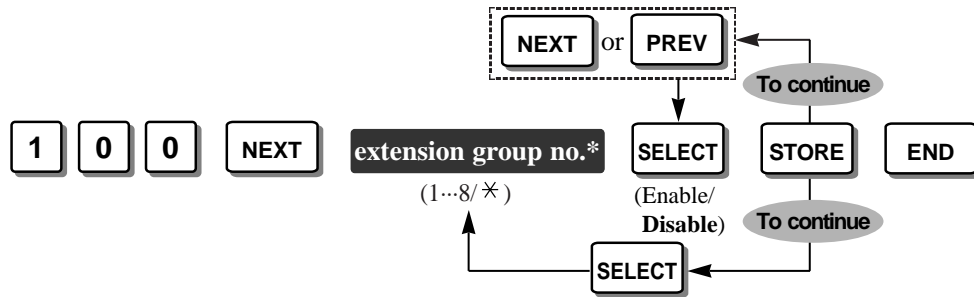

* Extension group number: 1 through 8 / * (all extension groups)

Default All extension groups – Disable



- **Feature Reference**
Section 3, Features
Station Hunting

[101] Hunting Type

Assigns the hunting type, **Terminate** or **Circular**, to each extension group when a hunting group is enabled in program [100] “Hunting Group Set”.

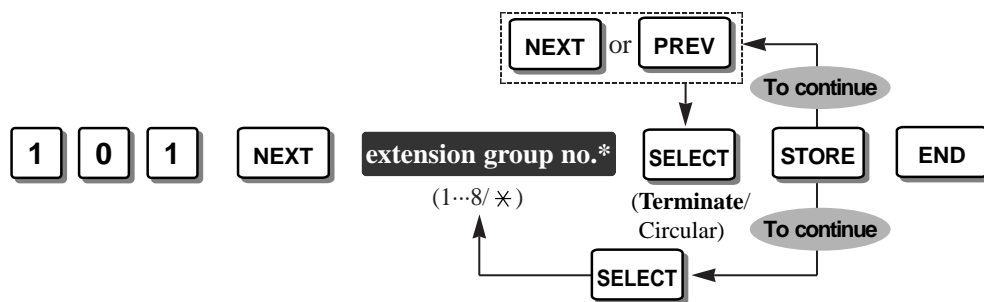

* Extension group number: 1 through 8 / * (all extension groups)

Default All extension groups – Terminate



- **Feature Reference**
Section 3, Features
Station Hunting

[102] Voice Mail Port for KX-TVP75/KX-TVP100

Assigns the extension jack number(s) connected to a Panasonic Voice Processing System (VPS) equipment (KX-TVP75/KX-TVP100). Only extension jacks 07, 08, 15 and 16 are available.

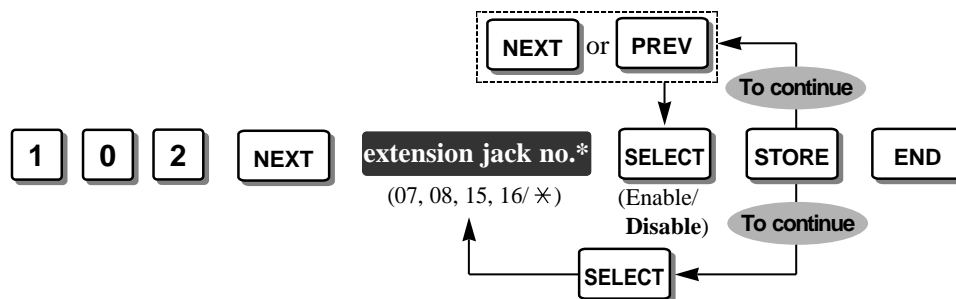

* Extension jack number: 07, 08, 15 and/or 16 / * (All 4 extension jacks)

Default All 4 extension jacks – Disable



• **Feature Reference**

Section 3, Features

Voice Mail Integration for KX-TVP75/KX-TVP100

[103] DTMF Integration for KX-TVP75/KX-TVP100

Enables or disables the system to send codes (DTMF signals) to the extension(s) assigned as the Voice Mail Port in program [102] “Voice Mail Port for KX-TVP75/KX-TVP100”. These DTMF signals indicate the state of the call (busy, answered, ringing, disconnected, etc.) in addition to the normal call tones. They also enable the Panasonic Voice Processing System (VPS) equipment (KX-TVP75/KX-TVP100) to immediately recognize the current state of the call and speed up the call handling.



Default Disable



- The table on next page describes the codes (DTMF signals), call state and conditions for the DTMF integration operation.
- Select “Plan 1” or “Plan 2” in program [009] “Extension Number Assignment”, and select “Enable” in this program to enable the DTMF integration.
- This feature greatly improves the performance of the Panasonic KX-TVP75/KX-TVP100: Voice Processing Systems which have been programmed for Inband Signaling. For more information about Inband Signaling, refer to your Voice Processing System manual.

• **Feature Reference****Section 3, Features**

Voice Mail Integration for KX-TVP75/KX-TVP100

DTMF signals

Code	Call State	Conditions
1	Ringback Tone	When an extension a VPS has dialed is ringing.
2	Busy Tone	When an extension a VPS has dialed is busy.
3	Reorder Tone	When a VPS dials an invalid extension number or when a VPS is accidentally connected to another Voice Mail Port.
4	DND	When an extension a VPS has dialed sets the DND (Do Not Disturb) feature.
5	Answer	When an extension which a VPS has dialed answers the call.
6	Forwarded to Voice Processing System (Ringing)	When a called extension is forwarded to a VPS, the call can be forwarded to another available VPS. In this way, the first VPS, typically an Auto-Attendant, can release the call to another VPS and receive another incoming call.
7	Forwarded to Voice Mail (Busy)	When a called extension is forwarded to a VPS and no VPSs are available to receive the call.
8	Forwarded to Extension	When a called extension is forwarded to another, non-VPS extension.
9	Confirmation Tone	When a VPS has successfully turned a message waiting lamp on or a message waiting lamp off.
#9	Disconnect	When the calling party disconnects.

[104] *Hold Mode Selection*

You can select how to hold a line and transfer a call to another extension with a single line telephone (SLT), **Hold-1**, **Hold-2** or **Hold-3**. If the following occurs frequently with an SLT, select “Hold-2” or “Hold-3”.

- Nobody answers when a call is received.
- A busy tone is heard even though nobody is using the outside (CO) line.

If a call is not terminated after going on-hook, the above cases occur. To avoid these problems, select “Hold-2” or “Hold-3”. Every call will be terminated unless 20 is dialed after flashing the hookswitch in the Hold-2 and Hold-3 modes.

Hold-1: To hold a line or transfer a call, flash the hookswitch.

Hold-2: To hold a line, flash the hookswitch and dial 20. To transfer a call, flash the hookswitch.

Hold-3: To hold a line or transfer a call, flash the hookswitch and dial 20.

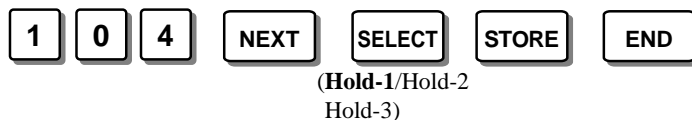

Default Hold-1



- **Feature Reference**
Section 3, Features
Hold

[105] *Conference Tone*

Enables or disables the confirmation tone before starting or ending a conference call established by the Conference feature or Executive Busy Override feature.



Default Enable



- **Feature References**
Section 3, Features
Conference (3-party), Conference (5-party), Executive Busy Override

[106] External Paging Access Tone

Enables or disables the confirmation tone before paging is sent over the external pager.

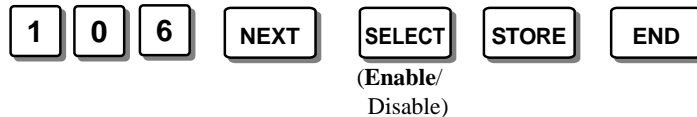

Default Enable



- **Feature Reference**
Section 3, Features
Paging

[107] DTMF Receiver Check

Enables or disables the 6 DTMF receivers to check whether the DTMF receivers are activated normally or not. Refer to the Section 6 Troubleshooting, “While Operating” for further information on checking the DTMF receivers.

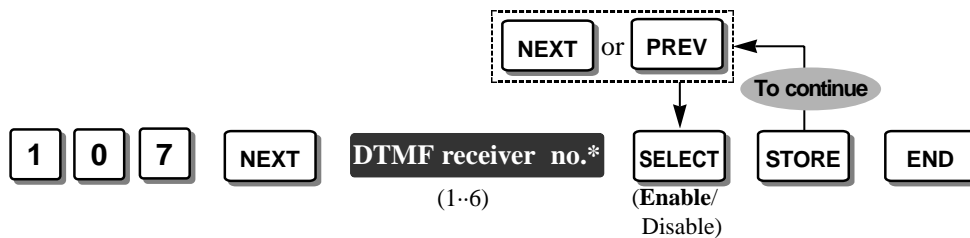

- * DTMF receiver number: 1 and 2 (for checking extension jacks 01 through 08)/
3 and 4 (for checking extension jacks 09 through 16)/
5 and 6 (for checking extension jacks 17 through 24)

Default All DTMF receivers – Enable

[108] Flash Mode for a Station Locked Extension

Enables or disables a station locked extension to send a flash signal during a conversation with an external party.



Default Disable

[109] CO Indicator Assignment

Enables or disables an extension which was assigned not to ring in programs [408]-[410] “Flexible Ringing Assignment” to answer an incoming outside call. The CO button indicator will flash when an outside call is received. If enabled, an extension user can answer the call by pressing the flashing CO button. If disabled, the user cannot answer the call even if they press the CO button.



Default Enable



- The extension must be a proprietary telephone with a CO button and indicator.

[110] Flash Key Mode

Assigns the sending of the flash signal mode, **MODE 1** or **MODE 2**, when the FLASH button on a proprietary telephone is pressed.

MODE 1: The flash signal is sent during the programmed time in [418] “Flash Time”.

MODE 2: The flash signal is sent while the FLASH button is pressed if the time the FLASH button was pressed is more than the programmed time in [418]. This will be useful to disconnect the current call and make another call without hanging up. If the time the FLASH button was pressed is less than the programmed time in [418], the flash signal will be sent during the programmed time.



Default MODE 1



- **Feature Reference**
Section 3, Features
Flash

[111] Hold Music Selection

Selects the music source, **Internal**, **External** or **Tone**, which an external party will hear when an outside call is on hold.

External : Uses an external music source, such as a radio.

Internal : Uses the internal music source equipped with the system.

Tone : Uses the cyclic tone below equipped with the system.



(Internal/
External/Tone)

Default Internal



- The music source can also be used for BGM.



- **Feature Reference**

Section 3, Features

Music on Hold / Background Music (BGM)

[112] DSS Console Indication Mode

Enables or disables the Busy Lamp Field (BLF) on the DSS button to indicate the status, Forward (FWD) or Do Not Disturb (DND), of corresponding extensions.



(Enable/
Disable)*

- * Enable: FWD – Flashing slowly, DND – Flashing moderately
- Disable: FWD – Off, DND – Off

Default Enable



- **Feature Reference**

Section 3, Features

DSS Console

[113] Automatic Redial Repeat

Selects the number of times Automatic Redial is repeated.

(0/3/10/
15 times)

Default 10 times



- **Feature Reference**
Section 3, Features
Redial

[114] Automatic Redial Interval Time

Selects the interval time between Automatic Redial attempts.

(40/60 sec)

Default 60 seconds



- **Feature Reference**
Section 3, Features
Redial

[115] Extension Ringing Pattern Selection

Selects the extension ringing pattern when an intercom call received, either **Single**, **Double** or **Triple**.

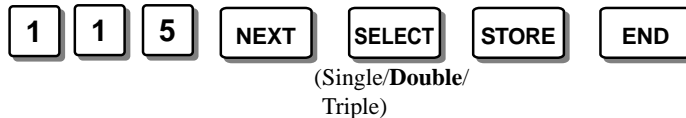
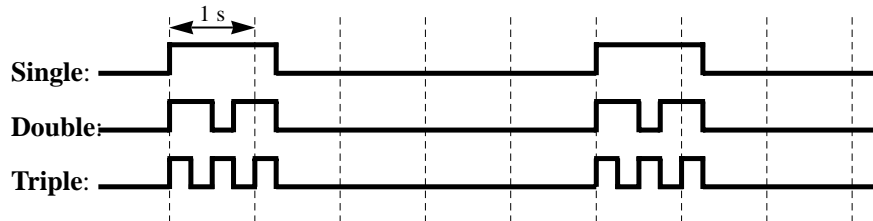

Default Double



- The length of the ring cycle for a single line telephone (SLT) is determined in program [124] "SLT Ringing Mode Selection".
- The extension ringback pattern is determined at the same time.



- **Feature Reference**
Section 3, Features
Ringing Pattern Selection

[116] Conference Pattern Selection

Selects the maximum number of external parties which can attend a conference. The maximum number of conference parties is 5.

- 3-party C-0 E-3:** No external parties can attend a 3-party conference.
- 3-party C-1 E-3:** One external party can attend a 3-party conference.
- 3-party C-2 E-3:** A maximum of 2 external parties can attend a 3-party conference.
- 5-party C-2 E-5:** A maximum of 2 external parties can attend a 5-party conference.

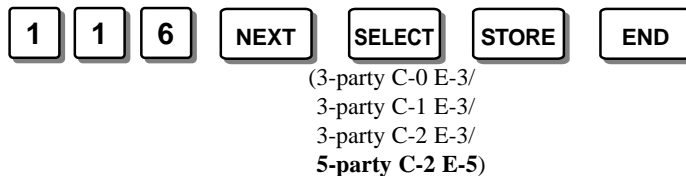

Default 5-party C-2 E-5



- **Feature References**
Section 3, Features
Conference (3-Party), Conference (5-Party)

[117] *Call Pickup Tone*

Enables or disables the confirmation tone when the Call Pickup feature is activated.

1 1 7 NEXT SELECT STORE END
(Enable/
Disable)

Default Enable



- **Feature Reference**
Section 3, Features
Call Pickup

[118] *Pulse Restriction*

Enables or disables sending pulse dialing to the Central Office during a conversation with an external party when “Pulse Mode” or “Call Block Mode” is selected in program [401] “Dial Mode”.

1 1 8 NEXT SELECT STORE END
(Enable/
Disable)

Default Enable

[119] *Redialing after Pulse to Tone Conversion*

Enables or disables sending tone dialing to the Central Office when an extension user redials after changing the pulse mode into tone mode by pressing * and #.

1 1 9 NEXT SELECT STORE END
(Enable/
Disable)

Default Disable



- **Feature Reference**
Section 3, Features
Pulse to Tone Conversion

[120] Bell Frequency

Selects the bell frequency sent to a single line telephone (SLT).

1 2 0 NEXT SELECT STORE END
(20/25 Hz)

Default 25 Hz

[121] Automatic Outside (CO) Line Access Number Selection

Selects the Automatic Outside (CO) Line Access number (9 or 0).

1 2 1 NEXT SELECT STORE END
(Dial 0/
Dial 9)

Default Dial 9



- If you select “0”, the operator call will automatically be “9”. If you select “9”, the operator call will automatically be “0”.



- **Feature References**
Section 3, Features
Automatic Outside (CO) Line Access Number, Operator Call

[122] Automatic Rotation for Outside (CO) Line Access

Enables or disables the rotation of outside (CO) lines seized for “Automatic Outside (CO) Line Access”.

1 2 2 NEXT SELECT STORE END
(Enable
Disable)

Default Disable (Does not rotate.)



- **Feature Reference**
Section 3, Features
Automatic Outside (CO) Line Access Number

[123] Break Ratio

Selects the pulse break rate, **MODE1** or **MODE 2**, when a Pulse is sent to the Central Office during a conversation.

MODE 1: 66 %

MODE 2: 60 %

(MODE1/
MODE2)

Default MODE 1

[124] SLT Ringing Mode Selection

Selects the length of the ring cycle for a single line telephone (SLT).

MODE 1: 5 second cycle

MODE 2: 3 second cycle

(MODE1/
MODE2)

Default MODE 1

[125] Toll Restriction Check for * and #

Assigns whether the entered "*" and "#" are checked by toll restriction or not. This assignment is required for certain Central Offices to prevent toll fraud. Some Central Offices ignore the user-dialed "*" and "#". If your Central Office ignores these symbols, select "Disable".

(Enable/
Disable)

Default Enable



- **Feature Reference**
Section 3, Features
Toll Restriction

[126] DSS Off-Hook Mode

Enables or disables making an intercom call just by pressing a DSS button on a DSS Console. If enabled, going off-hook is not needed.



Default Enable



This assignment is also effective for a flexible CO button on a proprietary telephone assigned as a DSS button.



Feature Reference
Section 3, Features
Intercom Calling

[127] Pickup Group Set

Enables or disables the ability of an extension to pickup a call ringing at another extension (if it is in the same extension group) by just going off-hook. If enabled, the feature number (40) is not needed to pickup the call.

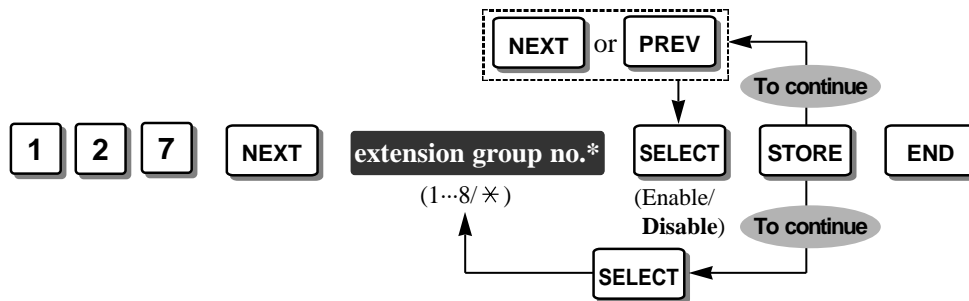

* Extension group number: 1 through 8 / * (all extension groups)

Default All extension groups – Disable (the feature number (40) is required to pickup the call)



To prevent other extensions in the same extension group from picking up outside calls by just going off-hook, select “Disable” in program [109] “CO Indicator Assignment”. Then even though “Enable” is selected in this program [127], outside calls cannot be picked up by others by just going off-hook.



Feature Reference
Section 3, Features
Call Pickup

[200] Hold Recall Time

Assigns the length of the hold recall timer. Hold recall (a ring tone or an alarm tone) is heard when the timer expires. If hold recall is not required, select "Disable".

(30 sec/
 1/1.5/2/3/4/5/6 min/
 Disable)

Default 30 seconds



- **Feature References**
 Section 3, Features
 Call Park, Hold

[201] Transfer Recall Time

Assigns the length of the transfer recall timer. If a transferred call is not answered within the programmed time, the call will be returned to the original caller.

(15/30 sec/
 1/2 min)

Default 30 seconds



- **Feature Reference**
 Section 3, Features
 Call Transfer – to Extension

[202] Call Forwarding Start Time

Assigns time for the Call Forwarding – No Answer feature. If a call is not answered within the programmed time, the call will be forwarded to the destination.

(5/10/15/20
 sec delay)

Default 15 seconds delay



- **Feature Reference**
 Section 3, Features
 Call Forwarding

[203] Pickup Dial Delay Time

Assigns the length of time for the Pickup Dialing feature. If the telephone user lifts the handset, the programmed party is called automatically when the timer expires. This delay gives the user an opportunity to enter numbers before automatic dialing occurs.

(1/2/3/4 sec)

Default 3 seconds



- **Feature Reference**
Section 3, Features
Pickup Dialing

[204] Call Duration Count Start Time

Assigns the start time of a conversation either immediately after an outside (CO) line is seized or after dialing. This corresponds to the length of the conversation displayed on the LCD and printed on the printer (SMDR).

(5/10/15/20/25/30/
 35/40/45/50 sec after
 dialing/Instantly)

Default 10 seconds after dialing



- If reverse signal detection is enabled in program [424] “Reverse (Polarity) Circuit Assignment”, the system will automatically start the timer immediately after an external party answers a call.



- **Feature References**
Section 3, Features
Polarity Reverse Detection, Station Message Detail Recording (SMDR)

[205] *Outside-to-Outside (CO-to-CO) Line Duration Time Limit*

Sets the maximum time allowed for a conversation between two external parties using the Call Forwarding – to Outside (CO) Line, Call Transfer – to Outside (CO) Line, Unattended Conference feature, or the DISA feature. When the timer expires, the outside-to-outside line call is disconnected.

2 **0** **5** **NEXT** **time** **STORE** **END**
 (1...32 min)

Default 10 minutes



- **Feature Reference**
 Section 3, Features
 Limited Call Duration

[206] *Dialing Start Time*

Assigns the minimum length of the pause time the system waits before dialing after seizing an outside (CO) line.

2 **0** **6** **NEXT** **SELECT** **STORE** **END**
 (0/250/500/750/
 1000/1250/1500 ms)

Default 0 millisecond



- **Feature Reference**
 Section 3, Features
 Outside Calling

[207] Hookswitch Flash Timing Range Selection

Sets the hookswitch flash time range sent from an extension to the system.

MODE 1: 50 to 180 milliseconds.

MODE 2: 80 to 180 milliseconds.

MODE 3: 80 to 650 milliseconds.

MODE 4: 80 to 1000 milliseconds.

MODE 5: 200 to 1000 milliseconds.



(MODE1/MODE2/
MODE3/MODE4/
MODE5)

Default MODE 4



- **Feature Reference**
Section 3, Features
Hookswitch Flash

[208] Interdigit Time

Assigns the maximum time allowed between digits for an outgoing outside call.



(5/10/15/20 sec)

Default 10 seconds



- The interdigit timer applies until the toll restriction check is completed. When the timer expires, an outgoing outside call will be disconnected while dialing, if “Enable” was selected in program [211] “No Dial Disconnection”.
- For a single line telephone, an outgoing outside call will be released from a DTMF receiver when the interdigit timer expires.



- **Feature Reference**
Section 3, Features
Toll Restriction

[210] DTMF Time

Assigns the minimum duration of a DTMF signal sent to an outside (CO) line which is set to the DTMF mode in program [401] "Dial Mode".

MODE 1: 80 milliseconds

MODE 2: 160 milliseconds

(MODE1/
MODE2)

Default MODE 1

[211] No Dial Disconnection

Enables or disables disconnecting an outside (CO) line if an extension user does not dial anything within 10 seconds after an outside (CO) line is seized.

(Enable/
Disable)

Default Disable (Does not disconnect)



- The interdigit timer assigned in program [208] "Interdigit Time" applies until the toll restriction check is completed. When the timer expires, an outgoing outside call will be disconnected while dialing, if "Enable" was selected in this program.



- **Feature Reference**
Section 3, Features
Toll Restriction

[212] *Outside (CO) Line Duration Time Limit*

Sets the maximum time allowed for a conversation with an external party. This program is effective for the extension(s) which assigned "Enable" in program [613] "Outside (CO) Line Duration Time Limit Selection".

2 1 2 NEXT **time** STORE END
(1-32 minutes)

Default 10 minutes



- A beep sounds at 5-second intervals 15 seconds before the programmed time expires.
- This program is effective only for an outgoing outside call.
- When making a call after an outside (CO) line is seized and transferred to the enabled extension in program [613] by another extension, the timer starts after the call has been transferred.



- **Feature Reference**
Section 3, Features
Limited Call Duration

[213] *Bell Off Detection*

Sets the maximum time between detecting one bell signal and the next from the Central Office. In case the next bell signal is not detected within the programmed time, the system recognizes the bell signal has stopped.

2 1 3 NEXT SELECT STORE END
(3/6/12 sec)

Default 6 seconds

[300] Carrier Excepted Code Assignment

Assigns up to 20 carrier excepted codes, for example, Per Call Block code (1831). The system disregards the assigned code, and toll restriction and ARS are applied to the numbers after the code.

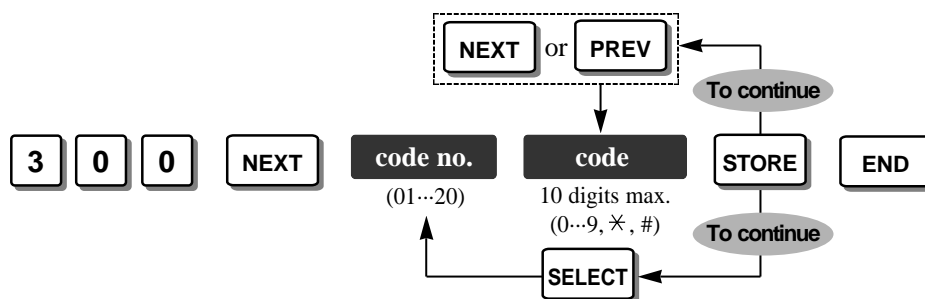

Example:

Code no. 01: 1831

Dialing number: 1831 93 425 9477

disregarded applied to the toll restriction and ARS

Default All codes – Not stored.

- ! • “x” (press the PAUSE button) substitutes any number (= wild card).
- To correct a wrong entry, press the CLEAR button and enter the new one.

[301] Toll Restriction – System Speed Dialing Boundary Class

Assigns the toll restriction class for System Speed Dialing numbers. System Speed Dialing numbers can be assigned in program [001] “System Speed Dialing Entry”.

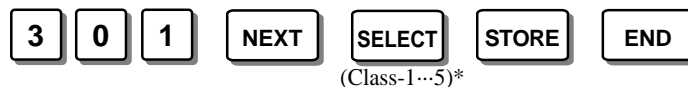

* Boundary Class: 1 through 5

Default Boundary Class -1



• Feature Reference

Section 3, Features

Toll Restriction for System Speed Dialing

[302]-[305] Toll Restriction – Classes 2 through 5 Denied Codes

Assigns up to 20 toll call numbers which are restricted to make outside (CO) calls on a class of service (COS) basis for each program.

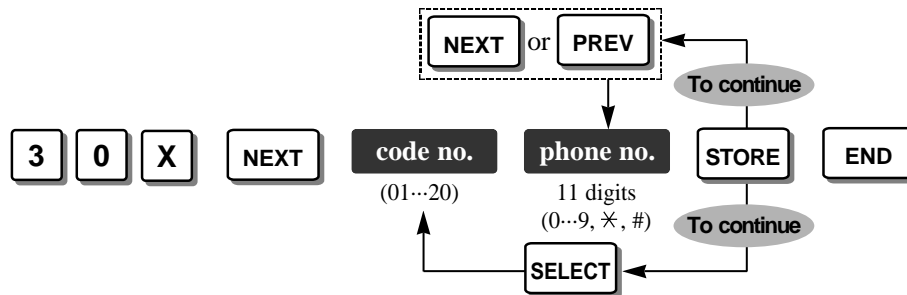

X – Program address selection number: 2 ([302] for Class 2) / 3 ([303] for Class 3) / 4 ([304] for Class 4) / 5 ([305] for Class 5)

Default All codes – Not stored.



- “x” (press the PAUSE button) substitutes any number (= wild card).
- Each phone number should consist of 11 digits.
- To correct a wrong entry, press the CLEAR button and enter the new one.



- **Feature Reference**
Section 3, Features
Toll Restriction

[306] Toll Restriction – Exception Codes

Assigns up to 80 exception numbers which are allowed to make outside (CO) calls on a class of service (COS) basis even when denied codes are programmed in [302]-[305] “Toll Restriction – Classes 2 through 5 Denied Codes”.

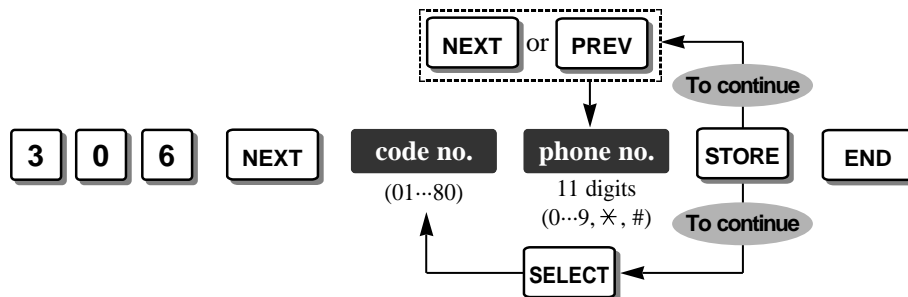

Default All codes – Not stored.

- ! • “x” (press the PAUSE button) substitutes any number (= wild card).
- Each phone number should consist of 11 digits.
- To correct a wrong entry, press the CLEAR button and enter the new one.



- **Feature Reference**
Section 3, Features
Toll Restriction

[309] Emergency Dial Number Set

Assigns up to 5 emergency numbers, for example, a police station or fire station. Calls with these numbers are free from restrictions, for example, toll restriction, Account Code – Forced/Verify–All mode and Electronic Station Lock.

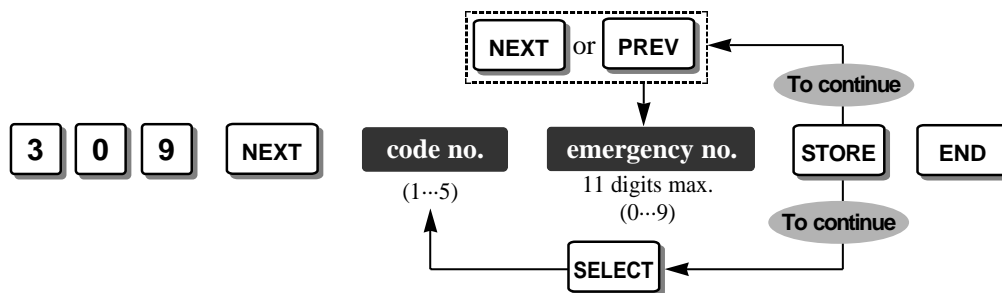

Default All codes – Not stored.

- ! • To correct a wrong entry, press the CLEAR button and enter the new one.



- **Feature References**
Section 3, Features
Emergency Call, Toll Restriction

[310] Account Codes

Assigns up to 24 account codes which are compared with the code entered when “Verify-All” or “Verify-Toll” is selected in program [605] “Account Code Entry Mode”.
 If “Verify-All” is selected, an account code is required to make an outside call.
 If “Verify-Toll” is selected, an account code is only required to override toll restriction.

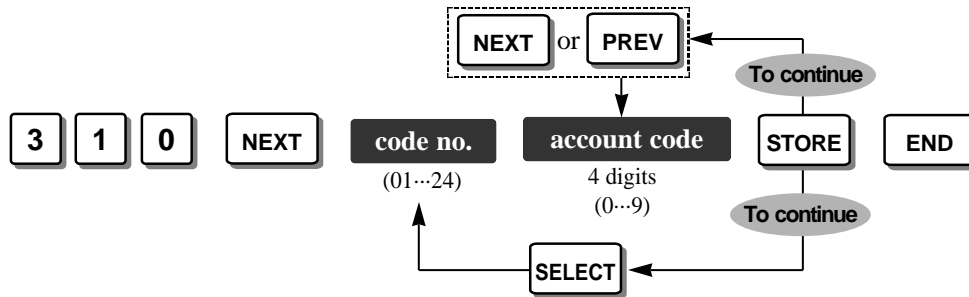

Default All codes – Not stored.



- To correct a wrong entry, press the CLEAR button and enter the new one.



Feature References

Section 3, Features

Account Code Entry, Toll Restriction Override by Account Codes

[311] Automatic Pause Insertion Codes

Assigns up to 40 automatic pause insertion codes which are checked with the outside outgoing call number. When one of the codes is the same as the call number, the pause time assigned in program [417] “Pause Time” is automatically inserted after the code. If a second dial tone is sent from your Central Office, it is convenient to assign the area code as the pause code.

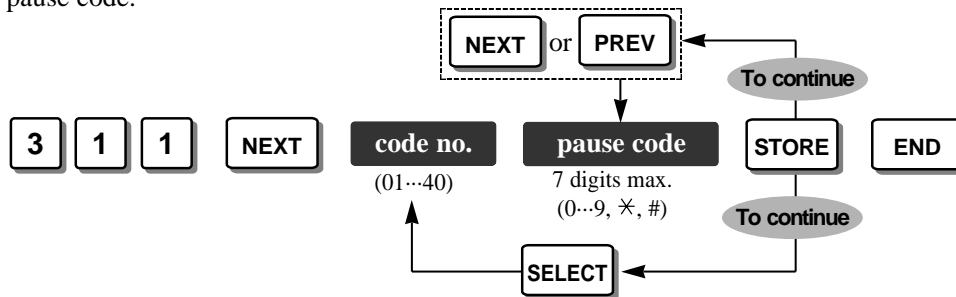

Default All codes – Not stored.



- To correct a wrong entry, press the CLEAR button and enter the new one.

[312] Toll Restriction – Station Lock Boundary Class

Assigns the Toll Restriction class for an extension which has set the Electronic Station Lockout or Remote Station Lock Control.



(Disable/
COS-2...5)*

* Boundary COS: 2 through 5 / Disable (Disables all outside outgoing calls.)

Default Disable



• **Feature Reference**

Section 3, Features

Toll Restriction – Station Lock Boundary Class

[350] ARS Selection

Enables or disables the ARS feature for each outside (CO) line.

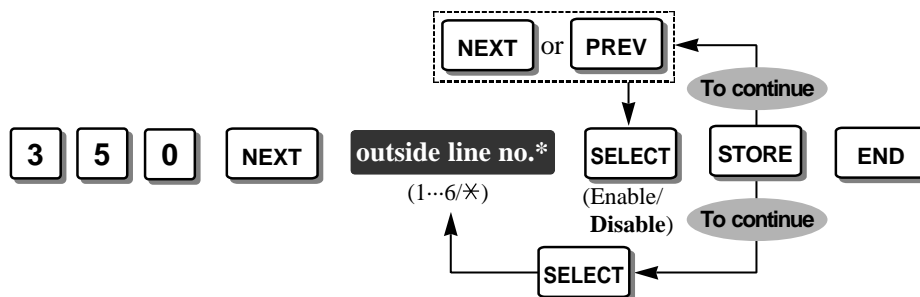

* Outside (CO) line number: 1 through 6 / * (All outside lines)

Default All outside (CO) lines – Disable



- **Feature Reference**
Section 3, Features
Automatic Route Selection (ARS)

[351]-[354] Routes 1 through 4 Selection Codes (Leading Digits)

Assigns up to 80 area codes for outside calls which are applied to the ARS feature for each route.

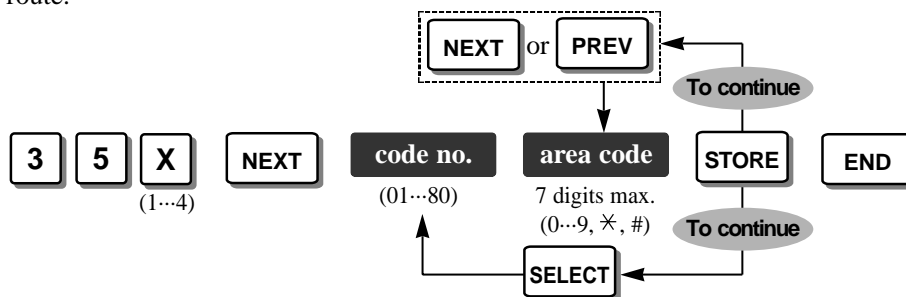

X – Program address selection number: 1 ([351] for Route 1) / 2 ([352] for Route 2) / 3 ([353] for Route 3) / 4 ([354] for Route 4)

Default All codes – Not stored.



- “x” (press the PAUSE button) substitutes any number (= wild card).
- To correct a wrong entry, press the CLEAR button and enter the new one.



- **Feature Reference**
Section 3, Features
Automatic Route Selection (ARS)

[355]-[358] Routes 1 through 4 Exception Codes

Assigns up to 80 area codes for outside calls which are not applied to the ARS feature for each route.

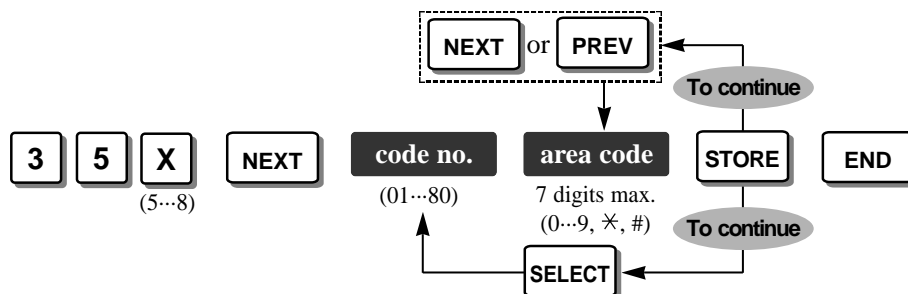

X – Program address selection number: 5 ([355] for Route 1) / 6 ([356] for Route 2) / 7 ([357] for Route 3) / 8 ([358] for Route 4)

Default All codes – Not stored.



- “x” (press the PAUSE button) substitutes any number (= wild card).
- To correct a wrong entry, press the CLEAR button and enter the new one.



- **Feature Reference**
Section 3, Features
Automatic Route Selection (ARS)

[359] 1st Carrier Selection Code

Assigns the first carrier access code. When the code is dialed, the first carrier is always selected even if the ARS feature is enabled.

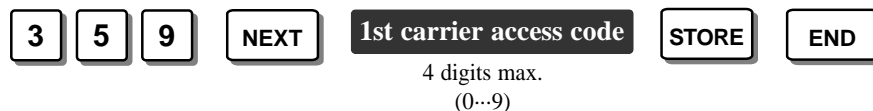

Default 000



- To correct a wrong entry, press the CLEAR button and enter the new one.



- **Feature Reference**
Section 3, Features
Automatic Route Selection (ARS)

[360] ARS Modification – Removed Digits

Determines how the dialed number applied to the ARS feature should be modified before sending to the outside (CO) line for each route. The digits are deleted from the beginning of the dialed number.

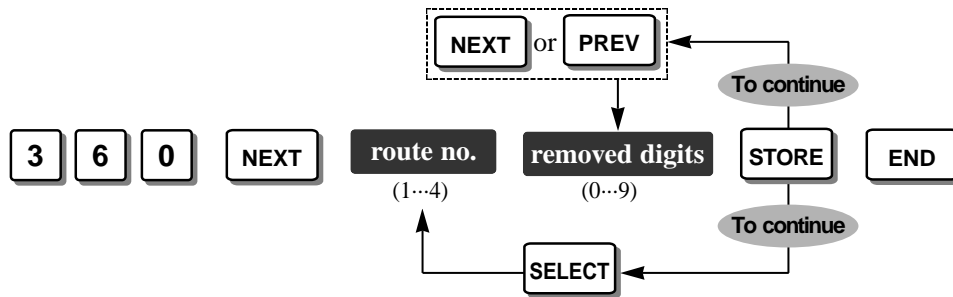

Default All routes – 0 (No deletion)



- **Feature Reference**
Section 3, Features
Automatic Route Selection (ARS)

[361] ARS Modification – Added Number

Determines how the dialed number applied to the ARS feature should be modified before sending to the outside (CO) line for each route. Numbers are added to the beginning of the dialed number. Numbers can be carrier codes, etc.

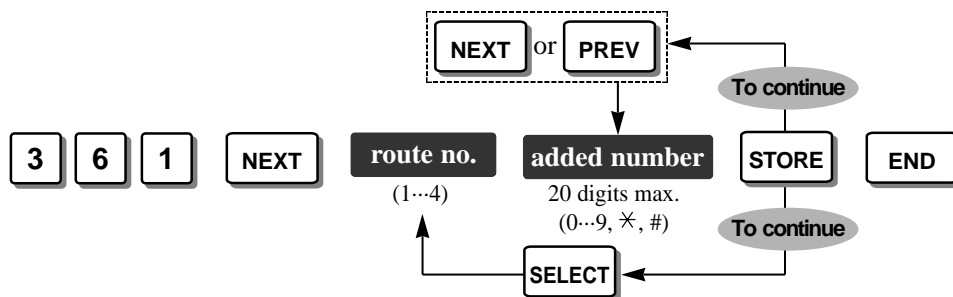

Default All routes – Not stored.

- To correct a wrong entry, press the CLEAR button and enter the new one.
- Press to scroll the display to the right side.
- The assigned numbers will be added to the dialed number after deleting the digits programmed in [360] “ARS Modification — Removed Digits”.



- **Feature Reference**
Section 3, Features
Automatic Route Selection (ARS)

[362] ARS Dial Tone Pattern Selection

Selects the dial tone pattern, **Disable** (no tone), **Tone1**, **Tone2** or **Tone3**, generated after seizing an ARS outside (CO) line. The ARS feature is enabled on an outside (CO) line basis in program [350] "ARS Selection". The tone will stop after the first digit (except for an account code) is dialed.

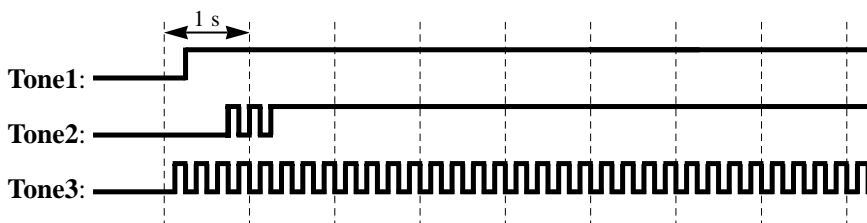

Default Tone1



- **Feature Reference**
 Section 3, Features
 Automatic Route Selection (ARS)

[363] ARS Interdigit Time

Assigns the interdigit timer (in seconds) used while the system is checking the dialed number for the ARS feature.



Default 5 seconds



- This assignment should be the same as the interdigit timer assigned in program [208] "Interdigit Time".



- **Feature Reference**
 Section 3, Features
 Automatic Route Selection (ARS)

[364] ARS Outside (CO) Line Group

Assigns an outside (CO) line group(s) for each ARS route number. Outside (CO) line groups are assigned in program [404] "Outside (CO) Line Group Assignment". An outside (CO) line in the assigned outside (CO) line group(s) is automatically seized when making an outside call using the Automatic Outside (CO) Line Access number (9 or 0), and the dialed number is applied to one of the ARS route numbers.

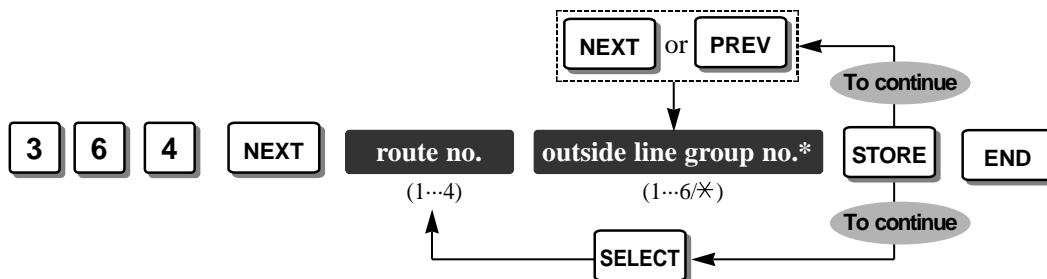

* Outside line (TRK) group number: 1 through 6 / * (All outside line (TRK) groups)

Default All routes – * (All outside line (TRK) groups)



- Programs [351]-[354] "Routes 1 through 4 Selection Codes (Leading Digits)" should be considered when assigning this program.



- **Feature Reference**
Section 3, Features
Automatic Route Selection (ARS)

[400] Outside (CO) Line Connection Assignment

Assigns which outside (CO) line(s) is connected to the system or not.

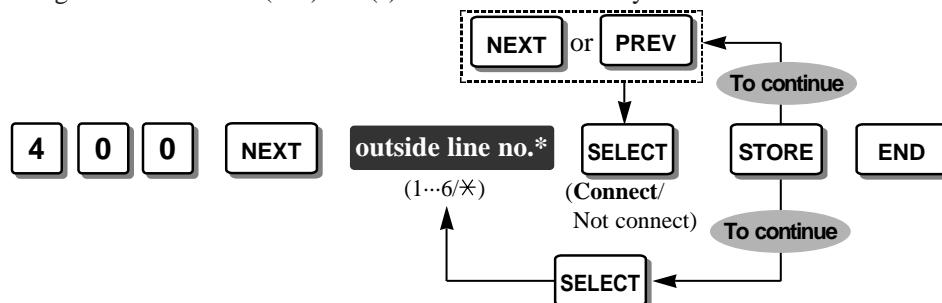

* Outside (CO) line number: 1 through 6 / * (All outside lines)

Default All outside (CO) lines – Connect



- **Feature Reference**
Section 3, Features
Outside Calling

[401] Dial Mode

Selects the dialing mode, **DTMF**, **Pulse** or **C. BLK** (Call Blocking), for each outside (CO) line.

DTMF: The dialing signals from an extension, either Tone or Pulse, are converted to Tone and transmitted to the Central Office. If the system is connected directly to the Central Office or installed behind a host PBX, which receives both Tone and Pulse, select this mode.

Pulse : The dialing signals from an extension, either Tone or Pulse, are converted to Pulse and transmitted to the Central Office.

C. BLK: If your Central Office can receive both DTMF and Pulse signals but the user are contracted for Pulse, select this mode. When dialing with a touch tone telephone, only Pulse signals are sent to the Central Office.

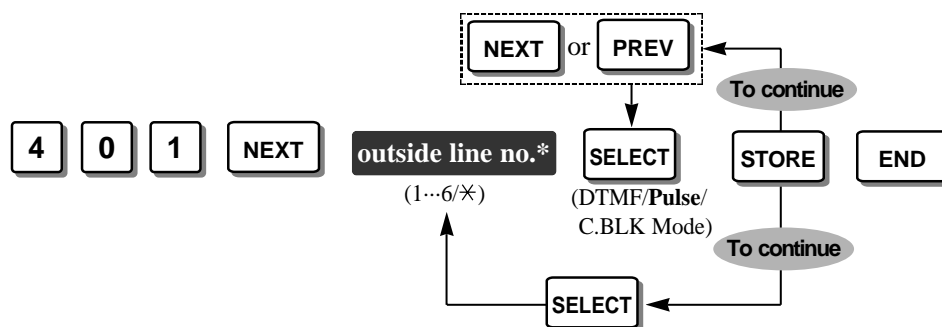

* Outside (CO) line number: 1 through 6 / * (All outside lines)

Default All outside (CO) lines – Pulse Mode



- **Feature Reference**
Section 3, Features
Pulse to Tone Conversion

[402] Pulse Speed Selection

Selects a pulse rate for each outside (CO) line which sets “Pulse Mode” or “Call block Mode” in program [401] “Dial Mode”. There are 2 pulse rates, **Low Speed** (10 pps) and **High Speed** (20 pps).

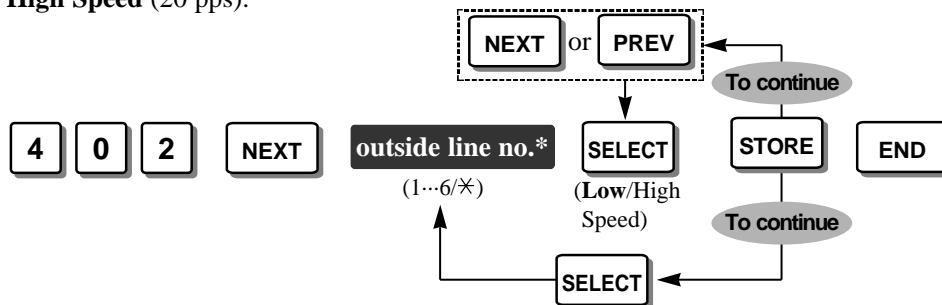

* Outside (CO) line number: 1 through 6 / * (All outside lines)

Default All outside (CO) lines – Low Speed

[403] Host PBX Access Codes

If the system is installed behind a host PBX, each outside (CO) line may require an access code to make an outside call. Up to 8 access codes can be stored for each outside line. When the programmed codes are dialed, the pause time assigned in program [417] “Pause Time” is automatically inserted, and toll restriction is applied after the code.

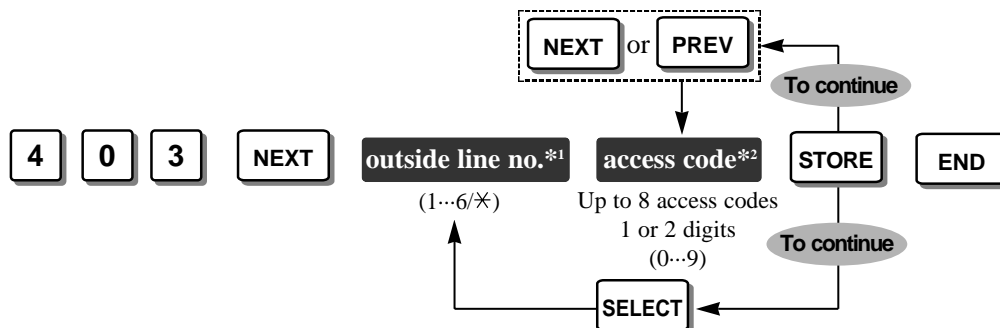

*1 Outside (CO) line number: 1 through 6 / * (All outside lines)

*2 Insert a “,” for each code using the [.] button on the overlay.

Example:

- Access codes 81, 82 on outside (CO) line number 1

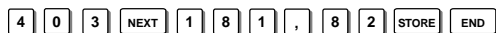

Default All outside (CO) lines – Not stored



- To correct a wrong entry, press the CLEAR button and enter the new one.

• **Feature Reference**
Section 3, Features
Host PBX Access

[404] Outside (CO) Line Group Assignment

Assigns a maximum 6 outside (CO) line groups. Each outside (CO) line must be assigned to an outside (CO) line group. For example, if there are multiple telephone service companies available, outside (CO) lines can be grouped by company.

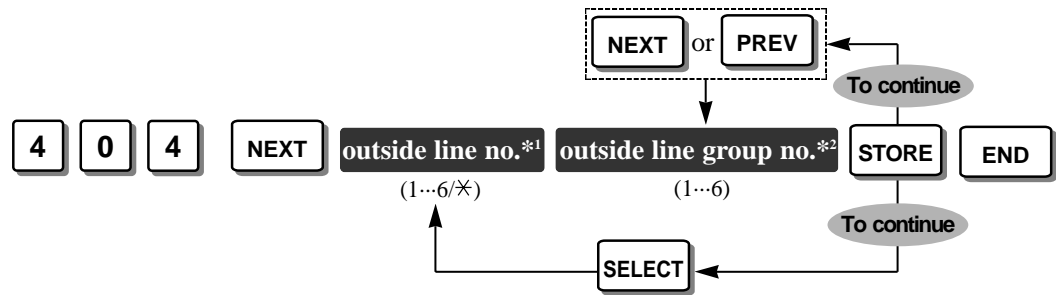

*1 Outside (CO) line number: 1 through 6 / * (All outside lines)

*2 Outside line (TRK) group number: 1 through 6

Default Outside (CO) line 1 through 6 – Outside (CO) line group 1 through 6



- Each outside (CO) line can only belong to one outside (CO) line group.



- **Feature Reference**
Section 3, Features
Outside Calling

[405]-[407] Flexible Outward Dialing Assignment —Day/Night/Lunch

Determines which extension(s) can make an outside call in the day, night and/or lunch modes.

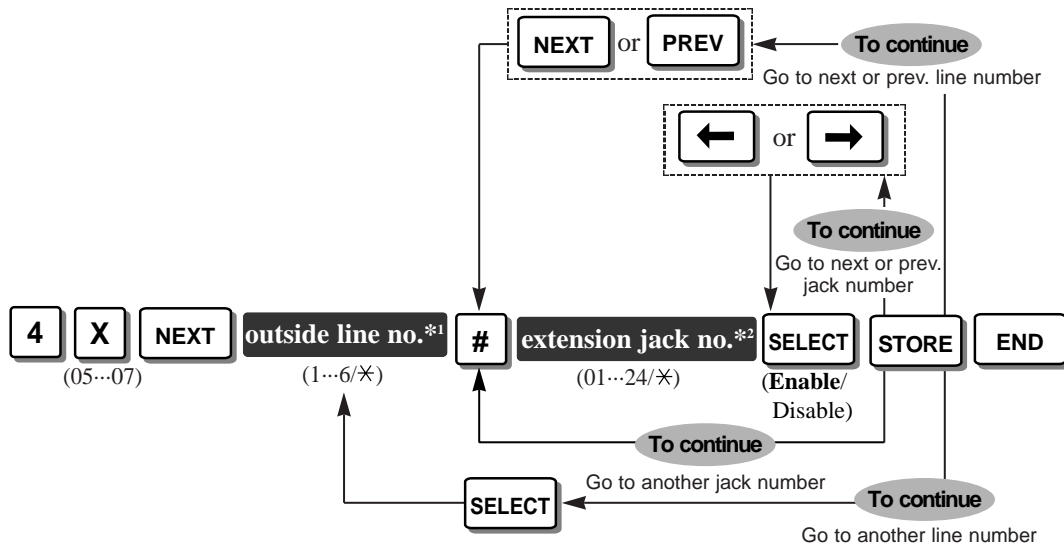

X – Program address selection number: 05 ([405] for day) / 06 ([406] for night) / 07 ([407] for lunch)

*¹ Outside (CO) line number: 1 through 6 / * (All outside lines)

*² Extension jack number: 01 through 24 / * (All extension jacks)

Default All outside (CO) lines – all extension jacks – Enable



- **Feature Reference**
Section 3, Features
Outside Calling

[408]-[410] Flexible Ringing Assignment —Day/Night/Lunch

Determines which extension(s) will ring for incoming outside calls in the day, night and/or lunch modes.

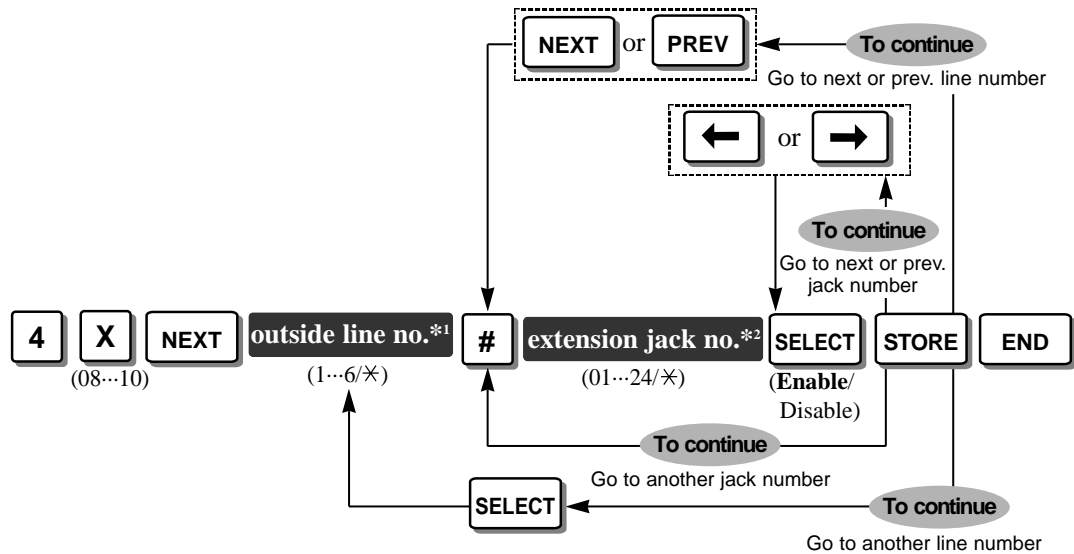

X – Program address selection number: 08 ([408] for day) / 09 ([409] for night) / 10 ([410] for lunch)

*1 Outside (CO) line number: 1 through 6 / * (All outside lines)

*2 Extension jack number: 01 through 24 / * (All extension jacks)

Default All outside (CO) lines – all extension jacks – Enable



• **Feature References**

Section 3, Features

Outside (CO) Line Ringing Selection, Uniform Call Distribution (UCD), Receiving Calls

[411]-[413] Delayed Ringing Assignment —Day/Night/Lunch

Assigns the ringing start time for extension(s) which were selected to ring in programs [408]-[410] “Flexible Ringing Assignment —Day/Night/Lunch” in the day, night and/or lunch modes.

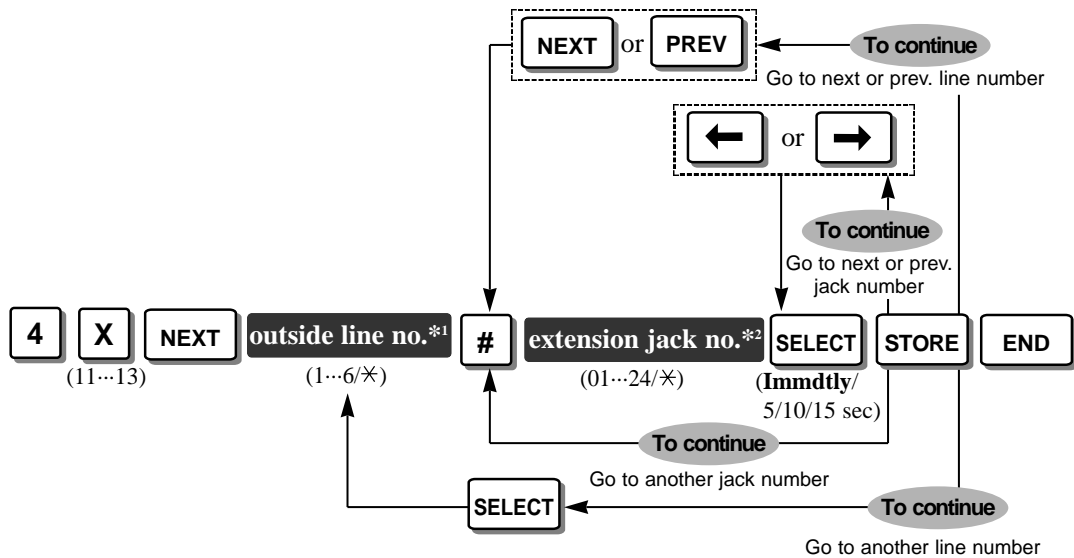

X – Program address selection number: 11 ([411] for day) / 12 ([412] for night) / 13 ([413] for lunch)

*1 Outside (CO) line number: 1 through 6 / * (All outside lines)

*2 Extension jack number: 01 through 24 / * (All extension jacks)

Default All outside (CO) lines – all extension jacks – Immediately



- **Feature Reference**
Section 3, Features
Receiving Calls

[414]-[416] Outside (CO) Line Mode —Day/Night/Lunch

Selects the mode of an incoming outside call on each outside (CO) line in the day, night and lunch modes. There are the following 5 modes.

- Normal:** An incoming outside call will be received at the extension(s) assigned in programs [408]–[410] “Flexible Ringing Assignment — Day/Night/Lunch”.
- DIL:** An incoming outside call will be received at the assigned extension in this program.
- DISA1:** An incoming outside call will be received at an extension through the DISA feature. A caller will hear a tone or an outgoing message.
- DISA2:** An incoming outside call will be received at an extension through the DISA feature. A caller might hear OGM 2; for various configurations please see Cases 2, 3 and 4 in Section 3, Features “Outgoing Message (OGM)”.
- UCD:** An incoming outside call will be received at an extension through the UCD feature.

< To select Normal, DISA or UCD >

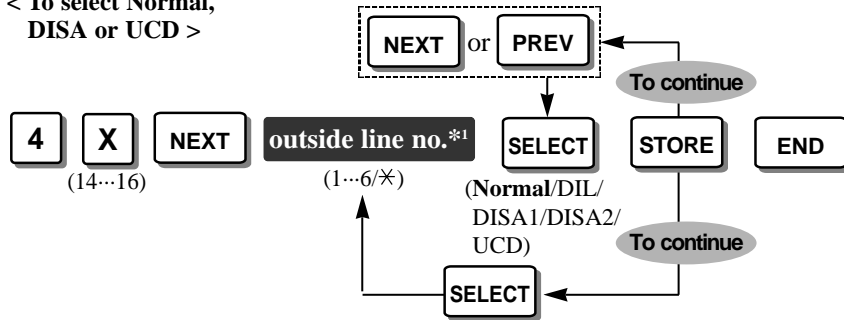

< To select DIL >

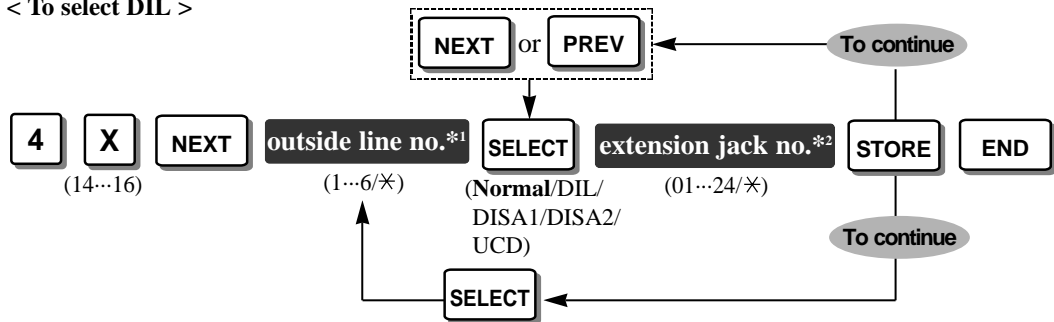

X – Program address selection number: 14 ([414] for day) / 15 ([415] for night) / 16 ([416] for lunch)

*1 Outside (CO) line number: 1 through 6 / * (All outside lines)

*2 Extension jack number: 01 through 24 / * (All extension jacks)

Default All outside (CO) lines – Normal

- ! You must select “DISA1” when the optional OGM/FAX Detection card is not installed and if you want to use the internal DISA.
- When you select “UCD”, assign program [520] “UCD Group” to determine which extension group is assigned to the UCD group.
- When you select “DISA1”, “DISA2” and/or “UCD”, assign program [502] “OGM Mode Selection” to determine which OGM will be used.



• **Feature References**

Section 3, Features

Direct In Line (DIL), Direct Inward System Access (DISA),
Outgoing Message (OGM), Uniform Call Distribution (UCD)

[417] *Pause Time*

Assigns the length of the pause time. The programmed pause time is automatically inserted after a line access code, a host PBX access code programmed in [403] “Host PBX Access Codes” or a pause code assigned in [311] “Automatic Pause Insertion Codes” or can be manually inserted by the user using the PAUSE button.

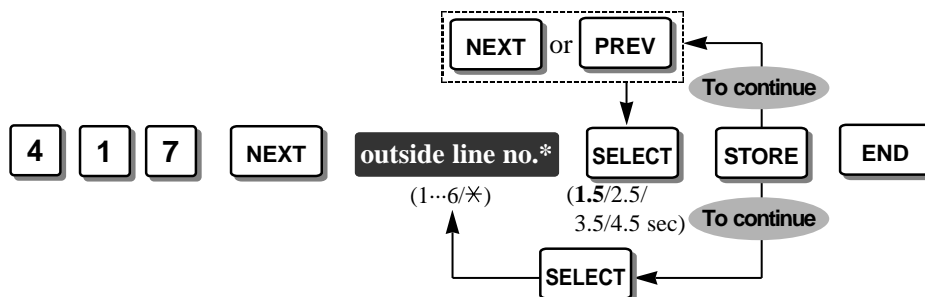

* Outside (CO) line number: 1 through 6 / * (All outside lines)

Default All outside (CO) lines – 1.5 seconds



• **Feature Reference**

Section 3, Features

Host PBX Access

[418] Flash Time

Assigns the length of the flash time. If your system is installed behind a host PBX, External Feature Access is necessary to obtain its services. To enable it, select the required flash signal sending time for an outside (CO) line.

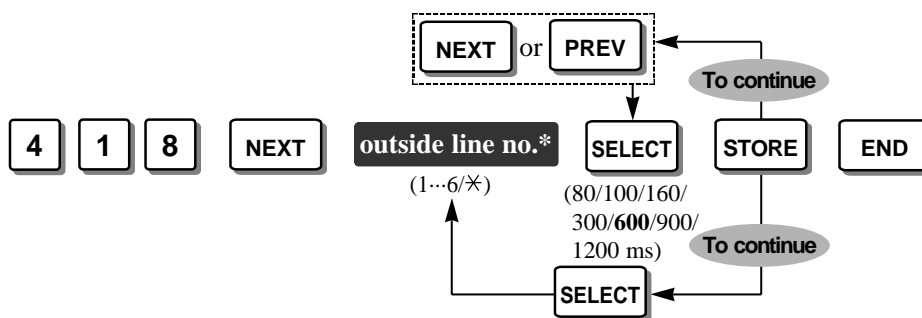

* Outside (CO) line number: 1 through 6 / * (All outside lines)

Default All outside (CO) lines – 600 milliseconds



- **Feature References**
Section 3, Features
External Feature Access, Flash

[419] Automatic Designated Outside (CO) Line Access

Selects which outside (CO) line can be seized automatically when an extension user dials the Automatic Line Access number (9 or 0) assigned in program [121] “Automatic Outside (CO) Line Access Number Selection”.

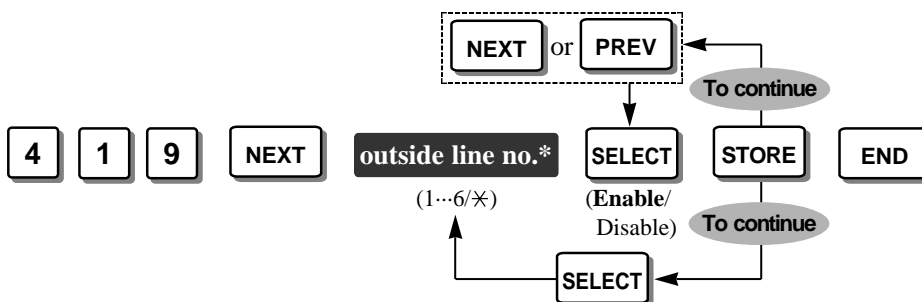

* Outside (CO) line number: 1 through 6 / * (All outside lines)

Default All outside (CO) lines – Enable



- **Feature References**
Section 3, Features
Automatic Outside (CO) Line Access Number, Outside Calling

[420] Calling Party Control (CPC) Signal

Assigns the required minimum duration of the Calling Party Control (CPC) signal from the Central Office for incoming outside calls. If programmed, the system disconnects the line when the CPC signal is detected.

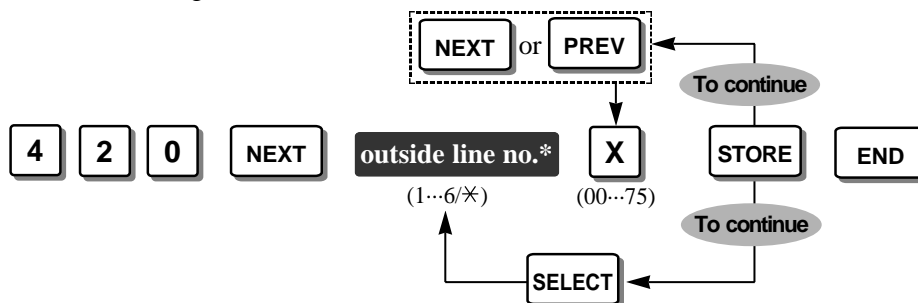

* Outside (CO) line number: 1 through 6 / * (All outside lines)

X – CPC signal detect time selection number: No. = selection number
Detect time (milliseconds)

No.	Detect time	No.	Detect time	No.	Detect time	No.	Detect time
00	Disable	19	166	38	318	57	470
01	22	20	174	39	326	58	478
02	30	21	182	40	334	59	486
03	38	22	190	41	342	60	494
04	46	23	198	42	350	61	502
05	54	24	206	43	358	62	510
06	62	25	214	44	366	63	518
07	70	26	222	45	374	64	526
08	78	27	230	46	382	65	534
09	86	28	238	47	390	66	542
10	94	29	246	48	398	67	550
11	102	30	254	49	406	68	558
12	110	31	262	50	414	69	566
13	118	32	270	51	422	70	574
14	126	33	278	52	430	71	582
15	134	34	286	53	438	72	590
16	142	35	294	54	446	73	598
17	150	36	302	55	454	74	606
18	158	37	310	56	462	75	614

Default All outside (CO) lines – Disable (No. 00)



• Feature Reference

Section 3, Features

Calling Party Control (CPC) Signal Detection

[421] CPC Detection for Outgoing Calls

Enables or disables the CPC signal detection during an outgoing outside call. If disabled, the CPC signal detection is only activated during an incoming outside call or after call hold.

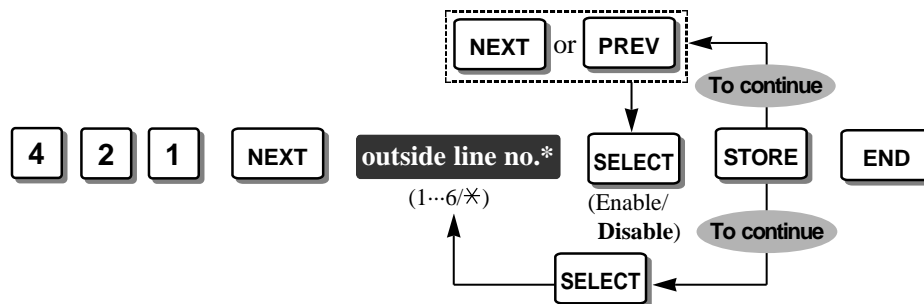

* Outside (CO) line number: 1 through 6 / * (All outside lines)

Default All outside (CO) lines – Disable



- **Feature Reference**
Section 3, Features
Calling Party Control (CPC) Signal Detection

[422] Disconnect Time

Determines the amount of time to send the disconnect signal from the system to the Central Office or host PBX. The time you select must be longer than the requirements of your Central Office or host PBX.

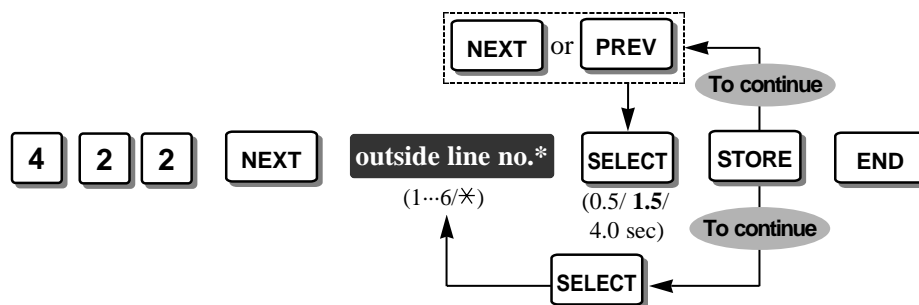

* Outside (CO) line number: 1 through 6 / * (All outside lines)

Default All outside (CO) lines – 1.5 seconds



- **Feature Reference**
Section 3, Features
Flash

[423] *Outside (CO) Line Ringing Pattern Selection*

Selects the incoming outside call ringing pattern, **Single**, **Double** or **Triple**, for each outside (CO) line. This is useful for distinguishing private calls from business calls.

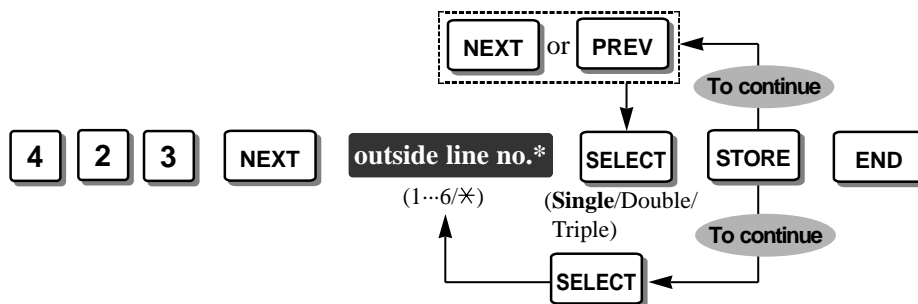
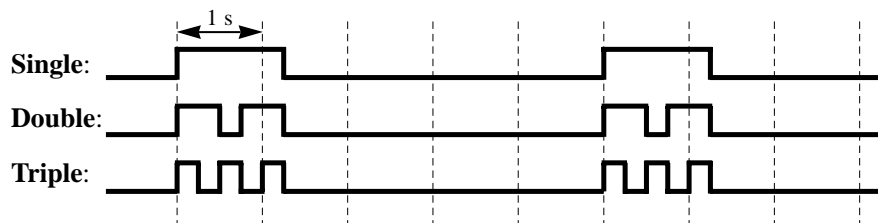

* Outside (CO) line number: 1 through 6 / * (All outside lines)

Default All outside (CO) lines – Single



- When selecting the ring pattern illustrated above, we recommend that other ring patterns of the system be considered. Namely, please consider the settings of [115] “Extension Ringing Pattern Selection”, and [706] “Doorphone Ringing / Tone Pattern Selection”.



- Feature Reference**
Section 3, Features
Ringing Pattern Selection

[424] Reverse (Polarity) Circuit Assignment

Enables or disables detecting the reverse signal for each outside (CO) line's polarity from the Central Office when making a call. If enabled, the outside call duration can be determined.

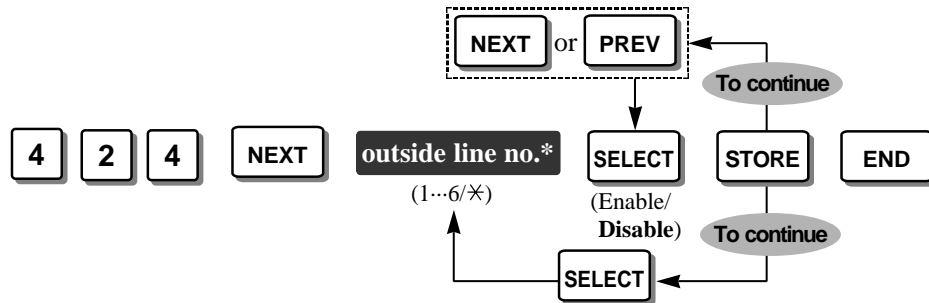

* Outside (CO) line number: 1 through 6 / * (All outside lines)

Default All outside (CO) lines – Disable



- **Feature Reference**
 Section 3, Features
 Polarity Reverse Detection

[500] DISA Incoming Dialing Mode Selection

Selects the destination of an incoming outside call via the DISA feature when you select “DISA 1” or “DISA 2” in programs [414]-[416] “Outside (CO) Line Mode –Day/Night/Lunch”, **Without AA** (auto attendant) or **With AA** . If you select “With AA”, assign the next program [501] “DISA Built-in Auto Attendant”.

Without AA: Available destinations are: extension numbers assigned in program [009] “Extension Number Assignment”, line access numbers (9 or 0, 81 through 86) and the operator number (0 or 9).

With AA: Available destinations are: numbers available in the “Without AA” mode, and numbers (0 through 9) assigned in program [501].

5 **0** **0** **NEXT** **SELECT** **STORE** **END**

(Without AA/
With AA)

Default Without AA



- For example: in the “With AA” mode, if a number is not dialed within the programmed time in [517] “DISA AA Wait Time” after dialing 1, the call is received at the DISA built-in auto attendant number 1.
- In the “With AA” mode, if 0 and/or 9 are not assigned in program [501], the system recognizes them as a line access number and/or operator number.



• **Feature Reference**

Section 3, Features

Direct Inward System Access (DISA)

[501] DISA Built-in Auto Attendant

Assigns a maximum of 10 DISA built-in auto attendant numbers when “With AA” is selected in program [500] “DISA Incoming Dialing Mode Selection”. The extension numbers assigned in program [009] “Extension Number Assignment”, and the extension group numbers assigned in program [600] “Extension Group Assignment” can be assigned as a 1 digit number and used as DISA built-in auto attendant numbers.

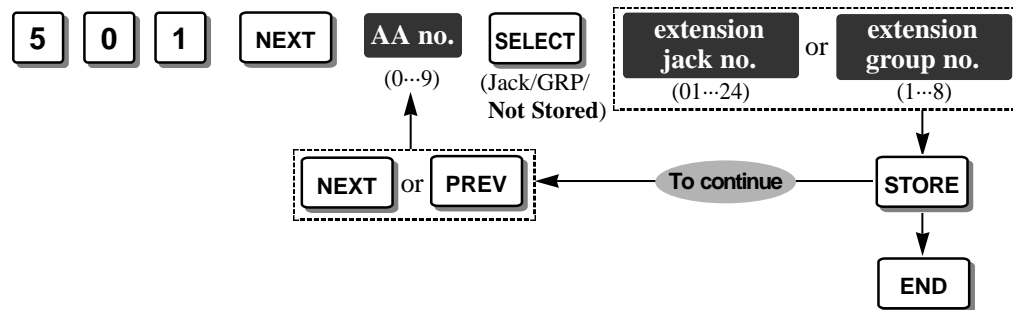

Default All auto attendant numbers – Not stored

! • If you would like to use a line access number and/or operator number in the “With AA” mode, do not assign auto attendant number(s) which correspond to a line access number and/or operator number (0 and/or 9).

☞ • **Feature Reference**
 Section 3, Features
 Direct Inward System Access (DISA)

[502] OGM Mode Selection

Selects how the 2 outgoing messages (OGM1 and OGM2) are used, **MODE1** through **MODE6**.

Mode	OGM1	OGM2	Description
1	DISA1	DISA1	The system can receive 2 incoming calls via the DISA feature at the same time. This is useful when receiving many calls.
2	DISA1	DISA2	An example: DISA1 is used in the day mode and DISA2 is used in the night mode.
3	UCD	UCD	The system can hold up to 2 incoming calls via the UCD feature at the same time until any extension is available.
4	UCD	UCD-END	The system disconnects an incoming call via the UCD feature when the assigned waiting time in [521] "UCD Busy Waiting Time" expires.
5	UCD	DISA1	An example: UCD is used in the day mode and DISA1 is used in the night mode.
6	UCD	DISA	The system leads an incoming call via the UCD feature to the DISA feature by OGM2 when the assigned waiting time in [521] "UCD Busy Waiting Time" expires and "Intercept" is selected in [523] "UCD Busy Mode".

(MODE 1/
2/3/4/5/6)

Default MODE1



- Programs [414]-[416] "Outside (CO) Line Mode – Day/Night/Lunch" are used to assign "DISA1", "DISA2" or "UCD" to each outside (CO) line according to this assignment.
- UCD-END is automatically used when "UCD" is assigned in programs [414]-[416], "Disconnect" is selected in program [523] "UCD Busy Mode", and "MODE4" is selected in this program.
- DISA is automatically used when "UCD" is assigned in programs [414]-[416], "Intercept" is selected in program [523], and "MODE6" is selected in this program.
- If the optional OGM/FAX Detection card is not installed, this assignment should be "MODE1".



• **Feature References**

Section 3, Features

Direct Inward System Access (DISA), Outgoing Message (OGM),
Uniform Call Distribution (UCD)

[503] FAX Connection *1

Assigns one extension which can receive facsimile data when the system receives a FAX (CNG) tone via the DISA feature.

5 **0** **3** **NEXT** **extension jack no.** **STORE** **END**
(01...24)

Default Disable (Not assigned)



- The assigned extension will automatically have the Data Line Security feature set.
- To unassign an extension jack number, press the CLEAR button in the extension jack number step.



- **Feature References**
Section 3, Features
Data Line Security, Direct Inward System Access (DISA)

[504] DISA Delayed Answer Time

Sets the time from a call being received and answered with the DISA feature.

5 **0** **4** **NEXT** **SELECT** **STORE** **END**
(0/3/6/12 sec)

Default 3 seconds



- **Feature Reference**
Section 3, Features
Direct Inward System Access (DISA)

[505] DISA Waiting Time after OGM *1

Assigns the length of time the system keeps detecting the DTMF signals or FAX (CNG) tone after the DISA outgoing message is completed.

5 **0** **5** **NEXT** **SELECT** **STORE** **END**
(0/5/10/15 sec)

Default 5 seconds



- **Feature Reference**
Section 3, Features
Direct Inward System Access (DISA)

*1: Required only when the optional OGM/FAX Detection Card is installed.

[506] DISA Busy Mode

Selects the operation when a called extension or all called extensions in an extension group enabled in program [100] “Hunting Group Set” via the DISA feature is/are busy.

Disconnect, Call Waiting or **DISA2** is available.

Disconnect: The call is disconnected after the busy tone.

Call Waiting: A call waiting tone is sent to the called extension or first called extension in the hunting group.

DISA2: OGM2 is sent to the caller and the system waits for another destination when the first destination is busy.



(Disconnect/
Call Waiting/
DISA2)

Default Disconnect



- Program [502] “OGM Mode Selection” should be “MODE2”, if “DISA2” was selected in this program.



• **Feature References**

Section 3, Features

Direct Inward System Access (DISA), Outgoing Message (OGM)

[507] DISA Intercept Mode

Selects the operation when a called extension or extension group via the DISA feature does not answer a call within the length of time programmed in [508] “DISA Ringing Time before Intercept”. **Intercept** or **Disconnect** is available.

Intercept: The call is redirected depending on [408]-[410] “Flexible Ringing Assignment–Day/Night/Lunch” (Intercept Routing – No Answer feature). This is useful for business use. For example, the call is forwarded to the operator or a Voice Processing System automatically.

Disconnect: The call is disconnected. This is useful for users who do not want to forward the call, for example, to a home.



(Intercept/
Disconnect)

Default Intercept



• **Feature References**

Section 3, Features

Direct Inward System Access (DISA), Intercept Routing,
Voice Mail Integration for KX-TVP75/KX-TVP100

[508] DISA Ringing Time before Intercept

Assigns the length of time for the Intercept Routing – No Answer feature (☞ [507] “DISA Intercept Mode”, Intercept). When the time expires the system starts to redirect the call to the programmed extension(s).

5 **0** **8** **NEXT** **SELECT** **STORE** **END**

(10/20/30/
40/60/120 sec)

Default 20 seconds



- **Feature References**

Section 3, Features

Direct Inward System Access (DISA), Intercept Routing

[509] DISA Ringing Time after Intercept

Assigns the length of time to call the extension(s) where a call is redirected by the Intercept Routing – No Answer feature (☞ [507] “DISA Intercept Mode”, Intercept) after the time programmed in [508] “DISA Ringing Time before Intercept” expires. If the call is not answered within the programmed time, the call will be disconnected.

5 **0** **9** **NEXT** **SELECT** **STORE** **END**

(10/20/30/
40/60/120 sec)

Default 20 seconds



- **Feature References**

Section 3, Features

Direct Inward System Access (DISA), Intercept Routing

[510] DISA No Dial Mode

Selects the operation when the system does not receive either DTMF signals or a FAX (CNG) tone after a programmed length of time. If the optional card is installed, then use program [505] "DISA Waiting Time after OGM". If the optional card is not installed, then use program [515] "Intercept Time for Internal DISA". **Intercept** or **Disconnect** is available.

Intercept: The call is directed depending on programs [408]-[410] "Flexible Ringing Assignment–Day/Night/Lunch" (Intercept Routing – No Answer feature). The destination telephone(s) will ring for the time programmed in [509] "DISA Ringing Time after Intercept".

Disconnect: The call is disconnected.

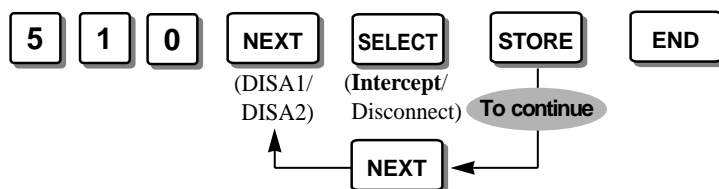

Default DISA 1 and DISA 2 – Intercept



- **Feature References**

Section 3, Features

Direct Inward System Access (DISA), Intercept Routing

[511] DISA Security Type

Selects the security mode for making calls attempted by a DISA caller. **Trunk Security** (outside (CO) line security), **All Security** or **None Security** is available.

Trunk Security: Requires the caller to enter a DISA security code assigned in program [512] "DISA Security Codes" before making an outside call.

All Security: Requires the caller to enter a DISA security code before making either an outside or intercom call.

None Security: Allows the caller to make both an outside and intercom call without entering a DISA security code.

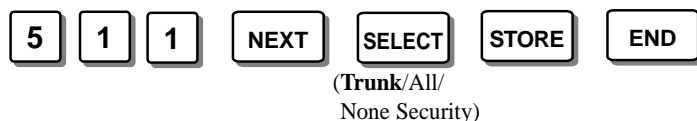

Default Trunk Security



- **Feature Reference**

Section 3, Features

Direct Inward System Access (DISA)

[512] DISA Security Codes

Assigns a maximum of 4 required DISA security codes if “Trunk Security” or “All Security” is selected in program [511] “DISA Security Type”.

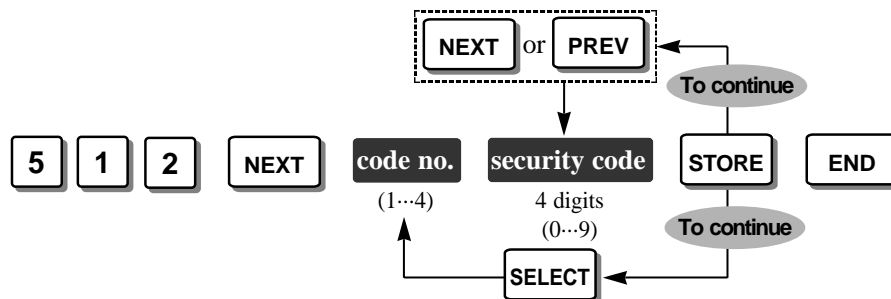

Default All DISA security codes – Not stored



- The used code numbers (not security codes) are printed on the SMDR.



- Feature Reference**
Section 3, Features
Direct Inward System Access (DISA)

[513] Cyclic Tone Detection*¹

Assigns the number of times a cyclic tone is detected while the DISA outgoing message is sent so that the system can recognize the end of the DISA call.



* Disable (Does not detect)

Default 4 Times



- Feature References**
Section 3, Features
Direct Inward System Access (DISA), Uniform Call Distribution (UCD)

*¹: Required only when the optional OGM/FAX Detection Card is installed.

[514] FAX Tone Detection*¹

Sets the number of times the FAX (CNG) tone must be detected while the DISA outgoing message is sent before the system recognizes the incoming signal as facsimile data.

5 **1** **4** **NEXT** **SELECT** **STORE** **END**
(1 Time/2 Times)

Default 1 Time



- The extension which can receive facsimile data must be assigned in program [503] "FAX Connection"



- **Feature Reference**
Section 3, Features
Direct Inward System Access (DISA)

[515] Intercept Time for Internal DISA

Assigns the length of time the system keeps detecting DTMF signals after a call is received at the internal DISA. If the system does not receive DTMF signals within the programmed time, the call will be intercepted or disconnected according to program [510] "DISA No Dial Mode".

5 **1** **5** **NEXT** **SELECT** **STORE** **END**
(3/6/9 sec)

Default 3 seconds



- A cyclic tone and FAX (CNG) tone cannot be detected by the internal DISA.



- **Feature Reference**
Section 3, Features
Direct Inward System Access (DISA)

[516] DISA Incoming Assignment

Enables or disables each extension to receive an outside call via the DISA feature. If a DISA call is received at a disabled extension, the DISA caller will hear a reorder tone and the call will be disconnected automatically. For example, it may be convenient to disable the president's extension.

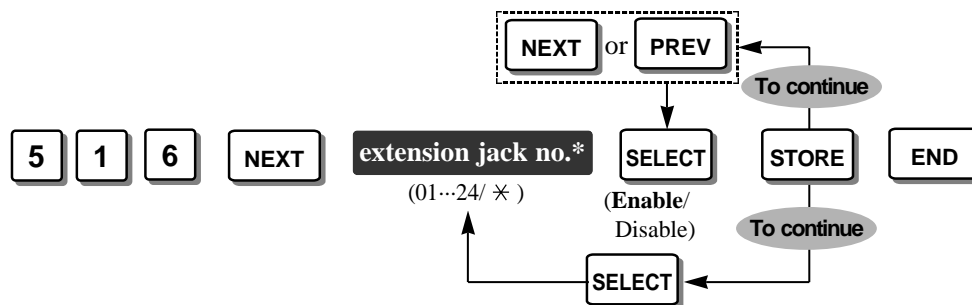

* Extension jack number: 01 through 24 / ✕ (All extension jacks)

Default All extension jacks – Enable



• If a call via the DISA feature is received by an extension group, this program will not work for extensions in that extension group. In this case, disabled extensions will still ring.



- **Feature Reference**
Section 3, Features
Direct Inward System Access (DISA)

[517] DISA AA Wait Time

Selects the time that the system waits for a second digit entry. If the programmed time expires, the system will assume that the first digit is a DISA built-in auto attendant number, if a number is assigned in program [501] “DISA Built-in Auto Attendant”. For example, if a number is not dialed within the programmed time after dialing 1, the system will assume that “1” is the auto attendant number.

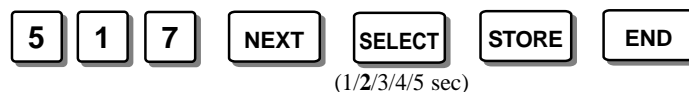

Default 2 seconds



- **Feature Reference**
Section 3, Features
Direct Inward System Access (DISA)

[518] DISA Tone Selection after the Security Code

Enables or disables sending a beep after entering the security code. If “Enable” is selected, a beep is sent when the number entered is the same as one of the security codes assigned in program [512] “DISA Security Codes”.



Default Enable



- **Feature Reference**
Section 3, Features
Direct Inward System Access (DISA)

[519] DISA OGM Mute Time

Assigns the length of time from answering a call with the DISA feature and sending the DISA outgoing message or a beep. During the assigned length of time, the system will not receive DTMF signals.

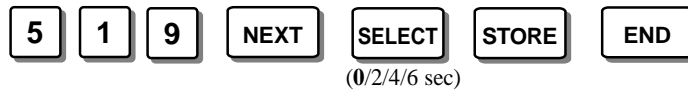

Default 0 second



- **Feature Reference**
Section 3, Features
Direct Inward System Access (DISA)

[520] UCD Group*¹

Assigns one extension group which works as the UCD group.

5 2 0 NEXT extension group no. STORE END
(1...8)

Default Extension group number 1



- **Feature Reference**
Section 3, Features
Uniform Call Distribution (UCD)

[521] UCD Busy Waiting Time*¹

Assigns the length of time the system holds an incoming outside call via the UCD feature when all extensions in the UCD group are busy. When the programmed time expires, the call will be intercepted or disconnected according to program [523] "UCD Busy Mode".

5 2 1 NEXT waiting time* SELECT STORE END
(min/sec)

* Waiting time: 1 through 32 (minutes) / 1 through 59 (seconds)

Default 10 minutes



- **Feature Reference**
Section 3, Features
Uniform Call Distribution (UCD)

[522] UCD OGM Message Interval Time*¹

Assigns interval time between sending UCD outgoing messages to an incoming outside call via the UCD feature when all extensions in the UCD group are busy. The UCD outgoing message is repeated during the time programmed in [521] "UCD Busy Waiting Time".

5 2 2 NEXT SELECT STORE END
(30 sec/1/
1.5/2 min)

Default 1 minute



- **Feature Reference**
Section 3, Features
Uniform Call Distribution (UCD)

*¹: Required only when the optional OGM/FAX Detection Card is installed.

[523] UCD Busy Mode*¹

Selects the operation when the length of time programmed in [521] “UCD Busy Waiting Time” expires. **Intercept** or **Disconnect** is available.

Intercept: The call will be redirected depending on programs [408]-[410] “Flexible Ringing Assignment–Day/Night/Lunch” (Intercept Routing feature). The extension which receives a redirected call rings during the length of time programmed in [526] “UCD Ringing Time after Intercept”.

Disconnect: The call will be disconnected immediately.



(Intercept/
Disconnect)

Default Intercept



- The above-mentioned intercept is only occurs when “MODE 3” or “MODE 5” is selected in program [502] “OGM Mode Selection”. If “MODE 4” is selected, the call will be disconnected after the UCD-END outgoing message. If “MODE 6” is selected and “Intercept” is assigned in this program, the call will be led to the DISA feature by OGM2.



• **Feature References**

Section 3, Features

Intercept Routing, Uniform Call Distribution (UCD)

[524] UCD Intercept Mode*¹

Selects the operation when all extensions in the UCD group do not answer an outside call via the UCD feature within the length of time programmed in [525] “UCD Ringing Time before Intercept”. **Intercept** or **Disconnect** is available.

Intercept: The call is redirected depending on programs [408]-[410] “Flexible Ringing Assignment–Day/Night/Lunch” (Intercept Routing – No Answer feature).

Disconnect: The call is disconnected.



(Intercept/
Disconnect)

Default Intercept



• **Feature References**

Section 3, Features

Intercept Routing, Uniform Call Distribution (UCD)

[525] UCD Ringing Time before Intercept*¹

Assigns the length of time for the Intercept Routing – No Answer feature (☞ [524] “UCD Intercept Mode”, Intercept). When the time expires, the system starts to redirect the call to the programmed extension(s).

5 **2** **5** **NEXT** **SELECT** **STORE** **END**

(10/20/30/
40/60/120 sec)

Default 20 seconds



- **Feature References**
Section 3, Features
Intercept Routing, Uniform Call Distribution (UCD)

[526] UCD Ringing Time after Intercept*¹

Assigns the length of time to call the extension(s) where a call is redirected by the Intercept Routing – No Answer feature (☞ [524] “UCD Intercept Mode”, Intercept) after the time programmed in [525] “UCD Ringing Time before Intercept” expires.

5 **2** **6** **NEXT** **SELECT** **STORE** **END**

(10/20/30/
40/60/120 sec)

Default 20 seconds



- **Feature References**
Section 3, Features
Intercept Routing, Uniform Call Distribution (UCD)

*¹: Required only when the optional OGM/FAX Detection Card is installed.

[600] Extension Group Assignment

Assigns an extension group for each extension. For example: by department or floor.

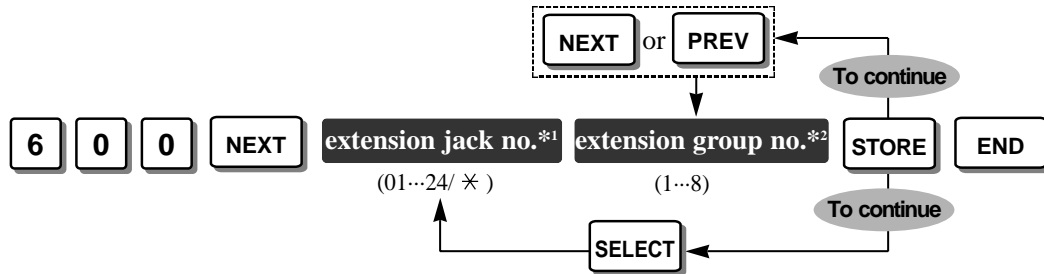

*1 Extension jack number: 01 through 24 / * (All extension jacks)

*2 Extension group number: 1 through 8

Default All extension jacks – Extension group 1



• Every extension should belong to an extension group, but cannot belong to more than one group.



• **Feature References**
Section 3, Features
Extension Group, Station Hunting

[601]-[603] TRS – Class of Service Assignment —Day/Night/Lunch

Programs a class of service (COS) in the day, night and/or lunch modes for each extension. There are 5 class of services available for each extension.

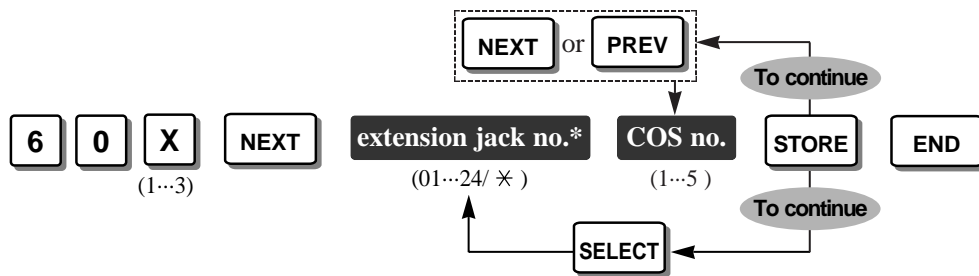

X – Program address selection number: 1 ([601] for day) / 2 ([602] for night) / 3 ([603] for lunch)

* Extension jack number: 01 through 24 / * (All extension jacks)

Default All extension jacks – COS-1



• **Feature Reference**
Section 3, Features
Toll Restriction

[604] Extension Name Setting

Assigns a name to each extension which will be displayed when making or receiving an intercom call.

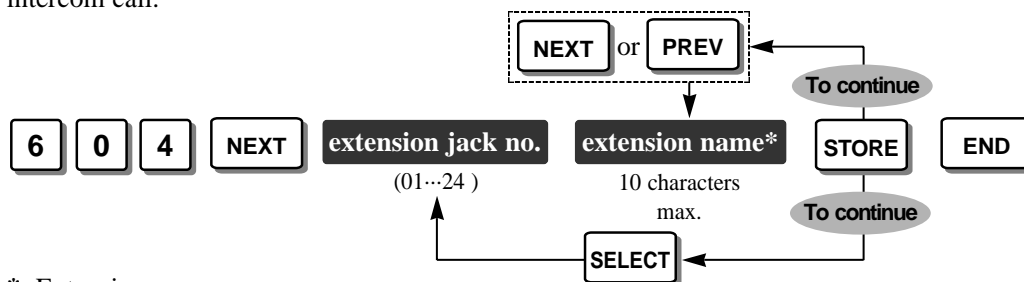

* Extension name:
Combination Table

Keys \ Pressing SELECT (Times)	Pressing SELECT (Times)							
	0	1	2	3	4	5	6	
1	1	Q	q	Z	z	!	?	
2	2	A	a	B	b	C	c	
3	3	D	d	E	e	F	f	
4	4	G	g	H	h	I	i	
5	5	J	j	K	k	L	l	
6	6	M	m	N	n	O	o	
7	7	P	p	R	r	S	s	
8	8	T	t	U	u	V	v	
9	9	W	w	X	x	Y	y	
0	0		.	,	'	:	;	
*	*	"	+	-	=	<	>	
#	#	\$	%	&	@	()	

<Example>

— To enter “Mike”;

1. Press 6 and then press the SELECT button once to enter “M”.
2. Press 4 and then press the SELECT button 6 times to enter “i”.
3. Press 5 and then press the SELECT button 4 times to enter “k”.
4. Press 3 and then press the SELECT button 4 times to enter “e”.

Default All extension jacks – Not stored.



- To erase all letters, press the CLEAR button. To erase 1 letter, press .
- Each name has a maximum of 10 characters.



- **Feature References**
Section 3, Features
Intercom Calling

[605] Account Code Entry Mode

Selects the account code input mode, **Option**, **Forced**, **Verify-All** or **Verify-Toll**, for each extension jack. This feature displays the account code of the called or calling party on the SMDR.

- Option:** The user can enter any account code, if needed.
- Forced:** The user must always enter an account code. The code can be any number.
- Verify-All:** The user must always enter an assigned account code in program [310] "Account Codes" to make an outside call.
- Verify-Toll:** The user can enter an assigned account code in program [310] to override toll restriction. The toll restriction COS numbers 3 through 5 will be changed temporarily to the COS number 2. (The COS numbers 1 and 2 will not be changed.)

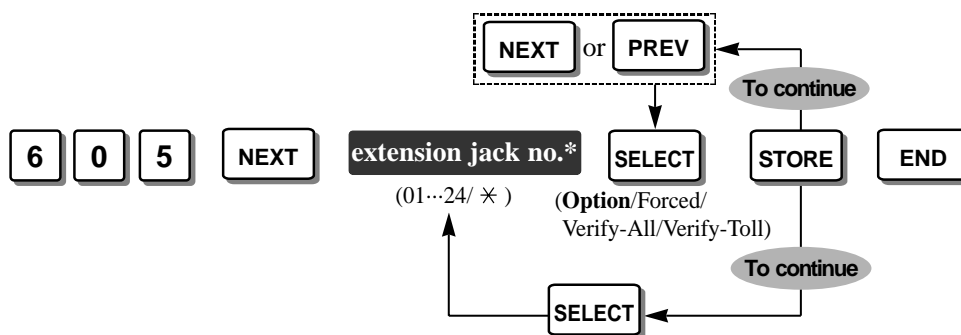

* Extension jack number: 01 through 24 / * (All extension jacks)

Default All extension jacks – Option



• **Feature References**

Section 3, Features

Account Code Entry, Toll Restriction Override by Account Codes

[606] Call Transfer to an Outside (CO) Line

Enables or disables transferring an intercom or outside call to any outside (CO) line manually for each extension.

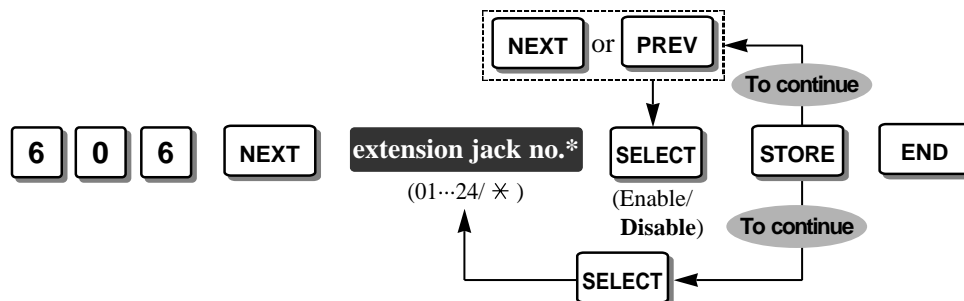

* Extension jack number: 01 through 24 / * (All extension jacks)

Default All extension jacks – Disable



- **Feature References**
 Section 3, Features
 Call Transfer – to Outside (CO) Line, Conference (3-party)

[607] Call Forwarding to an Outside (CO) Line

Enables or disables automatically forwarding an incoming intercom or outside call to any outside (CO) line for each extension.

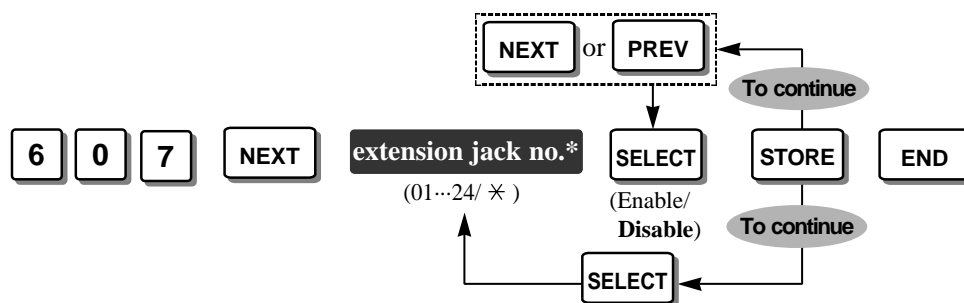

* Extension jack number: 01 through 24 / * (All extension jacks)

Default All extension jacks – Disable



- **Feature Reference**
 Section 3, Features
 Call Forwarding

[608] Executive Busy Override

Enables or disables using the Executive Busy Override feature at each extension. If enabled, an extension user can interrupt an established call.

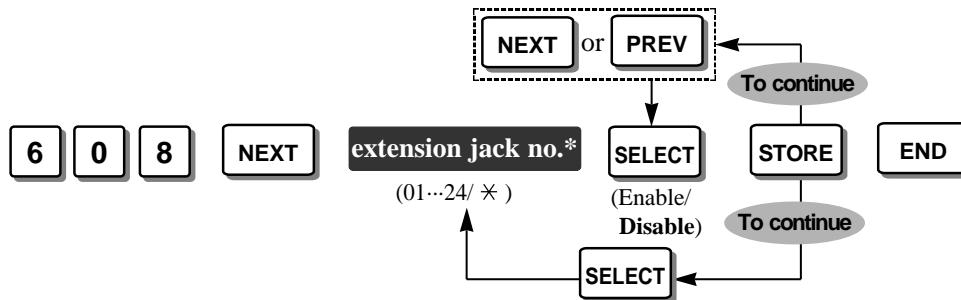

* Extension jack number: 01 through 24 / * (All extension jacks)

Default All extension jacks – Disable



- **Feature Reference**
Section 3, Features
Executive Busy Override

[609] Do Not Disturb Override

Enables or disables using the Do Not Disturb Override feature at each extension. If enabled, an extension user can ring an extension which has set the Do Not Disturb feature.

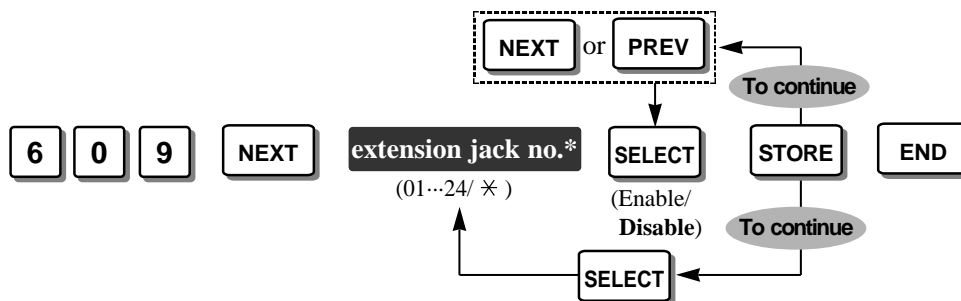

* Extension jack number: 01 through 24 / * (All extension jacks)

Default All extension jacks – Disable



- **Feature Reference**
Section 3, Features
Do Not Disturb (DND)

[610] Paralleled Telephone Connection

Enables or disables a single line telephone (SLT) to be connected in parallel with a proprietary telephone.

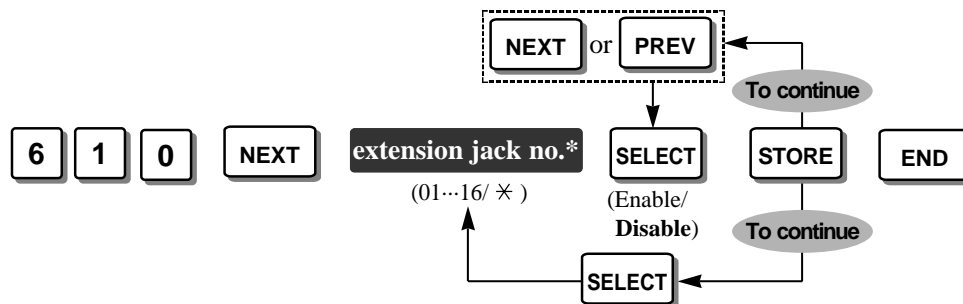

* Extension jack number: 01 through 16 / * (All extension jacks)

Default All extension jacks – Disable



- **Feature Reference**
Section 3, Features
Paralleled Telephone Connection

[611] TAM (Telephone Answering Machine) Extension

Assigns the jack number of an extension connected to a telephone answering machine (TAM) to activate the Call Retrieving from TAM feature.

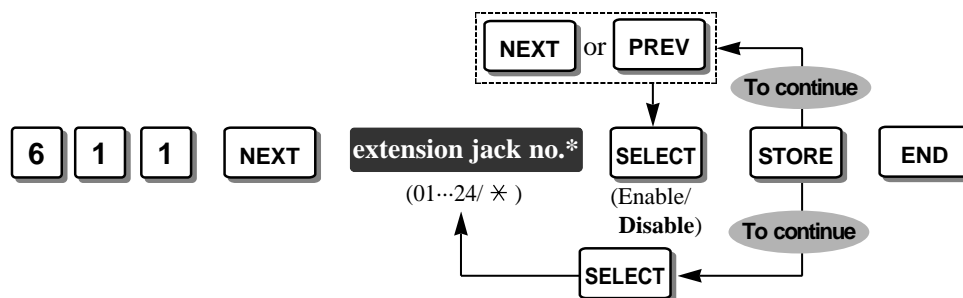

* Extension jack number: 01 through 24 / * (All extension jacks)

Default All extension jacks – Disable (not connected)



- **Feature Reference**
Section 3, Features
Call Pickup

[612] Room Monitor Assignment

Enables or disables which extension(s) can be monitored using the Room Monitor feature.

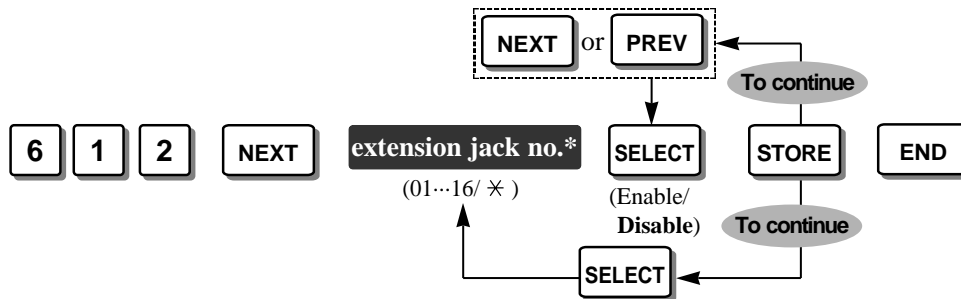

* Extension jack number: 01 through 16 / * (All extension jacks)

Default All extension jacks – Disable (Cannot be monitored.)



- **Feature Reference**
Section 3, Features
Room Monitor

[613] Outside (CO) Line Duration Time Limit Selection

Enables or disables the time limit programmed in [212] “Outside (CO) Line Duration Time Limit” for each extension.

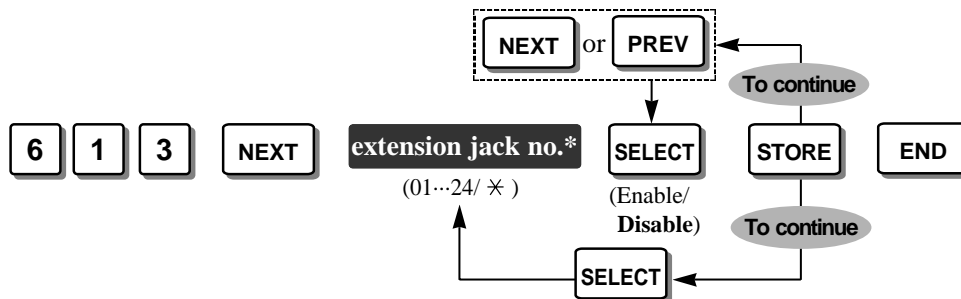

* Extension jack number: 01 through 24 / * (All extension jacks)

Default All extension jacks – Disable



- **Feature Reference**
Section 3, Features
Limited Call Duration

[614] Internal Pulse Detection

Enables or disables connecting a single line telephone (SLT) to receive pulse signals for each extension.

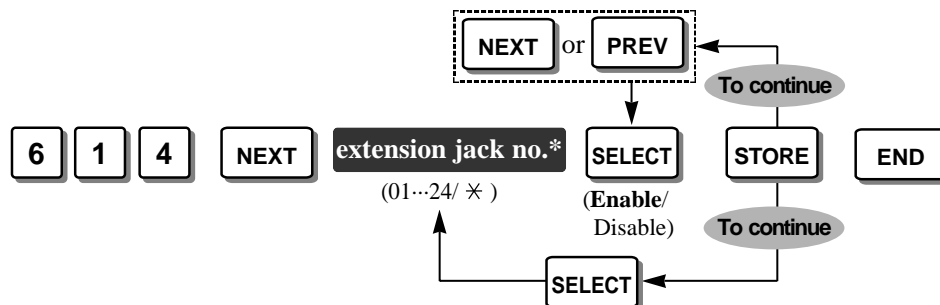

* Extension jack number: 01 through 24 / * (All extension jacks)

Default All extension jacks – Enable



- If you select “MODE 1” in program [207] “Hookswitch Flash Timing Range Selection” and “Enable” in this program, the system will distinguish between a pulse signal and hooking depending on the situation. When you select “Disable” in this program, if “1” is dialed during the pulse mode, the system will regard it as hooking and all other numbers will be disregarded.



- **Feature Reference**
Section 3, Features
Hookswitch Flash

[615] LCD Language Assignment

Selects the language, **English** or **Spanish**, shown on the LCD display of a proprietary telephone on an extension basis. The selected language is shown during operation and Proprietary Telephone Settings.

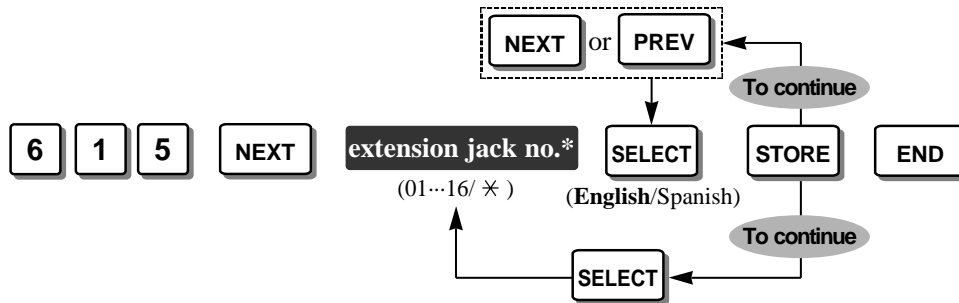

* Extension jack number: 01 through 16 / * (All extension jacks)

Default All extension jacks – English



The language used for the SMDR printout is assigned in program [806] “SMDR Language Assignment”.



Feature Reference
Section 3, Features
Language Selection

[700]-[702] Doorphone Ringing Assignment—Day/Night/Lunch

Enables or disables receiving a call from up to 4 doorphones in the day, night and/or lunch modes for each extension.

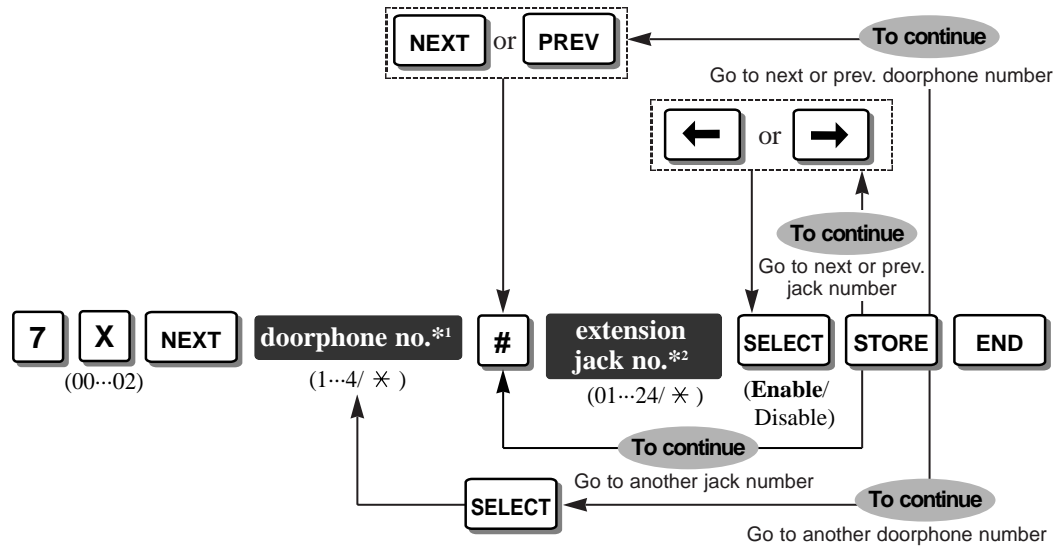

X – Program address selection number: 00 ([700] for day) / 01 ([701] for night) / 02 ([702] for lunch)

*1 Doorphone number: 1 through 4 / * (All doorphones)

*2 Extension jack number: 01 through 24 / * (All extension jacks)

Default All doorphones – all extension jacks – Enable



• **Feature Reference**

Section 3, Features

Doorphone Call

[703]-[705] Door Opener Assignment—Day/Night/Lunch

Enables or disables accessing to up to 4 door openers in the day, night and/or lunch modes for each extension.

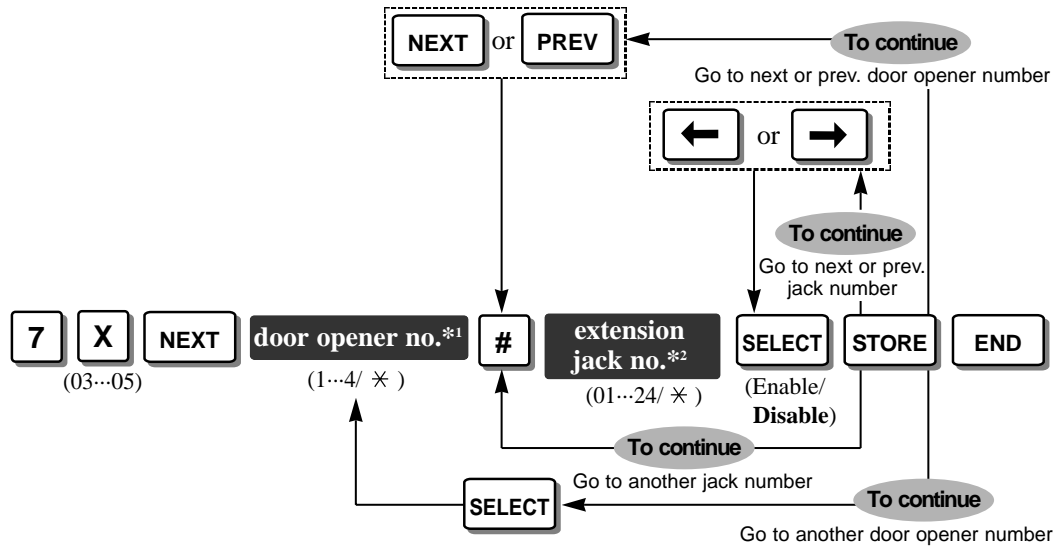

X – Program address selection number: 03 ([703] for day) / 04 ([704] for night) / 05 ([705] for lunch)

*1 Door opener number: 1 through 4 / * (All door openers)

*2 Extension jack number: 01 through 24 / * (All extension jacks)

Default All door openers – all extension jacks – Disable



- **Feature Reference**
- Section 3, Features
- Door Opener

[706] Doorphone Ringing / Tone Pattern Selection

Selects the doorphone ringing pattern, **Single**, **Double**, **Triple** or **S-Double**.

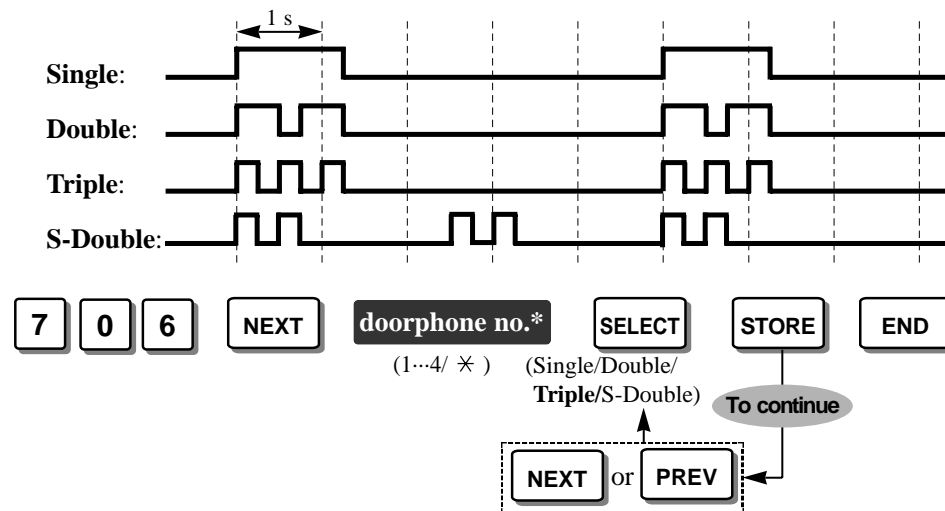

* Doorphone number: 1 through 4 / * (All doorphones)

Default All doorphones – Triple



- When a doorphone call is received at a proprietary telephone, a tone is heard instead of ringing.



- **Feature References**
Section 3, Features
Doorphone Call, Ringing Pattern Selection

[707] Doorphone Access Tone Selection

Enables or disables sending a doorphone access tone to a monitored doorphone. If enabled, the access tone is heard from the doorphone when monitoring from a telephone starts.

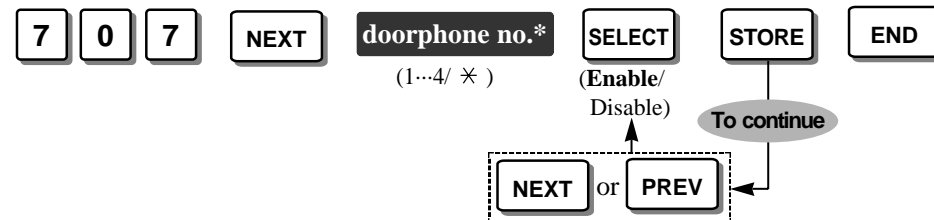

* Doorphone number: 1 through 4 / * (All doorphones)

Default All doorphones – Enable



- **Feature References**
Section 3, Features
Doorphone Call, Room Monitor

[708] Doorphone Ringing Time

Sets the ringing time when making an intercom call from a doorphone.

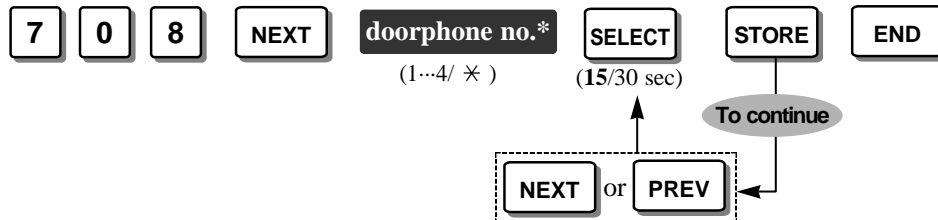

* Doorphone number: 1 through 4 / * (All doorphones)

Default All doorphones – 15 seconds



- **Feature Reference**
Section 3, Features
Doorphone Call

[709] Door Opener Time

Assigns the length of the door opener time. The door is unlocked for the assigned period of time.



* Door opener number: 1 through 4 / * (All door openers)

Default All door openers – 5 seconds



- **Feature Reference**
Section 3, Features
Door Opener

[800] SMDR RS-232C Communication Parameters

Assigns the communication parameters for the Serial Interface (RS-232C).

- NL-Code:** (New line) Selects the code for your printer or personal computer. If your printer or personal computer automatically feeds lines with a carriage return, select "CR". If not, select "CR+LF".
- Baud Rate:** The baud rate code indicates the data transmission speed from the system to the printer or personal computer.
- Word Length:** The word length code indicates how many bits compose a character.
- Parity:** The parity code indicates what type of parity is used to detect an error in the string of bits composing a character. Make your selection depending on the requirements of your printer or personal computer.
- Stop Bit:** The stop bit code indicates the end of a bit string which composes a character. Select a value depending on the requirements of your printer or personal computer.

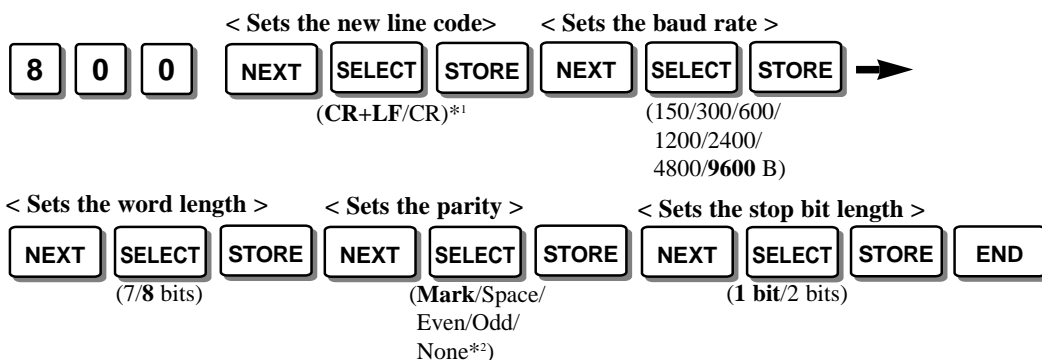

*1 CR+LF (Carriage Return + Line Feed) / CR (Carriage Return)
 *2 Select "None" when the error checking function is not required from the printer.

Default	New line	Baud rate	Word length	Parity	Stop bit length
	CR + LF	9600 baud	8 bits	Mark	1 bit

- ! To return to the previous mode, press **PREV** instead of **NEXT**.
- The following combinations are invalid.

Parity	Word length	Stop bit length
Mark	8	2
Space	8	1
Space	8	2

If any of the above invalid combinations are selected, an alarm tone is heard.



- **Feature Reference**
Section 3, Features
 Station Message Detail Recording (SMDR)

[801] SMDR Parameter

Assigns the following 2 printing parameters to match the SMDR output with the paper size used in the printer.

Page Length: Sets the number of lines per page.

Skip Perf: Sets the number of lines to be skipped at the end of every page.
(Perforation)

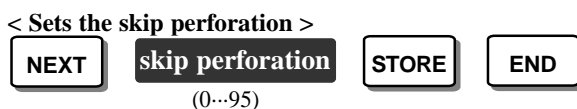
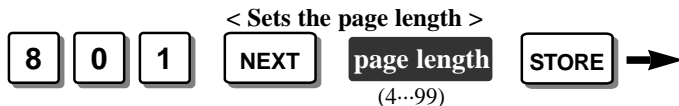

Default Page length – 66 lines
Skip perforation – 0 line



- The page length should be at least 4 lines longer than the skip perforation length.
- To correct a wrong entry, press the CLEAR button and enter the new one.



- **Feature Reference**
Section 3, Features
Station Message Detail Recording (SMDR)

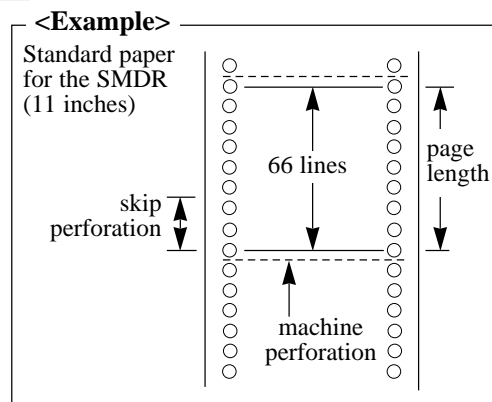

[802] Incoming/Outgoing Call Selection for Printing

Determines which calls will produce an SMDR printout.



*1 Outgoing: On (Print all calls) / Off (No printing) / Toll (Print toll calls only)

*2 Incoming: On (Print all calls) / Off (No printing)

Default Outgoing calls / Incoming calls – On



- If “Outgoing; Toll” is selected, only calls which are checked in programs [302]–[305] “Toll Restriction – Classes 2 through 5 Denied Codes” and are allowed, are printed out.



- **Feature Reference**
Section 3, Features
Station Message Detail Recording (SMDR)

[803] Secret Speed Dialing / One-Touch Dialing Printing

Selects to print or not print (on SMDR) secret dialing numbers stored in program [001] "System Speed Dialing Entry" and/or stored in One-Touch Dialing even though they are not displayed on the LCD.



(No Printing/
Printing)

Default No printing



• **Feature References**

Section 3, Features

Secret Dialing, Station Message Detail Recording (SMDR)

[804] System Data Dump

Starts and stops printing the assigned data. All or a specific area of current system-programmed data is printed out. The areas are as follows.

All Para: Prints out all data.

System Para: Prints out all data except for the following 4 parameters.

CO Para: Prints out programs [400] through [403] and [405] through [424].

Ext Para: If the extension is a proprietary telephone, programs [102], [516] [600] through [613] and [615] will be printed out. The assigned data on the PF (Programmable Feature) buttons and CO buttons will also be printed out. If the extension is a single line telephone, programs [102], [516] and [600] through [614] will be printed out. The assigned Personal Speed Dialing numbers are also printed out.

DSS Para: Prints out the assigned data in the DSS buttons and PF buttons on the DSS console.

Speed Dial: Prints out the System Speed Dialing numbers (00 through 99) and names (16 characters max.) assigned in programs [001] and [011].

Stop Output : Stops printing.

< To select All parameters, System parameter,
Speed dial and/or Stop output. >



(All/System/CO/Ext/
DSS Para/Speed Dial/
Stop Output)

To continue



< To select the CO (outside line) parameter. >

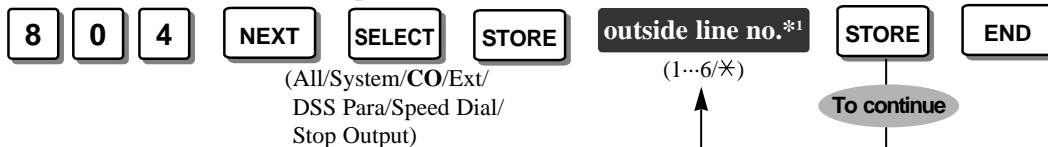

< To select the Extension parameter. >



< To select the DSS parameter. >



*1 Outside (CO) line number: 1 through 6 / * (All outside lines)

*2 Extension jack number: 01 through 24 / * (All extension jacks)

*3 DSS console number: 1 through 2 / * (Both DSS console numbers)



• This program and [999] “System Data Clear” are not included.



• **Feature Reference**

Section 3, Features

Station Message Detail Recording (SMDR)

[805] SMDR Account Code Selection

Selects printing out the account code stored in program [310] “Account Codes”, or just the index of the account code on SMDR printout.



Default CODE



• The printing of the index of the account code only occurs if the extension user entered their account code in the “Verify-All” or “Verify-Toll” input mode as programmed in [605] “Account Code Entry Mode”.



• **Feature References**

Section 3, Features

Account Code Entry, Station Message Detail Recording (SMDR)

[806] SMDR Language Assignment

Selects the language, **English** or **Spanish**, used for an SMDR printout.

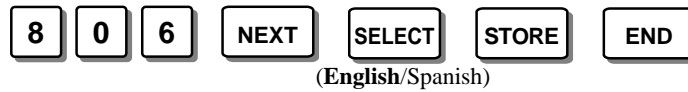

Default English



- **Feature References**

Section 3, Features

Language Selection, Station Message Detail Recording (SMDR)

[998] ROM Version

Confirms the system ROM version.



Display example:

Y501A 980430 (BX)
| |
Version Date

[999] System Data Clear

Resets all or a specific area of the current assigned data to the default settings. The areas are as follows.

- All Para :** Resets all data to the default settings.
- System Para:** Resets all data to the default settings except for the data of the following 4 parameters.
- CO Para:** Resets programs [400] through [403] and [405] through [424] to the default settings on an outside (CO) line basis.
- Ext Para:** Resets programs [102], [516] and [600] through [615] to the default settings on an extension basis.
- DSS Para:** Resets the assigned data on the DSS buttons and PF buttons on the DSS console.
- Speed Dial :** Resets the System Speed Dialing numbers (00 through 99) assigned in program [001].

< To select All, System parameter and/or Speed Dial. >

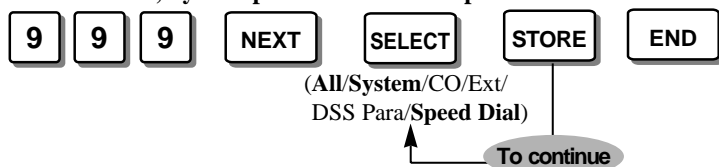

< To select the CO (outside line) parameter. >



< To select the Extension parameter. >



< To select the DSS parameter. >



*1 Outside (CO) line number: 1 through 6 / * (All outside lines)

*2 Extension jack number: 01 through 24 / * (All extension jacks)

*3 DSS console number: 1 through 2 / * (Both DSS console numbers)



- This program and [804] "System Data Dump" are not included.

• **Feature Reference**

Section 3, Features

System Data Default Set

Section 5
Appendix

5.1 *Default Values*

Address	Program	Default
[000]	Date and Time Setting	'98 Jan. 1 Thu 12:00 AM
[001]	System Speed Dialing Entry	All speed dialing numbers – Not stored
[002]	System Password	1234
[003]	DSS Console Port Assignment	All DSS Consoles — Disable
[004]	Paired Telephone Assignment for DSS Console	DSS1 – Disable, DSS2 – Disable
[005]	One-Touch Transfer Using a DSS Button	With Transfer
[006]	Time (Day/Night/Lunch) Service Changing Mode	Manual
[007]	Time (Day/Night/Lunch) Service Start Time	Every day of the week — Day – 9:00 AM / Night – 5:00 PM / Lunch-S – None / Lunch-E – None
[008]	Operator Assignment	Jack-01
[009]	Extension Number Assignment	Plan 1: Jacks 01 through 24 = Extn. 101 through 124
[010]	LCD Time Display Selection	12 HOUR
[011]	System Speed Dialing Name Setting	All System Speed Dialing numbers – Not stored
[012]	Second Feature Numbering Plan	All codes — Not stored
[100]	Hunting Group Set	All extension groups — Disable
[101]	Hunting Type	All extension groups – Terminate
[102]	Voice Mail Port for KX-TVP75/KX-TVP100	All 4 extension jacks — Disable
[103]	DTMF Integration for KX-TVP75/KX-TVP100	Disable
[104]	Hold Mode Selection	Hold-1
[105]	Conference Tone	Enable
[106]	External Paging Access Tone	Enable
[107]	DTMF Receiver Check	All DTMF receivers — Enable
[108]	Flash Mode for a Station Locked Extension	Disable
[109]	CO Indicator Assignment	Enable
[110]	Flash Key Mode	MODE 1
[111]	Hold Music Selection	Internal
[112]	DSS Console Indication Mode	Enable
[113]	Automatic Redial Repeat	10 times
[114]	Automatic Redial Interval Time	60 seconds
[115]	Extension Ringing Pattern Selection	Double
[116]	Conference Pattern Selection	5-party C-2 E-5

5.1 *Default Values*

Address	Program	Default
[117]	Call Pickup Tone	Enable
[118]	Pulse Restriction	Enable
[119]	Redialing after Pulse to Tone Conversion	Disable
[120]	Bell Frequency	25 Hz
[121]	Automatic Outside (CO) Line Access Number Selection	Dial 9
[122]	Automatic Rotation for Outside (CO) Line Access	Disable
[123]	Break Ratio	MODE 1
[124]	SLT Ringing Mode Selection	MODE 1
[125]	Toll Restriction Check for * and #	Enable
[126]	DSS Off-Hook Mode	Enable
[127]	Pickup Group Set	All extension groups – Disable
[200]	Hold Recall Time	30 seconds
[201]	Transfer Recall Time	30 seconds
[202]	Call Forwarding Start Time	15 seconds delay
[203]	Pickup Dial Delay Time	3 seconds
[204]	Call Duration Count Start Time	10 seconds after dialing
[205]	Outside-to-Outside (CO-to-CO) Line Duration Time Limit	10 minutes
[206]	Dialing Start Time	0 millisecond
[207]	Hookswitch Flash Timing Range Selection	MODE 4
[208]	Interdigit Time	10 seconds
[210]	DTMF Time	MODE 1
[211]	No Dial Disconnection	Disable
[212]	Outside (CO) Line Duration Time Limit	10 minutes
[213]	Bell Off Detection	6 seconds
[300]	Carrier Excepted Code Assignment	All codes – Not stored
[301]	Toll Restriction — System Speed Dialing Boundary Class	Boundary Class-1
[302]–[305]	Toll Restriction — Classes 2 through 5 Denied Codes	All codes – Not stored
[306]	Toll Restriction — Exception Codes	All codes – Not stored

5.1 *Default Values*

Address	Program	Default
[309]	Emergency Dial Number Set	All codes – Not stored
[310]	Account Codes	All codes – Not stored
[311]	Automatic Pause Insertion Codes	All codes – Not stored
[312]	Toll Restriction — Station Lock Boundary Class	Disable
[350]	ARS Selection	All outside (CO) lines – Disable
[351]–[354]	Routes 1 through 4 Selection Codes (Leading Digits)	All codes – Not stored
[355]–[358]	Routes 1 through 4 Exception Codes	All codes – Not stored
[359]	1st Carrier Selection Code	000
[360]	ARS Modification — Removed Digits	All routes – 0 (No deletion)
[361]	ARS Modification — Added Number	All routes – Not stored
[362]	ARS Dial Tone Pattern Selection	Tone 1
[363]	ARS Interdigit Time	5 seconds
[364]	ARS Outside (CO) Line Group	All routes – * (All outside line (TRK) groups)
[400]	Outside (CO) Line Connection Assignment	All outside (CO) lines – Connect
[401]	Dial Mode	All outside (CO) lines — Pulse Mode
[402]	Pulse Speed Selection	All outside (CO) lines – Low Speed
[403]	Host PBX Access Codes	All outside (CO) lines – Not stored
[404]	Outside (CO) Line Group Assignment	CO1 — TRK GRP-1; CO2 — TRK GRP-2; CO3 — TRK GRP-3; CO4 — TRK GRP-4; CO5 — TRK GRP-5; CO6 — TRK GRP-6;
[405]–[407]	Flexible Outward Dialing Assignment — Day/Night/Lunch	All outside (CO) lines – all extension jacks – Enable — Day/Night/Lunch
[408]–[410]	Flexible Ringing Assignment — Day/Night/Lunch	All outside (CO) lines – all extension jacks – Enable — Day/Night/Lunch
[411]–[413]	Delayed Ringing Assignment — Day/Night/Lunch	All outside (CO) lines – all extension jacks – Immdtly — Day/Night/Lunch
[414]–[416]	Outside (CO) Line Mode — Day/Night/Lunch	All outside (CO) lines — Normal — Day/Night/Lunch
[417]	Pause Time	All outside (CO) lines — 1.5 seconds
[418]	Flash Time	All outside (CO) lines – 600 milliseconds
[419]	Automatic Designated Outside (CO) Line Access	All outside (CO) lines — Enable

5.1 *Default Values*

Address	Program	Default
[420]	Calling Party Control (CPC) Signal	All outside (CO) lines – 00 (Disable)
[421]	CPC Detection for Outgoing Calls	All outside (CO) lines – Disable
[422]	Disconnect Time	All outside (CO) lines – 1.5 seconds
[423]	Outside (CO) Line Ringing Pattern Selection	All outside (CO) lines – Single
[424]	Reverse (Polarity) Circuit Assignment	All outside (CO) lines – Disable
[500]	DISA Incoming Dialing Mode Selection	Without AA
[501]	DISA Built-in Auto Attendant	All numbers — Not Stored
[502]	OGM Mode Selection	MODE 1
[503]	FAX Connection	Disable
[504]	DISA Delayed Answer Time	3 seconds
[505]	DISA Waiting Time after OGM	5 seconds
[506]	DISA Busy Mode	Disconnect
[507]	DISA Intercept Mode	Intercept
[508]	DISA Ringing Time before Intercept	20 seconds
[509]	DISA Ringing Time after Intercept	20 seconds
[510]	DISA No Dial Mode	DISA1 and DISA2 — Intercept
[511]	DISA Security Type	Trunk Security
[512]	DISA Security Codes	All DISA Security Codes – Not stored
[513]	Cyclic Tone Detection	4 Times
[514]	Fax Tone Detection	1 Time
[515]	Intercept Time for Internal DISA	3 seconds
[516]	DISA Incoming Assignment	All extension jacks — Enable
[517]	DISA AA Wait Time	2 seconds
[518]	DISA Tone Selection after the Security Code	Enable
[519]	DISA OGM Mute Time	0 second
[520]	UCD Group	Group – 1
[521]	UCD Busy Waiting Time	10 minutes
[522]	UCD OGM Message Interval Time	1 minute
[523]	UCD Busy Mode	Intercept
[524]	UCD Intercept Mode	Intercept
[525]	UCD Ringing Time before Intercept	20 seconds
[526]	UCD Ringing Time after Intercept	20 seconds

5.1 *Default Values*

Address	Program	Default
[600]	Extension Group Assignment	All extension jacks — EXT GRP-1
[601]–[603]	TRS – Class of Service Assignment — Day/Night/Lunch	All extension jacks — COS-1 — Day/Night/Lunch
[604]	Extension Name Setting	All extension jacks – Not stored
[605]	Account Code Entry Mode	All extension jacks – Option
[606]	Call Transfer to an Outside (CO) Line	All extension jacks – Disable
[607]	Call Forwarding to an Outside (CO) Line	All extension jacks – Disable
[608]	Executive Busy Override	All extension jacks – Disable
[609]	Do Not Disturb Override	All extension jacks – Disable
[610]	Paralleled Telephone Connection	All extension jacks – Disable
[611]	TAM (Telephone Answering Machine) Extension	All extension jacks – Disable
[612]	Room Monitor Assignment	All extension jacks – Disable
[613]	Outside (CO) Line Duration Time Limit Selection	All extension jacks – Disable
[614]	Internal Pulse Detection	All extension jacks – Enable
[615]	LCD Language Assignment	All extension jacks – English
[700]–[702]	Doorphone Ringing Assignment — Day/Night/Lunch	All doorphones — all extension jacks – Enable — Day/Night/Lunch
[703]–[705]	Door Opener Assignment — Day/Night/Lunch	All door openers – all extension jacks – Disable — Day/Night/Lunch
[706]	Doorphone Ringing/Tone Pattern Selection	All doorphones — Triple
[707]	Doorphone Access Tone Selection	All doorphones — Enable
[708]	Doorphone Ringing Time	All doorphones — 15 seconds
[709]	Door Opener Time	All door openers — 5 seconds
[800]	SMDR RS-232C Communication Parameters	New line code = CR+LF; Baud rate = 9600; Word length = 8; Parity = Mark; Stop bit = 1
[801]	SMDR Parameter	Page length – 66; Skip perforation – 0
[802]	Incoming/Outgoing Call Selection for Printing	Outgoing calls – On; Incoming calls – On
[803]	Secret Speed Dialing/One Touch Dialing Printing	No printing
[805]	SMDR Account Code Selection	CODE
[806]	SMDR Language Assignment	English

5.2 Specifications

System Capacity	KX-TA308	Outside (CO) Lines: 3 max. (6 max. with 3-CO Line & 8 Ext Expansion Card) Extensions : 8 max. (24 max. with 3-CO Line & 8 Ext Expansion Card and 8 SLT Extension Expansion Card)
	KX-TA616	Outside (CO) Lines: 6 max. Extensions : 16 max. (24 max. with 8 SLT Extension Expansion Card)
Control Method	CPU: 16 bit CPU Control ROM: 4 Mbit, Control RAM: 1 Mbit	
Switching	Space Division CMOS Crosspoint Switch	
Power Supplies	Primary: 110 V AC – 240 V AC, 50 Hz/60 Hz (1.0 A – 0.5 A) Secondary: Circuit Volt (+5 V, +26 V)	
Dialing	Dial Pulse (DP): 10 pps, 20 pps Tone (DTMF) Dialing, DTMF–DP	
Intercom Paths	4	
Connector	Outside (CO) Lines : 2-pin Modular Connector (RJ11) Extensions/Doorphone: 4-pin Modular Connector Pager/Music Source : EIAJ RC-6701 A plug (two-conductor, ϕ 3.5 mm in diameter)	
Extension Connection Cable	KX-T7320 / KX-T7330 / KX-T7350 / KX-T7020 / KX-T7030 / KX-T7033 / KX-T7050 / KX-T7055 / KX-T7130 2 pair wire (T, R, H, L) Single Line Telephones 1 pair wire (T, R)	
SMDR (Station Message Detail Recording)	Interface : Serial Interface (RS-232C) (D-SUB, 9-pin) Output Equipment: Printer Detail Recording : Date, Time, Extension Number, Outside (CO) Line Number, Dialed Number, Call Duration, Account Code	
Station Loop Limit	KX-T7320 / KX-T7330 / KX-T7350 / KX-T7020 / KX-T7030 / KX-T7033 / KX-T7050 / KX-T7055 / KX-T7130 40 Ω Single Line Telephones 600 Ω including set Doorphones 20 Ω	
Minimum Leakage Resistance	15 000 Ω	
Maximum Number of Station Instruments per Line	1 for a KX-T7320 / KX-T7330 / KX-T7350 / KX-T7020 / KX-T7030 / KX-T7033 / KX-T7050 / KX-T7055 / KX-T7130 or single line telephone 2 for by parallel connection of a proprietary telephone and a single line telephone	
Ring Voltage	80 Vrms at 25 Hz depending on the Ringing Load	
Central Office Loop Limit	1 600 Ω max.	
Environmental Requirements	0 °C – 40 °C {32 °F – 104 °F}, 10 % – 90 % relative humidity	
Hookswitch Flash Timing Range	80 ms – 1 000 ms	

5.2 *Specifications*

Lines, Cards, Station Equipment

Item	Max. Quantity
Service Units	1
Outside (CO) lines	6
Extension Jacks	24
Station Terminals	40
3-CO Line and 8 Ext Expansion Card	1 (KX-TA308 only)
8 SLT Extension Expansion Card	1
OGM/FAX Detection Card	1
Doorphone/Door Opener Card	1
Doorphones	4
Door Openers	4
External Pager	1
External Music Source	1
DSS Consoles	2

System Data

Item	Max. Quantity
Operator	1
System Speed Dialing	100
One Touch Dialing	24 per extension (Proprietary telephone)
Personal Speed Dialing	10 per extension
Call Park areas	10
Absent Messages	6
Toll Restriction Classes	5
Extension Groups	8
Message Waitings	8 per extension

Section 6

Troubleshooting

6.1 *While Installing*

PROBLEM	PROBABLE CAUSE	POSSIBLE SOLUTION
Extension does not operate.	<p>Something is wrong with the printed circuit board (Extension Card).</p> <p>Something is wrong with the connection between the system and extension.</p> <p>A telephone with an A-A1 relay is connected.</p> <p>Something is wrong with the extension.</p>	<p>Exchange the printed circuit board with another printed circuit board.</p> <p>Take the extension and plug it into the same extension port using a short telephone cord. If the telephone works correctly, the connection between the system and the extension must be repaired.</p> <p>Use a 2 wire cord. Set the A-A1 relay switch on the telephone to the "OUT" or "OFF" position.</p> <p>Take the extension and plug it into another extension port that is working. If the telephone does not work, replace the phone.</p>
Improper reset operation.		Turn the Power Switch "OFF" and then "ON".
Noise during external paging.	Induced noise on the wire between the system and the amplifier.	Use a shielded cable as the connection wire between the system and amplifier. A short shielded cable is recommended.
Volume distortion from external music source.	Excessive input level from external music source.	Decrease the output level of the external music source by using the volume control on the music source.
Speed Dialing or One-Touch Dialing does not function.	Wrong programming.	Enter an outside line access number (9 or 0, 81 through 86) in programming.
A proprietary telephone connected to extension jacks 01 through 08 or 09 through 16 does not operate, but a single line telephone operates.	An extension (H, L) jack 01 through 08 or 09 through 16 may have been shorted.	Turn the Power Switch "OFF". Fix the shorted part, then turn the Power Switch "ON".

6.3 While Operating

PROBLEM	PROBABLE CAUSE	POSSIBLE SOLUTION
When using the speakerphone with a proprietary telephone, KX-T7030, KX-T7130, KX-T7330 or KX-T7033, nothing is heard.	The HANDSET/HEADSET selector on the KX-T7030, KX-T7130, KX-T7330 or KX-T7033 is set to the "HEADSET" position.	When the headset is not used, set the HANDSET/HEADSET selector to the "HANDSET" position.
The unit does not ring.	The Ringer Volume Selector is set to "OFF".	Set to "HIGH" or "LOW".
During a power failure, the extension connected to jack number 01 or 09 does not operate.	A proprietary telephone is connected to the jack.	Disconnect the proprietary telephone and connect a single line telephone.
Making an outside call cannot be performed.	The corresponding CO button does not exist on the proprietary telephone.	Program the CO button. See the Flexible Button Assignment. (☞ Operating Instructions, 1.2 Proprietary Telephone Settings, "Customizing the Buttons on Your Telephone")
A tone type single line telephone (SLT) user cannot make a call.	There may be something wrong with a DTMF receiver.	<ol style="list-style-type: none"> 1. Select "Enable" for DTMF receiver 1 and "Disable" for DTMF receiver 2 in program [107]. 2. Make a call using a tone type SLT connected to one of extension jacks 01–08. 3. If you cannot make the call, the problem may have been caused by DTMF receiver 1. If the call can be made, go to step 4. 4. Try DTMF receiver 2. Select "Disable" for DTMF receiver 1 and "Enable" for DTMF receiver 2 in program [107], and make another call. If you cannot make the call, the problem may have been caused by DTMF receiver 2. If the call can be made, go to step 5. 5. Check the other 4 DTMF receivers in the same way. Refer to program [107].

Section 7
Programming Tables

7 Programming Tables

[000] Date and Time Setting							
	Year (00 – 99)	Month (Jan. – Dec.)	Day (1 – 31)	Day of the week (Sun – Sat)	Hour (1 – 12)	Minute (00 – 59)	AM / PM
Default	'98	Jan.	1	Thu	12	00	AM
Change							

[002] System Password				
Default				Parameter: 4 digits, 0 – 9
1	2	3	4	

	[003] DSS Console Port Assignment	[004] Paired Telephone Assignment for DSS Console
Selection	DSS console jack no. (02...16) / Disable	Paired telephone jack no. (01...16) / Disable
Default	All: Disable	DSS 1 – Disable / DSS 2 – Disable
DSS 1		
DSS 2		

[005] One-Touch Transfer Using a DSS Button		
	Default	Selection
With Transfer	✓	
Without Transfer		

[006] Time (Day/Night/Lunch) Service Changing Mode		
	Default	Selection
Manually	✓	
Automatically		

[007] Time (Day/Night/Lunch) Service Start Time									
	Default	Change							
	Every day	Every day	Sun.	Mon.	Tue.	Wed.	Thu.	Fri.	Sat.
Day	9:00 AM								
Night	5:00 PM								
Lunch-S	None								
Lunch-E	None								

[008] Operator Assignment		
	Default	Jack no.
Operator	Jack-01	

[010] LCD Time Display Selection		
	Default	Selection
12 HOUR	✓	
24 HOUR		

7 *Programming Tables*

SPD no.	[001] System Speed Dialing Entry	[011] System Speed Dialing Name Setting
	Telephone no. (32 digits max.)	Name (16 characters max.)
Default	All: Not stored	
00		
01		
02		
03		
04		
05		
06		
07		
08		
09		
10		
11		
12		
13		
14		
15		
16		
17		
18		
19		
20		
21		
22		
23		
24		
25		
26		
27		
28		
29		
30		
31		
32		
33		
34		
35		
36		
37		
38		
39		

(Continued)

7 *Programming Tables*

SPD no.	[001] System Speed Dialing Entry	[011] System Speed Dialing Name Setting
	Telephone no. (32 digits max.)	Name (16 characters max.)
Default	All: Not stored	
40		
41		
42		
43		
44		
45		
46		
47		
48		
49		
50		
51		
52		
53		
54		
55		
56		
57		
58		
59		
60		
61		
62		
63		
64		
65		
66		
67		
68		
69		
70		
71		
72		
73		
74		
75		
76		
77		
78		
79		

(Continued)

7 *Programming Tables*

SPD no.	[001] System Speed Dialing Entry	[011] System Speed Dialing Name Setting
	Telephone no. (32 digits max.)	Name (16 characters max.)
Default	All: Not stored	
80		
81		
82		
83		
84		
85		
86		
87		
88		
89		
90		
91		
92		
93		
94		
95		
96		
97		
98		
99		

7 *Programming Tables*

[009] Extension Number Assignment						
Selection	Plan 1		Plan 2		Plan 3	
Default	✓					
Change						
Extension jack no.	Extension no. (100...199)		Extension no. (100...499)		Extension no. (10...49)	
	Default	Change	Default	Change	Default	Change
01	101		101		11	
02	102		102		12	
03	103		103		13	
04	104		104		14	
05	105		105		15	
06	106		106		16	
07	107		107		17	
08	108		108		18	
09	109		109		19	
10	110		110		20	
11	111		111		21	
12	112		112		22	
13	113		113		23	
14	114		114		24	
15	115		115		25	
16	116		116		26	
17	117		117		27	
18	118		118		28	
19	119		119		29	
20	120		120		30	
21	121		121		31	
22	122		122		32	
23	123		123		33	
24	124		124		34	

[012] Second Feature Numbering Plan			
CODE no.	Feature no. (10 digits max.)	CODE no.	Feature no. (10 digits max.)
Default: All	Not stored		
50		55	
51		56	
52		57	
53		58	
54		59	

7 Programming Tables

[100] Hunting Group Set										
Selection	Default	Extension group no. (1...8, *: all)								
	All	1	2	3	4	5	6	7	8	*
Disable	✓									
Enable										

[101] Hunting Type										
Selection	Default	Extension group no. (1...8, *: all)								
	All	1	2	3	4	5	6	7	8	*
Terminate	✓									
Circular										

	[102] Voice Mail Port for KX-TVP75/KX-TVP100						[107] DTMF Receiver Check							
	Default	Extn. jack no. (07, 08, 15, 16, *: all)					Default	DTMF receiver no. (1...6)						
	All	07	08	15	16	*	All	1	2	3	4	5	6	
Disable	✓													
Enable							✓							

	[103] DTMF Integration for KX-TVP75/KX-TVP100		[104] Hold Mode Selection			[105] Conference Tone		[106] External Paging Access Tone	
	Enable	Disable	Hold-1	Hold-2	Hold-3	Enable	Disable	Enable	Disable
	Default		✓	✓			✓		✓
Change									

	[108] Flash Mode for a Station Locked Extension		[109] CO Indicator Assignment		[110] Flash Key Mode		[111] Hold Music Selection		
	Enable	Disable	Enable	Disable	MODE 1	MODE 2	Internal	External	Tone
	Default		✓	✓		✓		✓	
Change									

	[112] DSS Console Indication Mode		[113] Automatic Redial Repeat				[114] Automatic Redial Interval Time	
	Enable	Disable	0 time	3 times	10 times	15 times	40 sec	60 sec
	Default	✓				✓		
Change								

7 Programming Tables

Selection	[115] Extension Ringing Pattern Selection			[116] Conference Pattern Selection			
	Single	Double	Triple	3-Party C-0 E-3	3-Party C-1 E-3	3-Party C-2 E-3	5-Party C-2 E-5
Default		✓					✓
Change							

Selection	[117] Call Pickup Tone		[118] Pulse Restriction		[119] Redialing after Pulse to Tone Conversion		[120] Bell Frequency	
	Enable	Disable	Enable	Disable	Enable	Disable	20 Hz	25 Hz
Default	✓		✓			✓		✓
Change								

Selection	[121] Automatic Outside (CO) Line Access Number Selection		[122] Automatic Rotation for Outside (CO) Line Access	
	Dial 0	Dial 9	Enable	Disable
Default		✓		✓
Change				

Selection	[123] Break Ratio		[124] SLT Ringing Mode Selection		[125] Toll Restriction Check for * and #		[126] DSS Off-Hook Mode	
	MODE 1	MODE 2	MODE 1	MODE 2	Enable	Disable	Enable	Disable
Default	✓		✓		✓		✓	
Change								

[127] Pickup Group Set										
Selection	Default	Extension group no. (1...8, * : all)								
	All	1	2	3	4	5	6	7	8	*
Disable	✓									
Enable										

7 Programming Tables

[200] Hold Recall Time									
Selection	30 sec	1 min	1.5 min	2 min	3 min	4 min	5 min	6 min	Disable
Default	✓								
Change									

	[201] Transfer Recall Time				[202] Call Forwarding Start Time				[203] Pickup Dial Delay Time			
	Selection	15 sec	30 sec	1 min	2 min	5 sec	10 sec	15 sec	20 sec	1 sec	2 sec	3 sec
Default		✓					✓				✓	
Change												

[204] Call Duration Count Start Time											
Selection	5 sec	10 sec	15 sec	20 sec	25 sec	30 sec	35 sec	40 sec	45 sec	50 sec	Instantly
Default		✓									
Change											

	[205] Outside to Outside (CO to CO) Line Duration Time Limit	[206] Dialing Start Time						
	Selection	1...32 minutes	0 ms	250 ms	500 ms	750 ms	1000 ms	1250 ms
Default	10 minutes	✓						
Change								

	[207] Hookswitch Flash Timing Range Selection					[208] Interdigit Time			
	Selection	MODE 1	MODE 2	MODE 3	MODE 4	MODE 5	5 sec	10 sec	15 sec
Default				✓			✓		
Change									

	[210] DTMF Time		[211] No Dial Disconnection		[212] Outside (CO) Line Duration Time Limit	[213] Bell Off Detection		
	Selection	MODE 1	MODE 2	Enable	Disable	1...32 minutes	3 sec	6 sec
Default	✓			✓	10 minutes		✓	
Change								

7 *Programming Tables*

[300] Carrier Excepted Code Assignment			
CODE no.	Carrier code (10 digits max.)	CODE no.	Carrier code (10 digits max.)
Default: All	Not stored		
01		11	
02		12	
03		13	
04		14	
05		15	
06		16	
07		17	
08		18	
09		19	
10		20	

[301] Toll Restriction — System Speed Dialing Boundary Class					
Selection	Class-1	Class-2	Class-3	Class-4	Class-5
Default	✓				
Change					

	[302] Toll Restriction – Class 2 Denied Codes	[303] Toll Restriction – Class 3 Denied Codes	[304] Toll Restriction – Class 4 Denied Codes	[305] Toll Restriction – Class 5 Denied Codes
CODE no.	Telephone no. (11 digits)			
Default	All: Not stored			
01				
02				
03				
04				
05				
06				
07				
08				
09				
10				
11				
12				
13				
14				
15				
16				
17				
18				
19				
20				

7 *Programming Tables*

[306] Toll Restriction – Exception Codes			
CODE no.	Telephone no. (11 digits)	CODE no.	Telephone no. (11 digits)
Default	All: Not stored		
01		41	
02		42	
03		43	
04		44	
05		45	
06		46	
07		47	
08		48	
09		49	
10		50	
11		51	
12		52	
13		53	
14		54	
15		55	
16		56	
17		57	
18		58	
19		59	
20		60	
21		61	
22		62	
23		63	
24		64	
25		65	
26		66	
27		67	
28		68	
29		69	
30		70	
31		71	
32		72	
33		73	
34		74	
35		75	
36		76	
37		77	
38		78	
39		79	
40		80	

7 *Programming Tables*

[309] Emergency Dial Number Set	
CODE no.	Emergency no. (11 digits max.)
Default	All: Not stored
1	
2	
3	
4	
5	

[310] Account Codes			
CODE no.	Account code (4 digits)	CODE no.	Account code (4 digits)
Default	All: Not stored		
01		13	
02		14	
03		15	
04		16	
05		17	
06		18	
07		19	
08		20	
09		21	
10		22	
11		23	
12		24	

7 *Programming Tables*

[311] Automatic Pause Insertion Codes			
CODE no.	Pause code (7 digits max.)	CODE no.	Pause code (7 digits max.)
Default	All: Not stored		
01		21	
02		22	
03		23	
04		24	
05		25	
06		26	
07		27	
08		28	
09		29	
10		30	
11		31	
12		32	
13		33	
14		34	
15		35	
16		36	
17		37	
18		38	
19		39	
20		40	

[312] Toll Restriction – Station Lock Boundary Class		
	Default	Change
Disable	✓	
COS-2		
COS-3		
COS-4		
COS-5		

[350] ARS Selection								
Selection	Default	Outside line no. (1...6, *: All)						
	All	1	2	3	4	5	6	*
Enable								
Disable	✓							

7 *Programming Tables*

[351] Route 1 Selection Codes (Leading Digits)			
Code no.	Area code no. (7 digits max.)	Code no.	Area code no. (7 digits max.)
Default	All: Not stored		
01		41	
02		42	
03		43	
04		44	
05		45	
06		46	
07		47	
08		48	
09		49	
10		50	
11		51	
12		52	
13		53	
14		54	
15		55	
16		56	
17		57	
18		58	
19		59	
20		60	
21		61	
22		62	
23		63	
24		64	
25		65	
26		66	
27		67	
28		68	
29		69	
30		70	
31		71	
32		72	
33		73	
34		74	
35		75	
36		76	
37		77	
38		78	
39		79	
40		80	

7 *Programming Tables*

[352] Route 2 Selection Codes (Leading Digits)			
Code no.	Area code no. (7 digits max.)	Code no.	Area code no. (7 digits max.)
Default	All: Not stored		
01		41	
02		42	
03		43	
04		44	
05		45	
06		46	
07		47	
08		48	
09		49	
10		50	
11		51	
12		52	
13		53	
14		54	
15		55	
16		56	
17		57	
18		58	
19		59	
20		60	
21		61	
22		62	
23		63	
24		64	
25		65	
26		66	
27		67	
28		68	
29		69	
30		70	
31		71	
32		72	
33		73	
34		74	
35		75	
36		76	
37		77	
38		78	
39		79	
40		80	

7 *Programming Tables*

[353] Route 3 Selection Codes (Leading Digits)			
Code no.	Area code no. (7 digits max.)	Code no.	Area code no. (7 digits max.)
Default	All: Not stored		
01		41	
02		42	
03		43	
04		44	
05		45	
06		46	
07		47	
08		48	
09		49	
10		50	
11		51	
12		52	
13		53	
14		54	
15		55	
16		56	
17		57	
18		58	
19		59	
20		60	
21		61	
22		62	
23		63	
24		64	
25		65	
26		66	
27		67	
28		68	
29		69	
30		70	
31		71	
32		72	
33		73	
34		74	
35		75	
36		76	
37		77	
38		78	
39		79	
40		80	

7 *Programming Tables*

[354] Route 4 Selection Codes (Leading Digits)			
Code no.	Area code no. (7 digits max.)	Code no.	Area code no. (7 digits max.)
Default	All: Not stored		
01		41	
02		42	
03		43	
04		44	
05		45	
06		46	
07		47	
08		48	
09		49	
10		50	
11		51	
12		52	
13		53	
14		54	
15		55	
16		56	
17		57	
18		58	
19		59	
20		60	
21		61	
22		62	
23		63	
24		64	
25		65	
26		66	
27		67	
28		68	
29		69	
30		70	
31		71	
32		72	
33		73	
34		74	
35		75	
36		76	
37		77	
38		78	
39		79	
40		80	

7 *Programming Tables*

[355] Route 1 Exception Codes			
Code no.	Area code no. (7 digits max.)	Code no.	Area code no. (7 digits max.)
Default	All: Not stored		
01		41	
02		42	
03		43	
04		44	
05		45	
06		46	
07		47	
08		48	
09		49	
10		50	
11		51	
12		52	
13		53	
14		54	
15		55	
16		56	
17		57	
18		58	
19		59	
20		60	
21		61	
22		62	
23		63	
24		64	
25		65	
26		66	
27		67	
28		68	
29		69	
30		70	
31		71	
32		72	
33		73	
34		74	
35		75	
36		76	
37		77	
38		78	
39		79	
40		80	

7 *Programming Tables*

[356] Route 2 Exception Codes			
Code no.	Area code no. (7 digits max.)	Code no.	Area code no. (7 digits max.)
Default	All: Not stored		
01		41	
02		42	
03		43	
04		44	
05		45	
06		46	
07		47	
08		48	
09		49	
10		50	
11		51	
12		52	
13		53	
14		54	
15		55	
16		56	
17		57	
18		58	
19		59	
20		60	
21		61	
22		62	
23		63	
24		64	
25		65	
26		66	
27		67	
28		68	
29		69	
30		70	
31		71	
32		72	
33		73	
34		74	
35		75	
36		76	
37		77	
38		78	
39		79	
40		80	

7 *Programming Tables*

[357] Route 3 Exception Codes			
Code no.	Area code no. (7 digits max.)	Code no.	Area code no. (7 digits max.)
Default	All: Not stored		
01		41	
02		42	
03		43	
04		44	
05		45	
06		46	
07		47	
08		48	
09		49	
10		50	
11		51	
12		52	
13		53	
14		54	
15		55	
16		56	
17		57	
18		58	
19		59	
20		60	
21		61	
22		62	
23		63	
24		64	
25		65	
26		66	
27		67	
28		68	
29		69	
30		70	
31		71	
32		72	
33		73	
34		74	
35		75	
36		76	
37		77	
38		78	
39		79	
40		80	

7 *Programming Tables*

[358] Route 4 Exception Codes			
Code no.	Area code no. (7 digits max.)	Code no.	Area code no. (7 digits max.)
Default	All: Not stored		
01		41	
02		42	
03		43	
04		44	
05		45	
06		46	
07		47	
08		48	
09		49	
10		50	
11		51	
12		52	
13		53	
14		54	
15		55	
16		56	
17		57	
18		58	
19		59	
20		60	
21		61	
22		62	
23		63	
24		64	
25		65	
26		66	
27		67	
28		68	
29		69	
30		70	
31		71	
32		72	
33		73	
34		74	
35		75	
36		76	
37		77	
38		78	
39		79	
40		80	

7 Programming Tables

[359] 1st Carrier Selection Code	
Selection	1st carrier access code (4 digits max.)
Default	000
Change	

Route no.	[360] ARS Modification – Removed Digits	[361] ARS Modification – Added Number	[364] ARS Outside (CO) Line Group						
	Deleted digits (0...9)	Added no. : 20 digits max. (0...9, *, #)	Outside line (TRK) group no. (1...6, *)						
			1	2	3	4	5	6	*
Default	All routes – 0	All routes – Not stored	All routes – *						
1									
2									
3									
4									

Selection	[362] ARS Dial Tone Pattern Selection				[363] ARS Interdigit Time
	Disable	Tone 1	Tone 2	Tone 3	1...20 seconds
Default		✓			5 seconds
Change					

Outside line no.	[400] Outside (CO) Line Connection Assignment		[401] Dial Mode			[402] Pulse Speed Selection	
	Connect	No Connect	DTMF	Pulse	Call Blocking	Low Speed	High Speed
Default: All	✓			✓		✓	
1							
2							
3							
4							
5							
6							
*							

7 Programming Tables

Outside line no.	[403] Host PBX Access Codes								[404] Outside (CO) Line Group Assignment	
	Access codes (1 or 2 digits, 8 different codes max.)								Outside line (TRK) group no. (1...6)	
Default	All: Not stored								Default	Change
1									1	
2									2	
3									3	
4									4	
5									5	
6									6	
*									—	

[405] Flexible Outward Dialing Assignment — Day														
Extension jack no.	Outside line 1		Outside line 2		Outside line 3		Outside line 4		Outside line 5		Outside line 6		* (All)	
	Selection													
	Enable	Disable	Enable	Disable	Enable	Disable	Enable	Disable	Enable	Disable	Enable	Disable	Enable	Disable
Default: All	✓		✓		✓		✓		✓		✓		✓	
01														
02														
03														
04														
05														
06														
07														
08														
09														
10														
11														
12														
13														
14														
15														
16														
17														
18														
19														
20														
21														
22														
23														
24														
*														

7 *Programming Tables*

[406] Flexible Outward Dialing Assignment — Night														
Extension jack no.	Outside line 1		Outside line 2		Outside line 3		Outside line 4		Outside line 5		Outside line 6		* (All)	
	Selection													
	Enable	Disable	Enable	Disable	Enable	Disable	Enable	Disable	Enable	Disable	Enable	Disable	Enable	Disable
Default: All	✓		✓		✓		✓		✓		✓		✓	
01														
02														
03														
04														
05														
06														
07														
08														
09														
10														
11														
12														
13														
14														
15														
16														
17														
18														
19														
20														
21														
22														
23														
24														
*														

7 *Programming Tables*

[407] Flexible Outward Dialing Assignment — Lunch															
Extension jack no.	Outside line 1		Outside line 2		Outside line 3		Outside line 4		Outside line 5		Outside line 6		* (All)		
	Selection														
	Enable	Disable	Enable	Disable	Enable	Disable	Enable	Disable	Enable	Disable	Enable	Disable	Enable	Disable	
Default: All	✓		✓		✓		✓		✓		✓		✓		
01															
02															
03															
04															
05															
06															
07															
08															
09															
10															
11															
12															
13															
14															
15															
16															
17															
18															
19															
20															
21															
22															
23															
24															
*															

7 *Programming Tables*

[408] Flexible Ringing Assignment — Day														
Extension jack no.	Outside line 1		Outside line 2		Outside line 3		Outside line 4		Outside line 5		Outside line 6		× (All)	
	Selection													
	Enable	Disable	Enable	Disable	Enable	Disable	Enable	Disable	Enable	Disable	Enable	Disable	Enable	Disable
Default: All	✓		✓		✓		✓		✓		✓		✓	
01														
02														
03														
04														
05														
06														
07														
08														
09														
10														
11														
12														
13														
14														
15														
16														
17														
18														
19														
20														
21														
22														
23														
24														
*														

7 *Programming Tables*

[409] Flexible Ringing Assignment — Night															
Extension jack no.	Outside line 1		Outside line 2		Outside line 3		Outside line 4		Outside line 5		Outside line 6		* (All)		
	Selection														
	Enable	Disable	Enable	Disable	Enable	Disable	Enable	Disable	Enable	Disable	Enable	Disable	Enable	Disable	
Default: All	✓		✓		✓		✓		✓		✓		✓		
01															
02															
03															
04															
05															
06															
07															
08															
09															
10															
11															
12															
13															
14															
15															
16															
17															
18															
19															
20															
21															
22															
23															
24															
*															

7 *Programming Tables*

[410] Flexible Ringing Assignment — Lunch														
Extension jack no.	Outside line 1		Outside line 2		Outside line 3		Outside line 4		Outside line 5		Outside line 6		* (All)	
	Selection													
	Enable	Disable	Enable	Disable	Enable	Disable	Enable	Disable	Enable	Disable	Enable	Disable	Enable	Disable
Default: All	✓		✓		✓		✓		✓		✓		✓	
01														
02														
03														
04														
05														
06														
07														
08														
09														
10														
11														
12														
13														
14														
15														
16														
17														
18														
19														
20														
21														
22														
23														
24														
*														

7 *Programming Tables*

[411] Delayed Ringing Assignment — Day																																
Extension jack no.	Outside line 1				Outside line 2				Outside line 3				Outside line 4				Outside line 5				Outside line 6				* (All)							
	Selection (I: Immediately, 5: 5 seconds delay, 10: 10 seconds delay, 15: 15 seconds delay)																															
	I	5	10	15	I	5	10	15	I	5	10	15	I	5	10	15	I	5	10	15	I	5	10	15	I	5	10	15	I	5	10	15
Default: All	✓				✓				✓				✓				✓				✓				✓				✓			
01																																
02																																
03																																
04																																
05																																
06																																
07																																
08																																
09																																
10																																
11																																
12																																
13																																
14																																
15																																
16																																
17																																
18																																
19																																
20																																
21																																
22																																
23																																
24																																
*																																

7 Programming Tables

[412] Delayed Ringing Assignment — Night																												
Extension jack no.	Outside line 1			Outside line 2			Outside line 3			Outside line 4			Outside line 5			Outside line 6			* (All)									
	Selection (I: Immediately, 5: 5 seconds delay, 10: 10 seconds delay, 15: 15 seconds delay)																											
	I	5	10	15	I	5	10	15	I	5	10	15	I	5	10	15	I	5	10	15	I	5	10	15				
Default: All	✓				✓				✓				✓				✓				✓				✓			
01																												
02																												
03																												
04																												
05																												
06																												
07																												
08																												
09																												
10																												
11																												
12																												
13																												
14																												
15																												
16																												
17																												
18																												
19																												
20																												
21																												
22																												
23																												
24																												
*																												

7 *Programming Tables*

[413] Delayed Ringing Assignment — Lunch																																
Extension jack no.	Outside line 1				Outside line 2				Outside line 3				Outside line 4				Outside line 5				Outside line 6				* (All)							
	Selection (I: Immediately, 5: 5 seconds delay, 10: 10 seconds delay, 15: 15 seconds delay)																															
	I	5	10	15	I	5	10	15	I	5	10	15	I	5	10	15	I	5	10	15	I	5	10	15	I	5	10	15	I	5	10	15
Default: All	✓				✓				✓				✓				✓				✓				✓				✓			
01																																
02																																
03																																
04																																
05																																
06																																
07																																
08																																
09																																
10																																
11																																
12																																
13																																
14																																
15																																
16																																
17																																
18																																
19																																
20																																
21																																
22																																
23																																
24																																
*																																

7 Programming Tables

Outside line no.	[414] Outside (CO) Line Mode — Day						[415] Outside (CO) Line Mode — Night						[416] Outside (CO) Line Mode — Lunch					
	N	DIL	Extn. no.	D1	D2	U	N	DIL	Extn. no.	D1	D2	U	N	DIL	Extn. no.	D1	D2	U
Default: All	✓						✓						✓					
1																		
2																		
3																		
4																		
5																		
6																		
*																		

Outside line no.	[417] Pause Time				[418] Flash Time							
	Selection (seconds)				Selection (milliseconds)							
	1.5	2.5	3.5	4.5	80	100	160	300	600	900	1200	
Default: All	✓								✓			
1												
2												
3												
4												
5												
6												
*												

Outside line no.	[419] Automatic Designated Outside (CO) Line Access		[420] Calling Party Control (CPC) Signal		[421] CPC Detection for Outgoing Calls	
	Enable	Disable	Selection: 00 (Disable), 01 (22 msec)···75 (614 msec)		Enable	Disable
Default: All	✓		00 (Disable)			✓
1						
2						
3						
4						
5						
6						
*						

7 Programming Tables

	[422] Disconnect Time			[423] Outside (CO) Line Ringing Pattern Selection			[424] Reverse (Polarity) Circuit Assignment	
	Selection (seconds)			Selection			Selection	
Outside line no.	0.5	1.5	4.0	Single	Double	Triple	Enable	Disable
Default: All		✓		✓				✓
1								
2								
3								
4								
5								
6								
*								

[500] DISA Incoming Dialing Mode Selection		
Selection	Without AA	With AA
Default	✓	
Change		

[501] DISA Built-in Auto Attendant		
Auto attendant no.	Selection	
	Jack: Extension jack no. (01...24)	GRP: Extension group no. (1...8)
Default	All: Not stored	
0		
1		
2		
3		
4		
5		
6		
7		
8		
9		

7 Programming Tables

	[502] OGM Mode Selection						[503] FAX Connection	
Selection	MODE 1	MODE 2	MODE 3	MODE 4	MODE 5	MODE 6	Extension jack no. (01...24) / Disable	
Default	✓						Disable (Not assigned)	
Change								

	[504] DISA Delayed Answer Time				[505] DISA Waiting Time after OGM			
Selection	0 sec	3 sec	6 sec	12 sec	0 sec	5 sec	10 sec	15 sec
Default		✓				✓		
Change								

	[506] DISA Busy Mode			[507] DISA Intercept Mode		[508] DISA Ringing Time before Intercept					
Selection	Disconnect	Call Waiting	DISA 2	Intercept	Disconnect	10 sec	20 sec	30 sec	40 sec	60 sec	120 sec
Default	✓			✓			✓				
Change											

	[509] DISA Ringing Time after Intercept						[510] DISA No Dial Mode			
Selection	10 sec	20 sec	30 sec	40 sec	60 sec	120 sec	DISA 1		DISA 2	
							Intercept	Disconnect	Intercept	Disconnect
Default		✓					✓		✓	
Change										

	[511] DISA Security Type			[512] DISA Security Codes				[513] Cyclic Tone Detection			
Selection	Trunk	All	None	0...9, 4 digit				Disable	2 Times	3 Times	4 Times
Default	✓			All codes: Not stored							✓
Change				CODE=01	CODE=02	CODE=03	CODE=04				

	[514] FAX Tone Detection		[515] Intercept Time for Internal DISA			[517] DISA AA Wait Time				
Selection	1 Time	2 Times	3 sec	6 sec	9 sec	1 sec	2 sec	3 sec	4 sec	5 sec
Default	✓		✓				✓			
Change										

7 Programming Tables

[516] DISA Incoming Assignment					
Extension jack no.	Selection		Extension jack no.	Selection	
	Enable	Disable		Enable	Disable
Default: All	✓		13		
01			14		
02			15		
03			16		
04			17		
05			18		
06			19		
07			20		
08			21		
09			22		
10			23		
11			24		
12			✳		

	[518] DISA Tone Selection after the Security Code		[519] DISA OGM Mute Time				[520] UCD Group
	Enable	Disable	0 sec	2 sec	4 sec	6 sec	Extension group no. (1...8)
Selection							
Default	✓		✓				1
Change							

	[521] UCD Busy Waiting Time	[522] UCD OGM Message Interval Time				[523] UCD Busy Mode	
	1...32 minutes, 1...59 seconds	30 sec	1 min	1.5 min	2 min	Intercept	Disconnect
Selection							
Default	10 minutes		✓			✓	
Change							

	[524] UCD Intercept Mode		[525] UCD Ringing Time before Intercept					
	Intercept	Disconnect	10 sec	20 sec	30 sec	40 sec	60 sec	120 sec
Selection								
Default	✓			✓				
Change								

[526] UCD Ringing Time after Intercept						
Selection	10 sec	20 sec	30 sec	40 sec	60 sec	120 sec
Default		✓				
Change						

7 *Programming Tables*

Extension jack no.	[600] Extension Group Assignment								[604] Extension Name Setting
	Extension group no. (1...8)								Extension name (10 character max.) Default: All – Not stored
	1	2	3	4	5	6	7	8	
01									
02									
03									
04									
05									
06									
07									
08									
09									
10									
11									
12									
13									
14									
15									
16									
17									
18									
19									
20									
21									
22									
23									
24									
*									

7 *Programming Tables*

Extension jack no.	[601] TRS – Class of Service Assignment — Day					[602] TRS – Class of Service Assignment — Night					[603] TRS – Class of Service Assignment — Lunch				
	COS no. (1...5)					COS no. (1...5)					COS no. (1...5)				
	1	2	3	4	5	1	2	3	4	5	1	2	3	4	5
Default: All	✓					✓					✓				
01															
02															
03															
04															
05															
06															
07															
08															
09															
10															
11															
12															
13															
14															
15															
16															
17															
18															
19															
20															
21															
22															
23															
24															
*															

7 *Programming Tables*

Extension jack no.	[605] Account Code Entry Mode				[606] Call Transfer to an Outside (CO) Line		[607] Call Forwarding to an Outside (CO) Line	
	Selection				Selection		Selection	
	Option	Forced	Verify-All	Verify-Toll	Enable	Disable	Enable	Disable
Default: All	✓					✓		✓
01								
02								
03								
04								
05								
06								
07								
08								
09								
10								
11								
12								
13								
14								
15								
16								
17								
18								
19								
20								
21								
22								
23								
24								
*								

7 *Programming Tables*

Extension jack no.	[608] Executive Busy Override		[609] Do Not Disturb Override		[610] Paralleled Telephone Connection		[611] TAM Extension	
	Selection		Selection		Selection		Selection	
	Enable	Disable	Enable	Disable	Enable	Disable	Enable	Disable
Default: All		✓		✓		✓		✓
01								
02								
03								
04								
05								
06								
07								
08								
09								
10								
11								
12								
13								
14								
15								
16								
17								
18								
19								
20								
21								
22								
23								
24								
*								

7 *Programming Tables*

Extension jack no.	[612] Room Monitor Assignment		[613] Outside (CO) Line Duration Time Limit Selection		[614] Internal Pulse Detection		[615] LCD Language Assignment	
	Selection		Selection		Selection		Selection	
	Enable	Disable	Enable	Disable	Enable	Disable	English	Spanish
Default: All		✓		✓	✓		✓	
01								
02								
03								
04								
05								
06								
07								
08								
09								
10								
11								
12								
13								
14								
15								
16								
17	X						X	
18								
19	X						X	
20								
21	X						X	
22								
23	X						X	
24								
*								

7 Programming Tables

Extension jack no.	[700] Doorphone Ringing Assignment — Day				[701] Doorphone Ringing Assignment — Night				[702] Doorphone Ringing Assignment — Lunch							
	1...4: Doorphone no., E: Enable / D: Disable															
	1	2	3	4	1	2	3	4	1	2	3	4				
	E	D	E	D	E	D	E	D	E	D	E	D	E	D	E	D
Default: All	✓		✓		✓		✓		✓		✓		✓		✓	
01																
02																
03																
04																
05																
06																
07																
08																
09																
10																
11																
12																
13																
14																
15																
16																
17																
18																
19																
20																
21																
22																
23																
24																
*																

7 Programming Tables

Extension jack no.	[703] Door Opener Assignment — Day								[704] Door Opener Assignment — Night								[705] Door Opener Assignment — Lunch							
	1...4: Door opener no., E: Enable / D: Disable																							
	1		2		3		4		1		2		3		4		1		2		3		4	
	E	D	E	D	E	D	E	D	E	D	E	D	E	D	E	D	E	D	E	D	E	D	E	D
Default: All		✓				✓					✓					✓					✓			
01																								
02																								
03																								
04																								
05																								
06																								
07																								
08																								
09																								
10																								
11																								
12																								
13																								
14																								
15																								
16																								
17																								
18																								
19																								
20																								
21																								
22																								
23																								
24																								
*																								

Doorphone no.	[706] Doorphone Ringing / Tone Pattern Selection				[707] Doorphone Access Tone Selection		[708] Doorphone Ringing Time	
	Selection				Selection		Selection	
	Single	Double	Triple	S-Double	Enable	Disable	15 sec	30 sec
Default: All			✓		✓		✓	
1								
2								
3								
4								
*								

7 Programming Tables

[709] Door Opener Time								
Door opener no.	Selection							
	1 sec	2 sec	3 sec	4 sec	5 sec	6 sec	7 sec	8 sec
Default: All					✓			
1								
2								
3								
4								
*								

[800] SMDR RS-232C Communication Parameters																		
Selection	New line code		Baud rate							Word length		Parity					Stop bit	
	CR+LF	CR	150	300	600	1200	2400	4800	9600	7	8	Mark	Space	Even	Odd	None	1	2
Default	✓								✓	✓	✓						✓	
Change																		

[801] SMDR Parameter		
	Default	Selection
Page length (4...99)	66	
Skip perforation (0...95)	0	

[802] Incoming/Outgoing Call Selection for Printing			
		Default	Selection
Incoming calls	On	✓	
	Off		
Outgoing calls	On	✓	
	Off		
	Toll		

	[803] Secret Speed Dialing / One-Touch Dialing Printing		[805] SMDR Account Code Selection		[806] SMDR Language Assignment	
Selection	No Printing	Printing	CODE	INDEX	English	Spanish
Default	✓		✓		✓	
Change						

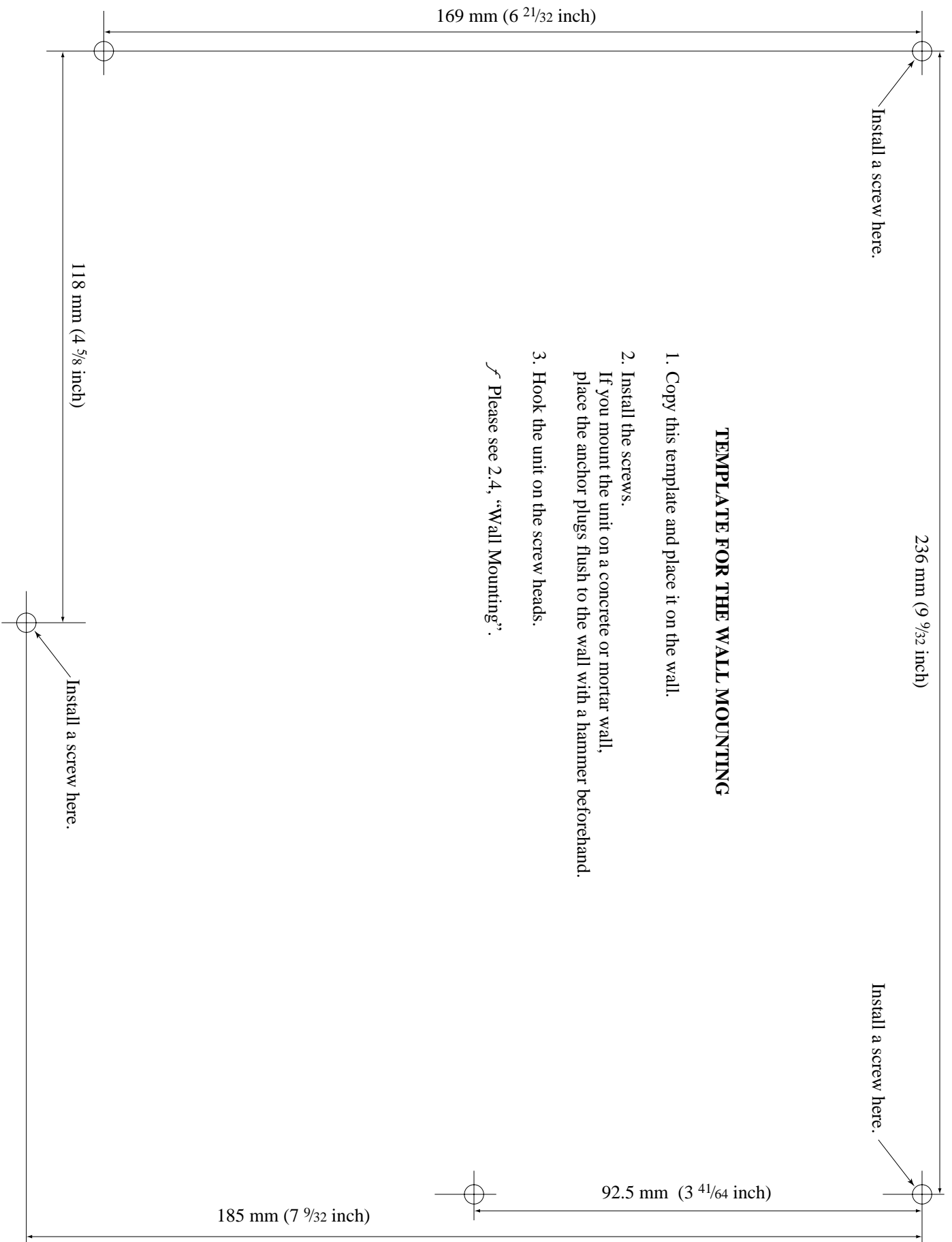

TEMPLATE FOR THE WALL MOUNTING

1. Copy this template and place it on the wall.
 2. Install the screws.
If you mount the unit on a concrete or mortar wall, place the anchor plugs flush to the wall with a hammer beforehand.
 3. Hook the unit on the screw heads.
- ⚠ Please see 2.4, "Wall Mounting".

This unit complies with the EU Directives.

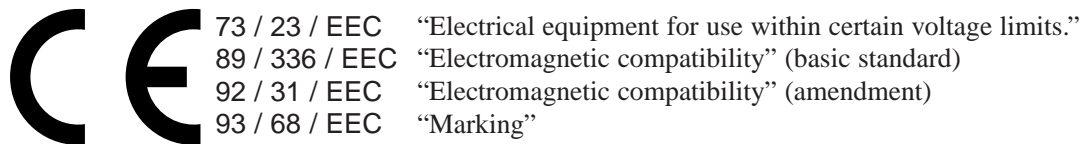

The CE mark on this unit certifies compliance with the above mentioned Directives.

Copyright:

This manual is copyrighted by Kyushu Matsushita Electric Co., Ltd. (KME). Under the copyright laws, this manual may not be reproduced in any form, in whole or part, without the prior written consent of KME.

© Kyushu Matsushita Electric Co., Ltd. 1999

Kyushu Matsushita Electric Co., Ltd.

1-62, 4-chome, Minoshima, Hakata-ku, Fukuoka 812-8531, Japan